

# CSI 6500 Machinery Health™ Monitor

- Extend PlantWeb® with API 670 machinery protection monitoring.
- Integrate machinery protection monitoring with DeltaV™ and Ovation™ automation systems in three easy steps.
- Monitor your plant's most critical rotating machines.
- Gain real-time machinery health feedback integrated with process automation.
- Transform vibration monitoring into predictive alerts.
- Empower decisions through transient analysis of turbines in AMS Suite.
- Balance of plant machinery health monitoring includes PeakVue™ technology for rolling element bearing and gearbox analysis.



*Real-time machinery health feedback integrates with process automation so you can run your plant with confidence.*

## Overview

Five percent of the rotating machines in every plant have the ability to bring production to a grinding halt. Although your critical machines have vibration shutdown protection systems in place to prevent catastrophic failure, is your plant really protected?

What about the shocking repair costs, missed production goals, and unfulfilled customer commitments associated with a trip or a missed trip?

As many as 50% of machinery malfunctions that lead to downtime are process induced, and 90% are predictable – even controllable.

The CSI 6500 Machinery Health Monitor is designed for process automation and protection system upgrade projects. Housed in a single chassis, the CSI 6500 combines proven prediction and protection to provide a complete online machinery monitoring solution. Emerson is the global leader of integrated technologies for process automation and plant-wide predictive technologies for managing both fixed and rotating assets.

The CSI 6500 is fully compliant with API 670 and integrates protection, prediction, real-time performance monitoring and process automation.

The CSI 6500 is part of Emerson's PlantWeb digital architecture, which provides enterprise-wide information needed for realtime decision making.

**Rack Interface Communication**

- Redundant ModBus TCP/IP for integration with any process automation system.
- Simple, single card configuration of all monitors

**Speed, Phase, Overspeed Module**

- Monitors running speed, zero speed, rotor acceleration, enables peak and phase, and can accept standard displacement probes and magnetic speed sensors from single notch to multi-tooth wheel

**16 Channel Relay Module**

- Build up to 60 configurable software expressions using function blocks.
- Graphically create voting logic for Alerts, Danger, OK and Not OK.
- Set time delay, system relays and trip multiply

**Buffered Outputs**

- Outputs raw waveform vibration data for connectivity to the CSI 2130 Analyzer

**2-Channel Microprocessor-based Monitors**

- Extensive self checks, configurable internal temperature set points, indication via OK LED provides key feedback of system health
- Provides industry standard analog input signals to PLC or process automation proportional to vibration levels

**4-20mA Outputs**

- Provides industry standard analog input signals to PLC or process automation proportional to vibration levels

**19" rack, 17 hot swappable Slots, 6U standard height integrated protection system and machinery health monitoring is perfect for project revamps**

- API 670 Compliant
- Integrated protection and prediction monitoring
- Dual, redundant 24VDC, 120–240VAC, 50–60Hz power input
- PlantWeb Enabled: Ovation, DeltaV and AMS Suite Compatible
- Full TSI (turbine supervisory instrumentation)
  - Case Expansion
  - Differential Expansion
  - Thrust Position
  - Relative Vibration
  - Absolute Vibration
- Small 3U protection only rack available

Protect your critical machinery through protection, prediction, performance monitoring, and PlantWeb.

## Flexible for Retrofits

Your project may be a major revamp, including a control system and vibration monitoring system update, or you may be making improvements in phases.

If Phase 1 is only a protection system upgrade, the CSI 6500 is uniquely designed to offer protection-only for obsolete system replacement.

The CSI 6500 can even be deployed in a prediction-only configuration to overlay on an existing protection system.

Want to use your existing instrumentation? The CSI 6500 works with any negative 24 VDC powered displacement sensors and drivers.

In Phase 2 of your project, the prediction-only configuration or protection-only configuration can be upgraded at any time to a combined configuration by simply adding a few monitoring modules. The CSI 6500 offers the most flexible and powerful solution available for retrofit applications.

## A Protection System You Can Count On

The CSI 6500 is field-proven, providing API 670 protection on the industry’s most critical equipment: steam turbine generators, gas turbines, boiler feed pumps, offshore compressors, pipeline turbo compressors, chemical industry compressors, turbo exhausters, blowers, and boosters.

Missed trips, false trips, and running blind are not acceptable in your plant.

The CSI 6500 helps prevent missed trips by using module self-health checking, instrumentation health monitoring and hot swappable, external, redundant power. External power removes heat and user “touches” away from the rack. The same architecture is used in all Emerson process automation and critical SIS systems.

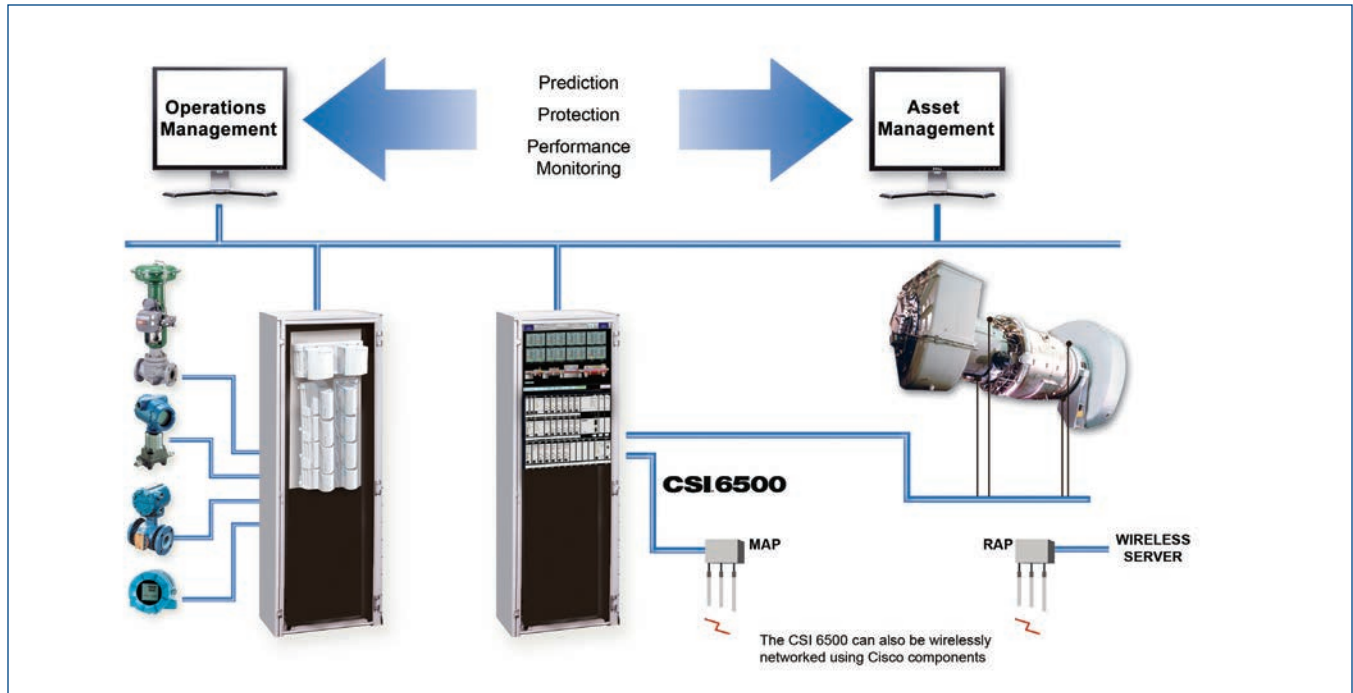

The CSI 6500 is integrated with the Ovation and DeltaV process automation systems through an easy three step process to reduce integration time from weeks to minutes. In addition, control strategies and graphical elements are automatically created, making GUI development a snap.

False trips are addressed through features such as 2oo3 voting logic for increased decision accuracy and limiting channel count to two channel modules. Two channel modules mean that swapping a protection module will affect no more than two channels – an API 670 requirement.

Redundant communications ensures that the operator is never blind to machinery health information.

Other features that demonstrate the flexibility of the CSI 6500 include:

- **Thrust monitoring:** dual channel, complementary, min/max or absolute shaft position, measuring range shift, measuring range invert
- **Differential Expansion:** flexibility for any type of ramp configuration
- **Eccentricity:** max., min., peak to peak, or distance from clearance reference

Integrated Machinery Protection and Prediction from Emerson saves hundreds of man-hours and gives you a complete, error free integration of machinery information with the DeltaV or Ovation digital control system.

Typical machinery protection systems can require 2,400 steps for 24 vibration channels to complete the integration process. It typically takes up to five days for complete integration. With this many steps, network issues, additional testing time, and nuisance alarms are easily introduced. All too often, plants don't have the time or staff to complete the integration, leaving plant operators without key machinery health diagnostics.

The CSI 6500 eliminates this risk by easily providing machinery health diagnostics to operators through the simple three step Easy Integration with your control system.

## Instrumentation

While the CSI 6500 delivers field-based intelligence, accurate information starts with quality instrumentation.

Eddy current displacement sensors are the preferred method for monitoring sleeve-bearing machines. These displacement sensors penetrate the machine case and directly monitor the motion and position of the shaft without contacting the shaft surface.

Accelerometers and velometers are the industry accepted sensors for monitoring the health of gearboxes and rolling element bearings. Although temperature sensors are sometimes used to measure health, temperature alone is only a small part of the machinery health picture. When a shaft begins to rub the bearing as a result of misalignment, a displacement probe can directly track the misalignment behavior. By the time the rub is severe enough to trigger a temperature alarm, the damage is already done.

Mounting location and instrumentation bracket design are both critical for quality data.

A complete range of sensors, adapters, cables, connectors, converters, and fittings are available for new installations, retrofits, or replacement of sensors during an overhaul.

- Thrust position.
- Relative radial shaft vibration.
- Absolute radial shaft vibration.
- Rotor vs. case differential expansion.
- Bearing case vibration.
- Case expansion, LVDT.
- Rotor bow (eccentricity).
- Valve position, LVDT.
- Key, phase, and speed measurements.

# Large Steam Turbine Typical Instrumentation

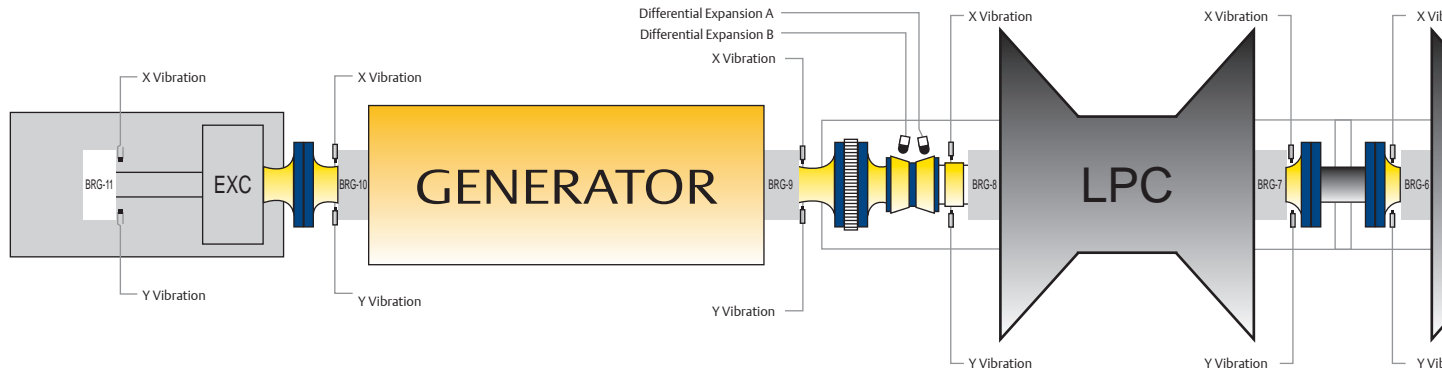

<p><b>Case Expansion Monitor</b></p> <ul style="list-style-type: none"> <li>▪ LVDTs mounted on both sides of the case measure expansion relative to the foundation on turbines greater than 250MW</li> <li>▪ It is important to monitor expansion on both sides for bending, which could cause rotor to stator contact</li> </ul>	<p><b>Rotor Speed</b></p> <ul style="list-style-type: none"> <li>▪ Speed monitoring – machine state information, trending and triggering acquisition</li> <li>▪ Zero speed – signals the operator to engage turning gear or alerts that turning gear has failed</li> <li>▪ Rotor acceleration – indicates load changes and coupling health</li> <li>▪ Reverse rotation</li> </ul>	<p><b>Phase</b></p> <ul style="list-style-type: none"> <li>▪ Vibration data is a vector with phase and magnitude</li> <li>▪ Changes in phase are as important to know as changes in amplitude</li> <li>▪ A change in phase is a key indicator of a possible cracked shaft</li> </ul>	<p><b>Process Input</b></p> <ul style="list-style-type: none"> <li>▪ Accepts 4-20 mA input and 0-10 volt input</li> <li>▪ Accepts RTDs and thermocouples directly</li> <li>▪ Inputs temperature, pressure, flow, and other process parameters</li> </ul> <p><b>Valve Position Monitor</b></p> <ul style="list-style-type: none"> <li>▪ Valve position can be used to track changes in load</li> </ul>	<p><b>Shaft Absolute</b></p> <ul style="list-style-type: none"> <li>▪ Shaft relative sensors and seismic sensors are used to mathematically produce a shaft absolute measurement</li> <li>▪ Absolute vibration measurements are recommended for turbines 250-650MW or greater</li> </ul> <p><b>Seismic</b></p> <ul style="list-style-type: none"> <li>▪ Electrodynamic seismic sensor input for bearing housing vibration measurements</li> </ul>
---	---	--	---	---

See instrument spec sheets for complete specifications about dynamic and static measurements.



ATEX Conformity for selected Products in accordance with EN 50 014 and EN 50 020, certified by the PTB

CSI 6500 Input: 12-24VDC 3.5A Max

CAN/CSA-C22.2 No. 61010-1-04: Safety Requirements for Electrical Equipment for Measurement, Control, and Laboratory Use, Part 1: General Requirements



Manufactured: Knoxville, TN  
UL Std. No. 61010-1 (2nd Edition): Safety Requirements for Electrical Equipment for Measurement, Control, and Laboratory Use, Part 1: General Requirements



IEC 61508:2010, Safety Integration Level (SIL) certification, Level 1

## It's the Network

Emerson's experts ensure proper design and execution for the CSI 6500 implementation in the plant. From onsite assessment, installation and project management to commissioning and analysis of predictive diagnostics, Emerson offers a team of world-class professionals and support network to ensure success including:

- Project Engineers design your system.
- Onsite Project Managers are your point of contact throughout the project.
- Remote analysis personnel experienced in diagnostics are available to offer a second opinion for increased confidence.
- Expert customer support is available 24/7 to answer the urgent questions that protection systems require.
- A network of world-wide support provides global coverage locally.

continued...

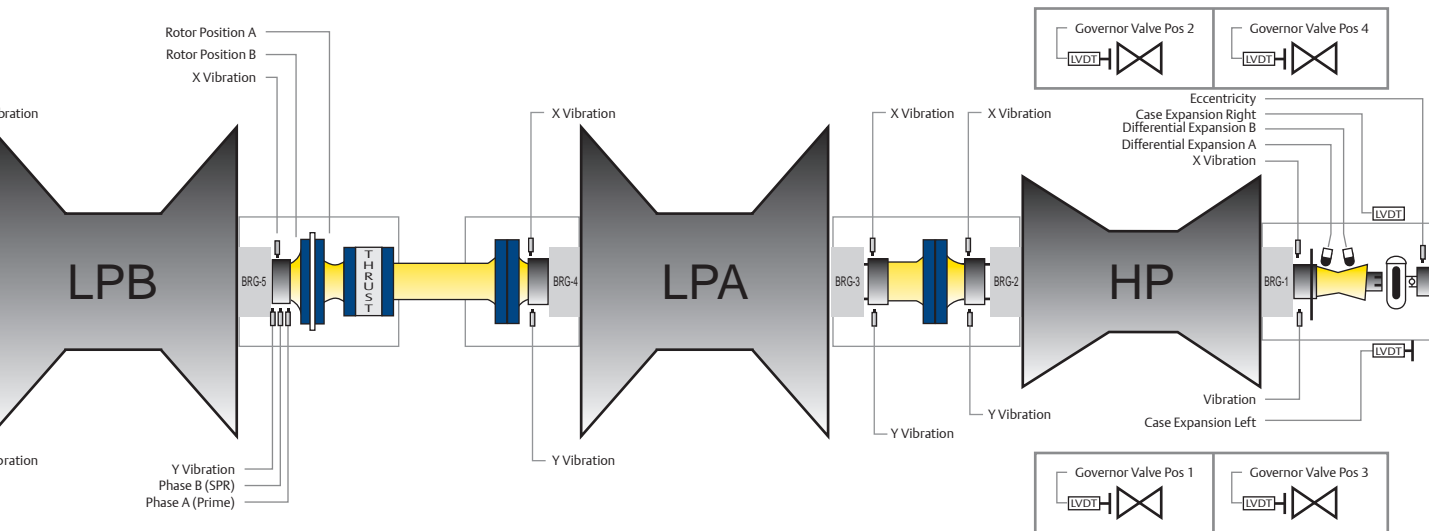

### Case Piezoelectric

- Used for rolling element bearings and gearboxes
- Also used for aero-derivative turbines where rolling element bearings are used
- Use PeakVue processing on rolling element bearings and gearboxes

### Dual-Thrust Position

- Thrust is an axial position near the thrust bearing and is one of the most critical measurements on a high-speed turbine
- At least two thrust sensors, for redundancy and for voting logic are recommended
- Thrust bearing deterioration, failure, or sudden changes in steam pressure can quickly move the rotor axially and cause collisions with rotor and stator

### Eccentricity

- A measure of rotor bow during startup, typically monitored from 0 to 600 rpm
- Rotor bow changes when thermal conditions change during startup, shutdown or even production state
- At least one displacement sensor in the high pressure section targets an eccentricity collar

### Differential Expansion

- Differential expansion is a radial rotor position measurement
- Differential expansion sensors are mounted on the case and measure the position of the rotor relative to the position of the case
- Recommended for turbines 250MW and greater
- Configurations may be ramp or complementary



*When machinery protection already exists, or is not needed, the CSI 6500 can be deployed for machinery health monitoring. When installed in the rear signal termination configuration, the CSI 6500 can accept up to 48 vibration inputs.*

## Proven Machinery Health

The performance of turbomachinery is critical, and you need real-time feedback, recorded machinery condition, and the ability to replay it for another view with deeper analysis. And you need it applied across the entire machine train, simultaneously. Meeting this demand is one of the greatest technology challenges of machinery health diagnostics. The answer is field-based predictive intelligence.

The CSI 6500 is uniquely designed with field-based intelligence that combines a protection system and a machinery health monitoring solution into one simple platform. With it, you have access to all of this information around the plant or around the world.

When a turbine starts up cold, the entire machine grows as it experiences extreme thermal conditions. The shaft grows rapidly. The case grows more slowly. Speed increases and tight clearances tighten. For your operator, seamless integration to the existing Ovation or DeltaV process automation system provides real-time machinery health feedback to run the process with confidence without adding a PC to the control room or learning a new software package. The operator is unaware that these lively updates are coming directly to their environment from underlying bus or Ethernet technology.

With Emerson's PlantWeb digital architecture, your plant is blanketed with predictive, digital intelligence that gives you back time – time to plan, time to make decisions, and time to stay focused on your business results.

## Real-Time Machinery Health for Maintenance

In a perfect world, machines would behave as expected and predictive maintenance applications like AMS Suite: Machinery Health Manager would automatically diagnose turbine malfunctions for you. But in the real world, sometimes you need powerful diagnostic tools to justify and support your machinery diagnosis.

The CSI 6500 is designed for real world challenges with field-based intelligence, continuous simultaneous data recording, live data viewing on all channels, and playback capability. You can playback the turbine shutdown, or startup, or even the bump in the night for your staff as you are explaining the results.

With the CSI 6500 transient analysis option, nothing is missed, everything is captured – no snapshots. Any question from management about turbomachinery health can be answered with continuous data and playback capability. With snapshots it's a gamble. For high speed, critical turbomachinery, Emerson brings the most powerful predictive diagnostics in the world to you.

## Power of Planning for Maintenance Analysis Parameters

In addition to protecting assets and real-time monitoring of turbomachinery, the CSI 6500 also takes a microscopic look at your turbine from a fault development and maintenance planning perspective. Up to 255 analysis parameters can be defined per CSI 6500 for diagnosing various malfunctions through waveform and spectrum dissection.

For each analysis parameter, LOLO, LO, HI and HIIH alerts and alarms can be set. Parameters such as multiples of 1x peak and phase, 3-8x energy common to looseness, sub synchronous bands for oil whirl, 0.5x for rubs, and even diagnosis around waveform shapes are continuously at work. For turbomachinery driving compressors or pumps through a gearbox, the CSI 6500 includes unique PeakVue technology for monitoring gearboxes and rolling element bearings.



AMS Suite provides powerful, real-time diagnostics in a graphical interface.

**Adaptive Monitoring**

An increase in vibration isn't necessarily a cause for alarm. It may be perfectly normal for vibration to increase when load increases – to a degree. The CSI 6500 has the unique ability to adjust monitoring strategy based on changing process conditions. This is possible through the field-based processing engine enabling event-based collection and adaptive monitoring.

The CSI 6500 will adapt its monitoring strategy based on different operating conditions, such as changing load or speed. Where you once had one trend window for a vibration parameter, you can now have two trend windows – one for 100% load, and one for 110% load – each with independent analysis and alerts.

**Field-Based Intelligence**

Field-based intelligence powers the advanced predictive features of the CSI 6500. Similar to a process automation architecture where the field-based controller performs monitoring and control in the field the CSI 6500 controls relays for machine shutdown protection, monitors for machinery health alarms, and streams transient data to users around the globe from the field-based processor. Intelligence in the field enables:

- Real-time updates of custom predictive parameters to process automation through bus technology.
- Event-based adaptive monitoring and alerts.
- 100+ hours of gapless turbomachinery continuous and simultaneous transient recording for all channels.
- Plant-wide scalable monitoring solutions.

**AMS Suite: Integrated Family of Software Tools**

AMS Suite is a family of best-in-class predictive diagnostics software applications that enables both plant-wide LAN and WAN asset management.

When applying AMS Suite to your critical equipment you gain:

- Predictive monitoring for both fixed assets and rotating assets.
- Powerful predictive analysis tools (plotting, trending, transient, spectral analysis, PeakVue technology, auto correlation, statistical analysis).
- Web-based case history viewer.
- Web-based asset prioritization and maintenance planning.
- Real-time machine performance.
- Graphical user interface.
- Process parameter import.



AMS Asset Graphics combines protection, prediction and performance details at the equipment layer through intuitive graphical information.

**AMS Suite: Asset Graphics**

AMS Asset Graphics provides a simple graphical view of process parameters, protection parameters, machinery health information, and equipment performance information. AMS Asset Graphics provides an operator view, with a machinery health focus while residing in the maintenance department.

AMS Asset Graphics includes:

- Graphical turbine / machine display with bar charts.
- Event / alarm log.
- Trending of vibration and process parameters.
- Notification (email, text message).
- Local cabinet graphical display.
- Touch screen support.

With the open architecture, you can integrate information to and from existing applications and systems such as existing:

- ModBus-compliant protection systems.
- ModBus or OPC-compliant process control system.
- OPC or SQL-compatible historians.

**AMS Suite: Machinery Health Manager**

After AMS Asset Graphics identifies changes and a potential machinery malfunction, AMS Machinery Manager provides an accurate assessment and comprehensive view of each monitored machine in your facility.

AMS Machinery Manager integrates data from multiple technologies into a single database for analysis and reporting.

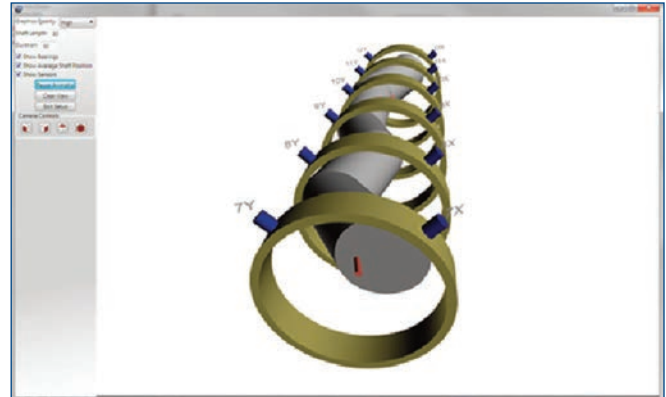

Use the Live 3D Shaft Animation to see the motion of the shaft around the average bearing shaft centerline. All aspects of the display, including angle of view and playback speed, are controlled by the user.

Specific for turbomachinery, AMS Machinery Manager includes:

- Transient real-time live sessions.
- 100+ hours of recorded turbine data – start-up, shutdown, and production state monitoring.
- Turbine replay of any recorded session.
- 3D machine analysis with ME'Scope.
- Local cabinet graphical display.
- Touch screen support.
- 3D shaft animation for in-depth analysis.
- Web-based Machine History Viewer.
- Collaboration tool for knowledge exchange.
- Waveform audio replay.
- Configurable online watch updates.
- Full spectrum analysis, including shaft rub detection.
- Shaft centerline resting position detection.

**Transient Real-Time Live Sessions**

Field-based intelligence connects you directly to the machine. This unique architecture enables the AMS Suite to provide powerful predictive tools not possible through PC based data acquisition systems. Overall vibration trends, orbits, shaft centerline, Bode/Nyquist, cascade, waveform and spectrum can all be viewed live, for all bearings desired, simultaneously.



# scenario

## When the Turbine Trips

You are comfortably home for the evening when the phone rings and you learn the turbine just tripped. The decision to restart the equipment is yours. Although you feel the pressure, you are confident because you have two powerful tools to rely on – continuous data recording to replay and analyze the event and a live mode to provide feedback during startup. Hours of live recorded data before, during and after the turbine trip is waiting for you.

As you drive to the site, you review the facts:

1. You have the proper setup to capture the data surrounding the event. You are assured the right data and the anomalous event is captured.
2. Your online machinery monitoring system provides real-time continuous waveform recording to ensure events will not be missed. With AMS Suite, a running history is always available. The field-based processor is a continuous data recorder and records and buffers up to 100+ hours of continuous time waveforms simultaneously at all bearings. Auto-archiving of data is also included so that small, one-hour snapshots can be saved to a network server.

3. Your live turbine view will support real-time decisions during startup.

When you arrive onsite, you learn it was a manual, operator-initiated trip. The operator had real-time vibration data from the CSI 6500 and real-time oil temperature and pressure diagnostics from the process automation system that indicated the turbine should be brought down. In fact, the maintenance team had already found the plugged oil line to the bearing. Now the only questions are “How much damage was done? And can we restart?” Thankful for multi-channel, continuous data recording, you look at the quick views and extract the region of interest for more analysis.

You review the data, compare with baseline, and confirm the vibration is isolated to one bearing. The shaft centerline plots tell you the bearing clearance was not exceeded. After fixing the oil flow issue, you restart the turbine. You watch the startup with AMS Suite for a real-time “inside the turbine” view.

The integrated online machinery monitoring solution of prediction, protection, performance monitoring, and PlantWeb allowed you to easily access critical information to make a confident decision.

## 100+ Hour - Turbine Data Recorder

A 100+ hour buffer of continuous time waveforms are simultaneously recorded for all sensors, all bearings, across the entire machine train. If an interesting event occurs, a manual or auto archive automatically and permanently saves a continuous slice of the running window. This slice can be analyzed, stored, or recalled to overlay on current data.

## Turbine Replay

Replay the data so you can watch the anomaly, the startup or the shutdown again. During replay, change the filter on your orbit or change the 3D perspective of the cascade plot to fine tune your analysis criteria to highlight the issue to your staff.

### 3D Machine Analysis with ME'Scope

ME'Scope uses 3D graphical animation to visually show how your machine or structure is moving. See overall movement, and movement of one part relative to another. Right-click a transient waveform through built-in menus to automatically send data to ME'Scope to see the animations in slow motion. You can identify malfunctions in your machines that could not be seen through any other analysis.

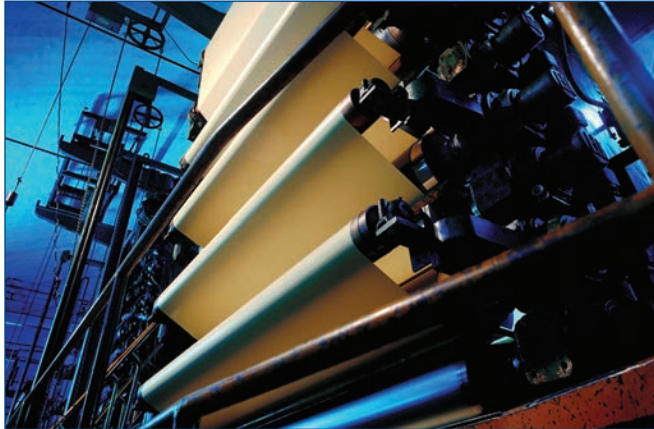

The CSI 6500 provides solutions to address key issues such as asset malfunction, barring, or chatter in the paper mills and roll process industries.

### Roll Process Industry Solutions

In paper mills and the metals industry, a single bearing or asset malfunction can result in a “wreck”. Barring or chatter can cause variation in caliper or basis weight, which means poor product quality.

And simple process changes like misaligning a stretch roll without feedback to the process automation system can destroy bearings and result in downtime.

Asset malfunctions monitoring, product quality monitoring, and feedback to process automation are the components of a complete solution for the roll process industries.

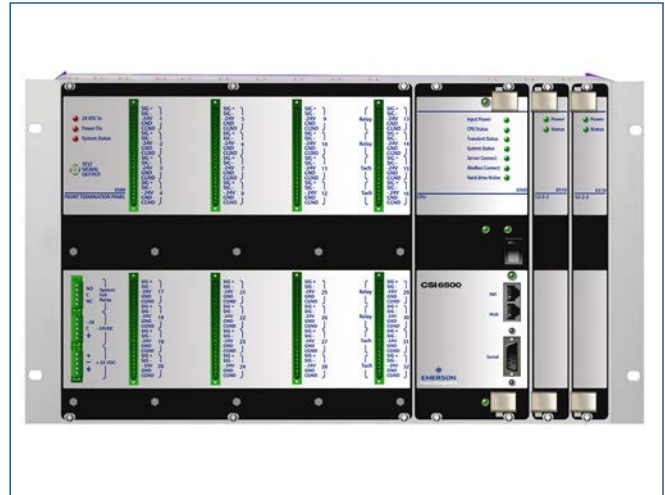

The front termination panel option is specifically designed for wall-mount enclosures in the roll process and metals industries.

The CSI 6500 includes these predictive monitoring capabilities to address these issues:

- PeakVue.
- Order tracking.
- Transient analysis.
- Adaptive monitoring.
- Time-synchronous averaging.
- Integration with CSI 2140 Machinery Health Analyzer routes.
- Over 24 definable analysis parameters per sensor.
- Integration with AMS Machinery Manager.

The CSI 6500 prediction solution is the perfect fit for continuous roll process applications. The front termination panel option is designed specifically for wall-mount enclosures so the field-based monitor can be installed near the machines. This saves on cable costs and installation costs.

#### PeakVue

PeakVue is the industry standard for early identification of rolling element bearing and gearbox problems. The same technology used in the CSI 2140 is also available in the online monitoring solution. Undetected dryer and inner race cracks are a thing of the past when you catch them real-time, instead of on a monthly route.



The CSI 6500 can be configured for protection only and provided in a 3U rack when space is a concern.

**Order Tracking**

Order tracking is a unique tool for winders and machines constantly changing in RPM where spectral data would otherwise be smeared and useless. View critical data with clarity.

**Transient Analysis**

Transient analysis, developed for turbines, allows for monitoring of many channels simultaneously. For press sections and calendar stacks, transient analysis is the only way to see rapidly changing information simultaneously.

**Adaptive Monitoring**

Adaptive Monitoring is made possible through intelligent monitoring in the field. Vibration data is collected and processed in the field much like the field-based controller of a process automation system. This allows advanced and flexible analysis and calculations in the field while reducing data sent back to the user.

**Time-Synchronous Averaging**

In a press nip, multiple rolls are in contact, which means vibration from one roll will be transferred to all the rolls in nip. With time synchronous averaging, vibration sensors, and a tachometer on each roll, vibration can be pinpointed to the specific roll, even when it is in nip.

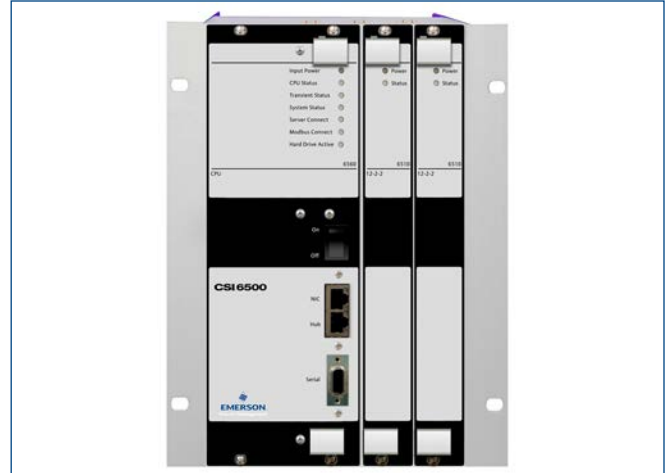

Prediction monitoring capabilities can be configured into a small rack to give you powerful capabilities while requiring minimal space.

Portable vibration and online vibration data can be viewed in the same database simultaneously and dragged onto a plot to overlay. Integrated products means less learning and more results.

**Over 24 Analysis Parameters per Sensor**

Over 24 analysis parameters for one sensor means flexibility in automatic diagnostics. Set up multiple parameter windows, and analysis characteristics to get the alerts you want without bothering with routine analysis. The analysis is still there when you need it.

In paper and metals, three aspects of monitoring are crucial:

- Instant overall vibration feedback for rapidly changing machine malfunctions.
- Product quality to operators.
- Detailed machine health assessment over time to help manage maintenance activities.

The CSI 6500 delivers the fastest and most powerful predictive capabilities on the market.

## Emerson's Power and Water Industry Center

Designed specifically for the power generation and water/wastewater treatment industries, the Ovation process automation system offers integrated asset management through the CSI 6500 and seamless incorporation of intelligent field devices for optimum control of critical processes.

### The PlantWeb Advantage

Get off to a strong start with your technology investment. Use Emerson's Asset Optimization Services to ensure you are effectively employing the CSI 6500 and your online machinery monitoring solution. Emerson experts can help you use diagnostics from your critical machinery to full advantage.

Our experts will: INSTALL the technology and complete your initial set up; then IMPLEMENT the technology by prioritizing your mechanical assets and optimizing your alert parameters to integrate the technology in your work processes to increase your maintenance and operational efficiency and ensure impact to your bottom line.

### Ordering Information

Please see individual Monitoring Module spec sheets for specific functionality and part numbers.

**Emerson Process Management  
Reliability Solutions**  
835 Innovation Drive  
Knoxville, TN 37932  
T (865)675-2400  
[www.emersonprocess.com/csi](http://www.emersonprocess.com/csi)

©2014–2016, Emerson Process Management.

The contents of this publication are presented for informational purposes only, and while every effort has been made to ensure their accuracy, they are not to be construed as warranties or guarantees, express or implied, regarding the products or services described herein or their use or applicability. All sales are governed by our terms and conditions, which are available on request. We reserve the right to modify or improve the designs or specifications of our products at any time without notice.

All rights reserved. AMS, PlantWeb, PeakVue, Ovation, DeltaV, and Machinery Health are marks of one of the Emerson Process Management group of companies. The Emerson logo is a trademark and service mark of Emerson Electric Co. All other marks are the property of their respective owners.

MHM\_PDS\_CSI6500MacHealthMon\_0916