

# DH Series

## Regulators - Pressure Reducing

DDHXX1910X012

### Specifications

For other materials or modifications, please consult TESCOM.

#### OPERATING PARAMETERS

Pressure rating per criteria of ANSI/ASME B31.3

**Maximum Inlet Pressure**

500 psig / 34.5 bar

**Outlet Pressure Ranges**

0-20, 0-50, 0-100, 0-150, 0-250 psig  
0-1.4, 0-3.4, 0-6.9, 0-10.3, 0-17.2 bar

**Design Proof Pressure**

150% of rated inlet

**Leakage**

Bubble-tight

**Ambient Operating Temperature**

-4°F to 165°F / -20°C to 74°C

**Flow Capacity**

$C_v = 5.0$

#### MEDIA CONTACT MATERIALS

**Body, Back-cap**

316 Stainless Steel or Brass

**Bonnet**

303 Stainless Steel or Brass

**Diaphragm**

Ethylene Propylene (E.P.) or Nylon Reinforced, Gylon® (PTFE)

**Seat**

**Main Valve:** Buna-N, E.P., Chemraz®, Viton®

**Vent:** CTFE, Vespel®

**O-Rings**

Buna-N, E.P., Chemraz®, Viton®

**Remaining Parts**

300 Series Stainless Steel, Nitronic 60

#### OTHER

**Cleaning**

CGA 4.1 and ASTM G93

**Weight**

**Stainless Steel:** 15 lbs / 6.8 kg

**Brass:** 16 lbs / 7.3 kg

Vespel® and Viton® are registered trademarks of E.I. du Pont de Nemours and Company.

Gylon® is a registered trademark of Garlock, Inc.

Chemraz® is a registered trademark of Greentweed.



DOME LOADED

SPRING LOADED

TESCOM DH-Series single-stage regulator provides a compact size with high flow capability from 5-200 SCFM / 142-5663 SLPM. The large diaphragm and balanced main valve design provide low droop (larger usable flow range) than competitive designs. Available in spring or dome loaded configurations.

### Applications

- Purging, blanketing, high flow inerting, heat treating, and shielding gases
- Performs well at very low pressure differentials such as dewar-supplied processes
- Multi-drop breathing air stations

### Features and Benefits

- Available in 316 Stainless Steel or Brass
- Accurately regulates pressure up to 250 psig / 17.2 bar for spring load, 300 psig / 20.7 bar for dome load and 500 psig / 34.5 bar for air load (optional)
- Five outlet pressure ranges
- Choice of spring load or dome load (air load is optional)
- Low droop
- Panel mounting is available
- Flanged end connections available

DH Series Regulator Drawings

SPRING LOAD  
(VENTING)

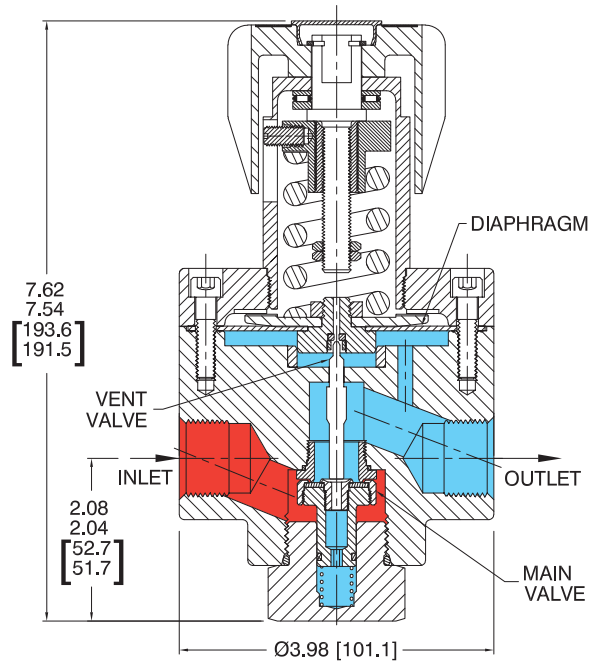

DOME LOAD  
(NON-VENTING SHOWN,  
VENTING AVAILABLE)

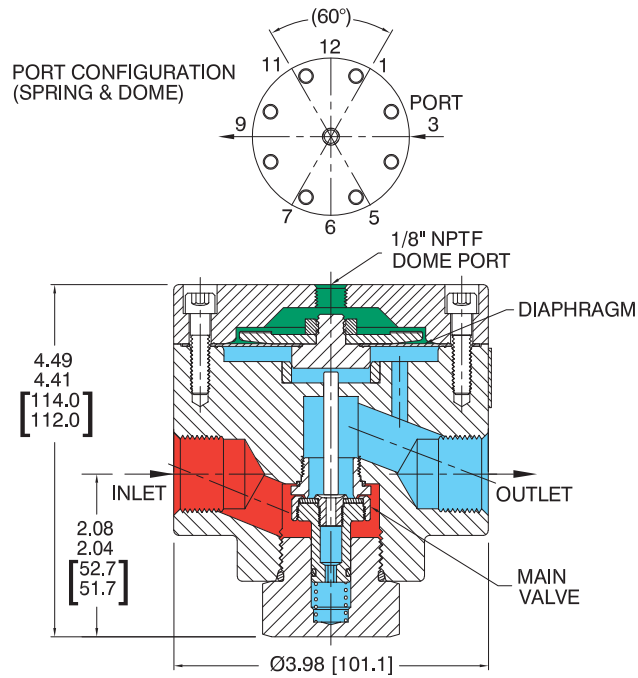

All dimensions are reference & nominal  
Metric [millimeter] equivalents are in brackets

### DH Series Regulator with Flanges Drawing

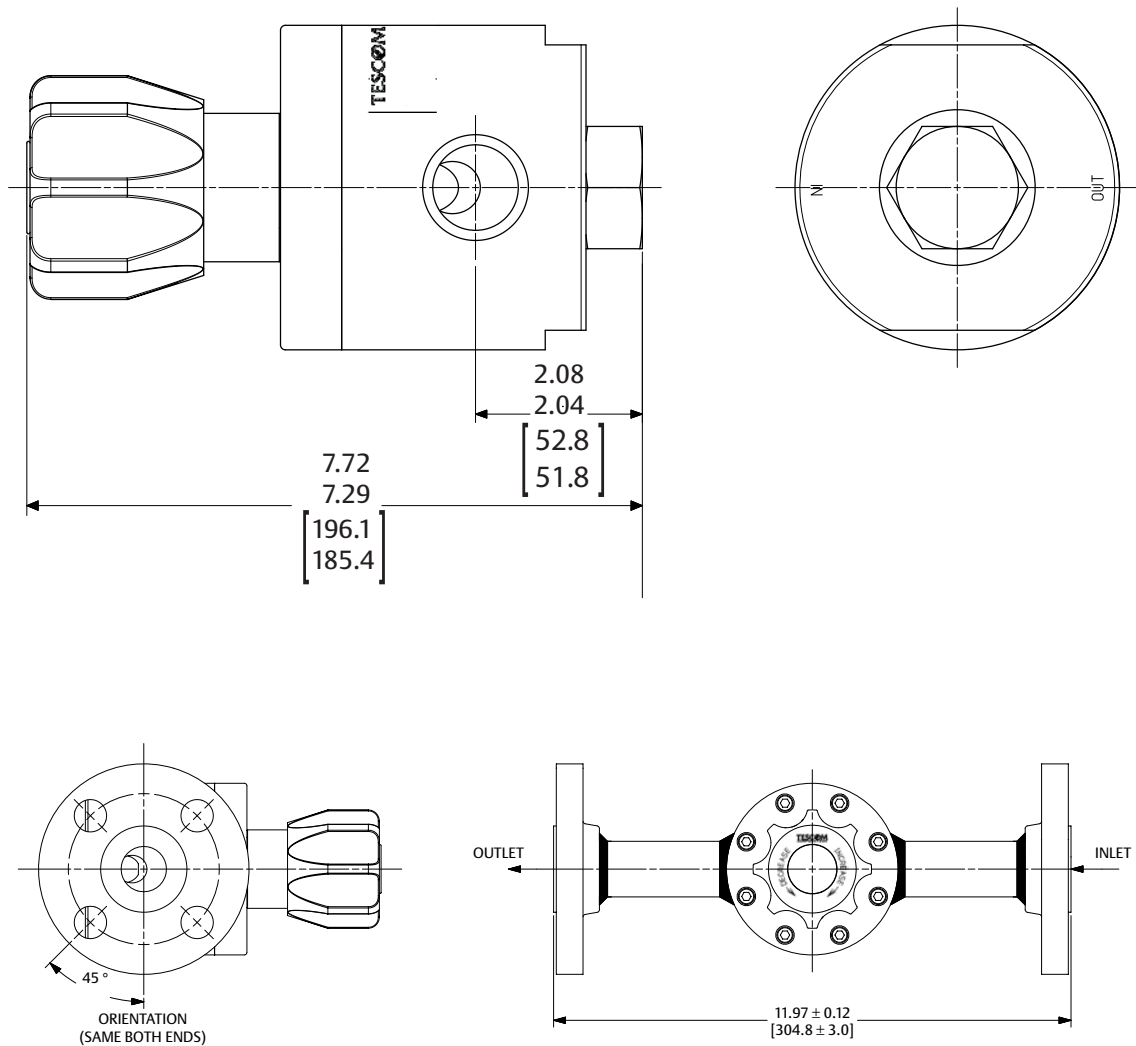

All dimensions are reference & nominal  
Metric [millimeter] equivalents are in brackets

### DH Series Regulator Flow Charts

For more information on how to read flow curves, please refer to the Flow Curves and Calculations document (debul2007x012) in the TESCOM catalog or on [www.tescom.com](http://www.tescom.com).

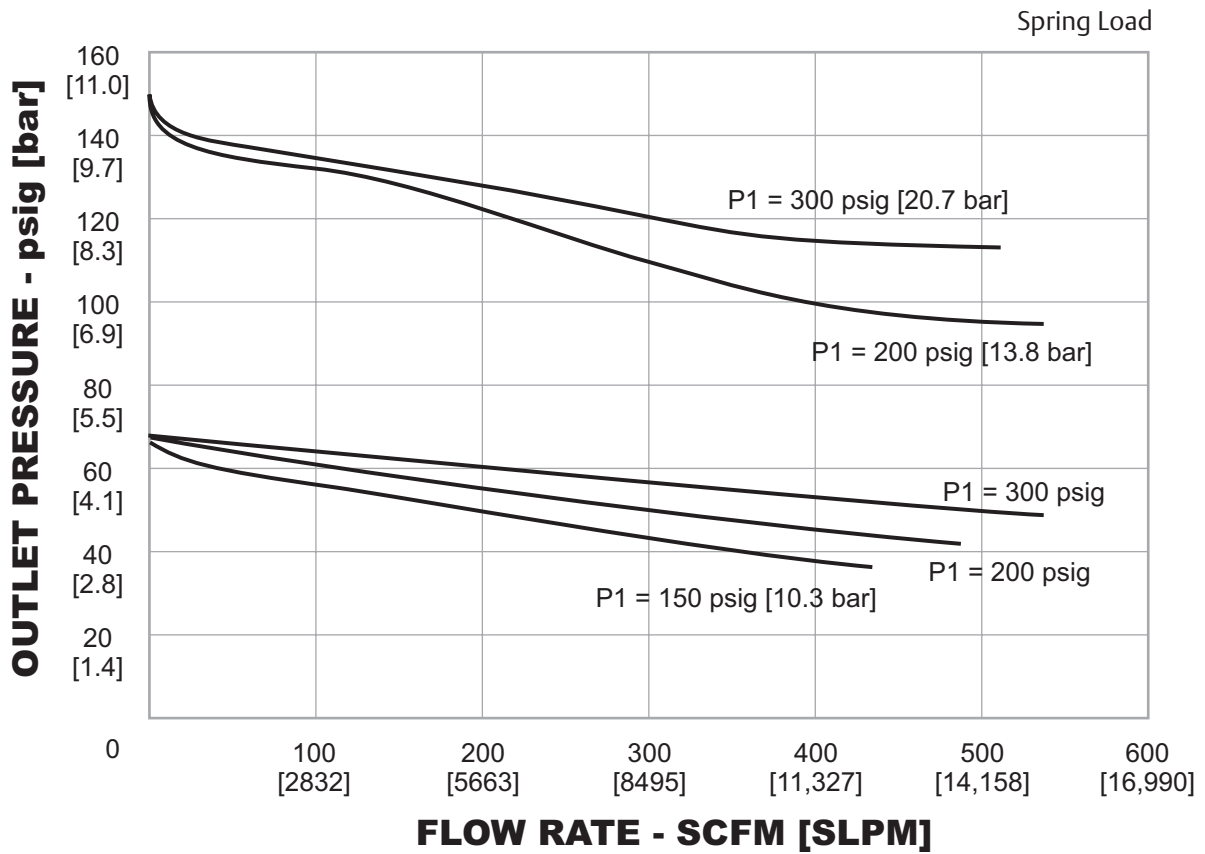

### DH Series Regulator Flow Charts



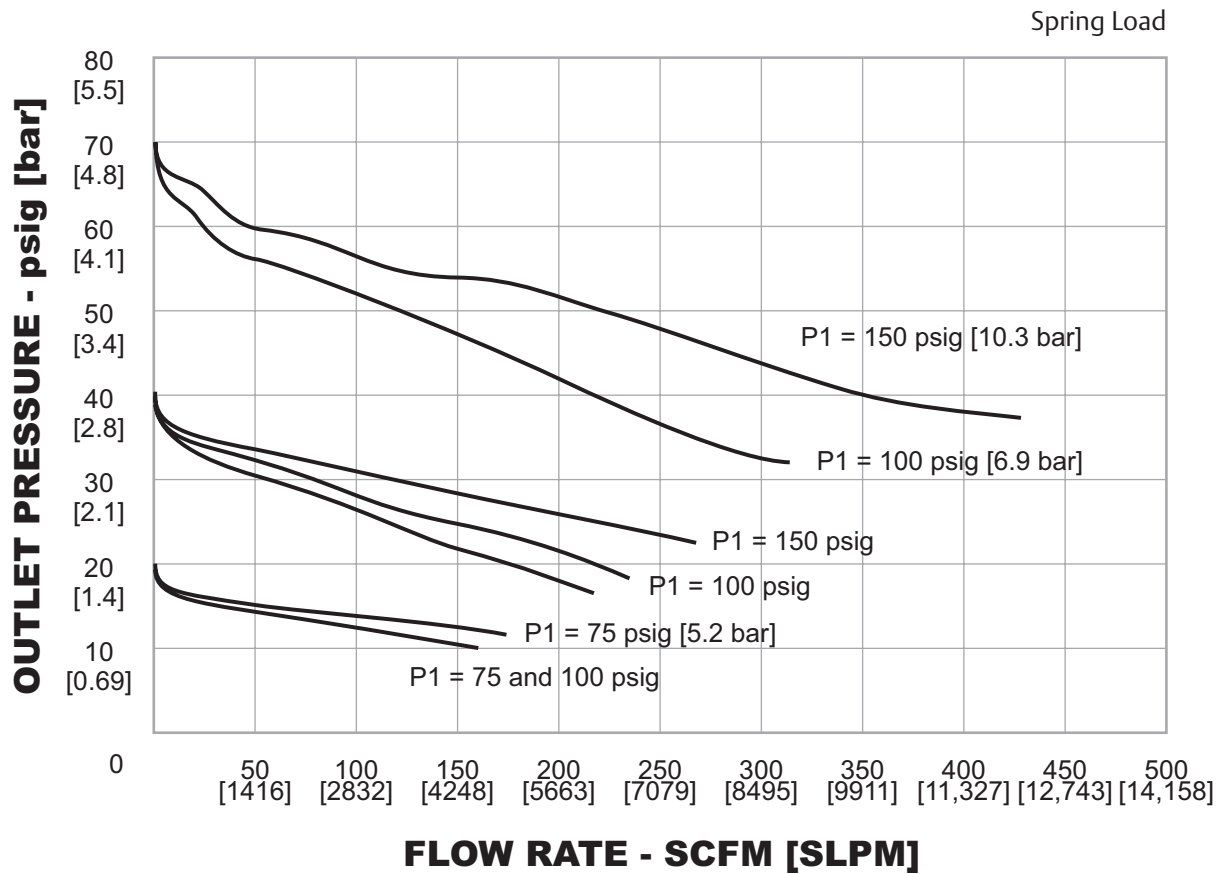

For more information on how to read flow curves, please refer to the Flow Curves and Calculations document (debul2007x012) in the TESCOM catalog or on [www.tescom.com](http://www.tescom.com).



## DH Series Regulator Part Number Selector



Repair Kits, Accessories & Modifications may be available for this product. Please contact TESCOM for more information.

Threaded End Connector Part Number Selection:

										INLET	OUTLET	GAUGE
										4	4	9
BASIC SERIES	LOAD TYPE	BODY, BONNET, BACK-CAP MATERIAL	OUTLET PRESSURE	O-RING AND VALVE SEAT MATERIAL	DIAPHRAGM MATERIAL	VENT SEAT MATERIAL	OPTIONAL ITEMS	PORTING CONFIGURATION	INLET, OUTLET, GAUGE PORTS			
DH	H – Spring Loaded, Handknob W – Spring Loaded, Wrench D – Dome Loaded (available with Gylon® diaphragm only)	1 – Brass 6 – 316 Stainless Steel	0 – 0-20 psig 0-1.4 bar 1 – 0-50 psig 0-3.4 bar 2 – 0-100 psig 0-6.9 bar 3 – 0-150 psig 0-10.3 bar 5 – 0-250 psig 0-17.2 bar D – 0-300 psig 0-20.7 bar (Dome Load only)	B – Buna-N O-Ring Buna-N 90 Seat E – E.P. O-Ring E.P. 80 Seat M – Chemraz® O-Ring, Chemraz® 75 Seat V – Viton®	E – E.P. Nylon Reinforced G – Gylon®	C – CTFE V – Vespel® P – Peek N – Non-Venting	C – CCL 9 – None	A – No gauge ports  B – 2 gauge ports at 60°  D – 1 outlet gauge at 90°  L – 2 gauge ports at 90° 	H – 1/2" NPTF* C <sub>v</sub> = 3.5 3 – 3/4" NPTF 4 – 1" NPTF 9 – None F – 1/4" NPTF (for gauge only) Y – 1/4" HPIC (for gauge only)			

\* Crossholes for 1/2" ports limits C<sub>v</sub> to 3.5

Flanged End Connector Part Number Selection:

DHW 6 0 B E V A 3 21 1											
BASIC SERIES	BODY, PIPE, FLANGE, BONNET BACK-CAP MATERIAL	OUTLET PRESSURE	O-RING AND VALVE SEAT MATERIAL		OPERATING TEMPERATURE	DIAPHRAGM MATERIAL	VENT SEAT MATERIAL	GAUGE PORT OPTIONS 1/4" NPT	FLANGE SIZE	FLANGE CLASS	FLANGE FACE
			O-RING	VALVE SEAT							
DHW	6 – 316 SST	0 – 0-20 psig 0-1.4 bar 1 – 0-50 psig 0-3.4 bar 2 – 0-100 psig 0-6.9 bar 3 – 0-150 psig 0-10.3 bar 5 – 0-250 psig 0-17.2 bar	B – Buna-N	Buna-N 90	-20 to 165°F /-29 to 74°C	E – E.P. Nylon Reinforced G – Gylon®	C – PCTFE* V – Vespel® P – Peek N – Non-Venting	A – R.H. Inlet No gauge ports  B – R.H. inlet, In & Out gauge ports at 60°  J – R.H. inlet 2 out gauge ports at 90° 	3 – 1"	11 – 150# 21 – 300# 41 – 600#	1 – RF

\* The maximum operating temperature for PCTFE vent seat material is 140°F / 60 °C



**WARNING!** Do not attempt to select, install, use or maintain this product until you have read and fully understood the TESCOM Safety, Installation and Operation Precautions.