

8

7

6

5

4

3

2

1

GENERAL NOTES (UNLESS OTHERWISE SPECIFIED)

REVISIONS						
REV	ECN	DESCRIPTION OF CHANGE	DRAWN	CHKD	APVD	DATE

D

D

Transmitter:

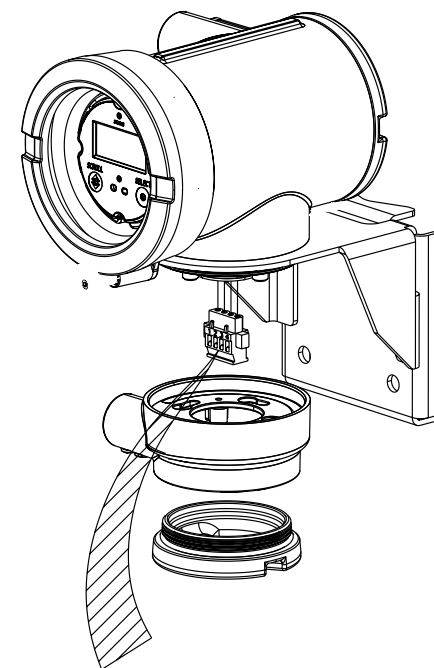

4-Wire Integrated Core Processor

C

C

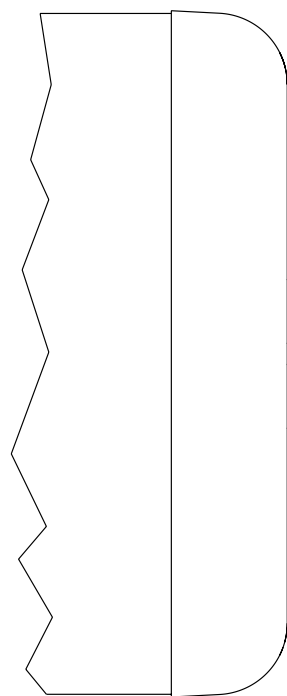

Low Flow Sensor

B

B

CABLE CONNECTOR ATTACHES TO SENSOR RECEPTACLE

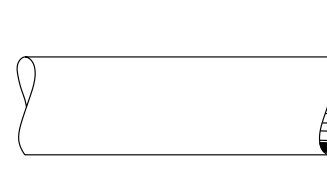
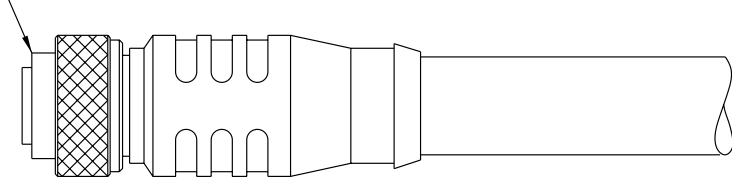

CLIP DRAIN WIRE

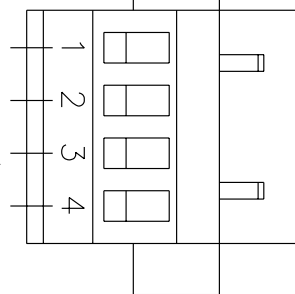

- (BRN) VDC+
- (BLK) VDC-
- (BLU) RS485A
- (WHT) RS485B



LFT FM

A

A

ITEM	DESCRIPTION	PART OR REF. NO.	MATL. OR MFR.	QTY.
 MICRO MOTION, INC. BOULDER, COLORADO				
 THIRD ANGLE PROJECTION		WIRING, LOW FLOW SENSOR TO LFT FM		
DRAWN	LLR	12/9/04	SIZE	DWG. NO.
CHKD.	JLA	12/9/04	D	EW-20002658
APVD.	JLA	12/9/04	SCALE NONE	DO NOT SCALE DRAWING SHEET 1 OF 1

COPYRIGHT 2004 MICRO MOTION, INC. ALL RIGHTS RESERVED

8

7

6

5

4

3

2

1