

# Replacement and Calibration of Mobrey SQUING 2 Electronic Cassettes



**NOTICE**

Refer to the Mobrey Squing 2 manual (document number IP2025) for more instructions. Manuals are available electronically on the Mobrey brand page at [www.emersonprocess.com](http://www.emersonprocess.com).

**WARNING****Failure to follow these installation guidelines could result in death or serious injury**

- The Mobrey Squing 2 is a *liquid level switch*. It must be installed, connected, commissioned, operated, and maintained by suitably qualified personnel only, observing any national and local requirements that may apply
- Ensure the wiring is suitable for the electrical current and the insulation is suitable for the voltage, temperature, and environment
- Use the equipment only as specified. Failure to do so may impair the protection provided by the equipment
- Any substitution of non-recognized parts may jeopardize safety and is under no circumstances allowed

**Explosions could result in death or serious injury**

- Installation of the Squing 2 in a hazardous environment must be in accordance with the appropriate local, national, and international standards, codes, and practices. Please review the Product Certifications section for any restrictions associated with a safe installation
- Verify that the operating atmosphere of the Squing 2 is consistent with the appropriate hazardous locations certifications

**External surface may be hot**

- Care must be taken to avoid possible burns

**Process leaks could result in death or serious injury**

- Install and tighten process connectors before applying pressure
- Do not attempt to loosen or remove process connectors while the Squing 2 is in service

**Electrical shock could cause death or serious injury**

- If the liquid level switch is installed in a high voltage environment and a fault condition or installation error occurs, high voltage may be present on leads and terminals
- Use extreme caution when making contact with the leads and terminals
- Make sure that power to the Squing 2 is off while making connections

## Replacement and calibration of electronic cassettes

When replacing a damaged or faulty cassette, it is necessary to calibrate the replacement cassette to the operating frequency of the fork assembly.

### Replacement sequence

If this replacement is taking place in a hazardous area, only qualified personnel should perform the replacement. All work in hazardous areas must be carried out in accordance to national and local codes of practice. Refer to the Mobrey Squiring 2 manual (IP2025) for product certifications and safety instructions for specific hazardous area installations.

Calibration of this device is complex and it may take several attempts before calibration is successful.

On Intrinsically Safe (I.S.) approved versions of the Squiring 2, it is recommended that replacement and calibration be performed in a non-hazardous (safe) area.

#### Note

- In I.S. applications, NAMUR cassettes can only be replaced with NAMUR cassettes, and 8/16 mA cassettes can only be replaced by 8/16 mA cassettes
- Non-I.S. cassettes can be interchanged with other non-I.S. cassettes, but the new label must be fitted and the original part number transferred to the new label (see “[Electrical installation](#)” on page 6 for connections to the electronic cassettes)
- Before starting the replacement and calibration procedure, ensure that any controlled process will not be adversely affected

### To replace the cassette, do the following:

1. Isolate and disconnect the power to the Squiring 2, and insulate the ends of the wires. On a Squiring 2 with a relay cassette, there may be more than one power source.
2. Remove the cover and disconnect the wires, noting any connections ([Figure 1](#)) and the exact mode switch position ([Figure 2](#)) on the cassette to be replaced.
3. Remove and retain the two fixing screws from the base of the cassette and unplug the cassette.
4. Plug in the replacement cassette, refit the screws, reconnect the wires, and set the mode switch to “Wet On” with a one second delay ([Figure 3](#)).
5. Reconnect the power to the Squiring 2.
6. Proceed to “[Calibration sequence](#)” on page 5.

**Figure 1. Top-down view of example cassette inside the housing**

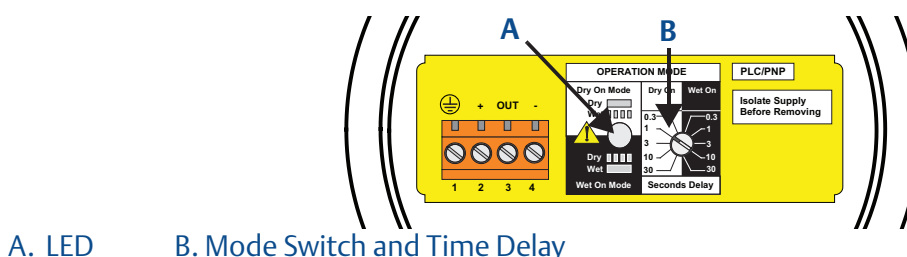

A. LED

B. Mode Switch and Time Delay

**Figure 2. Mode switch and setting on the existing cassette**

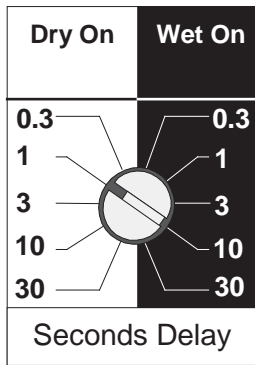

This is an example of how the existing cassette may look. Here, the switch is set to “Dry On” with a one second delay. Take note of the actual setting.

SETTING IS: \_\_\_\_\_

**Figure 3. Mode switch setting on the replacement cassette**

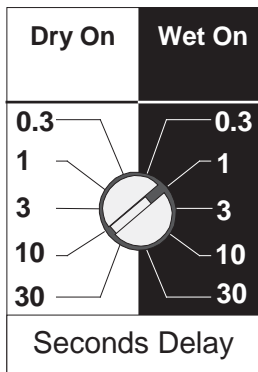

Set the mode switch of the new cassette to “Wet On” with a one second delay.

**Figure 4. Magnetic test point**

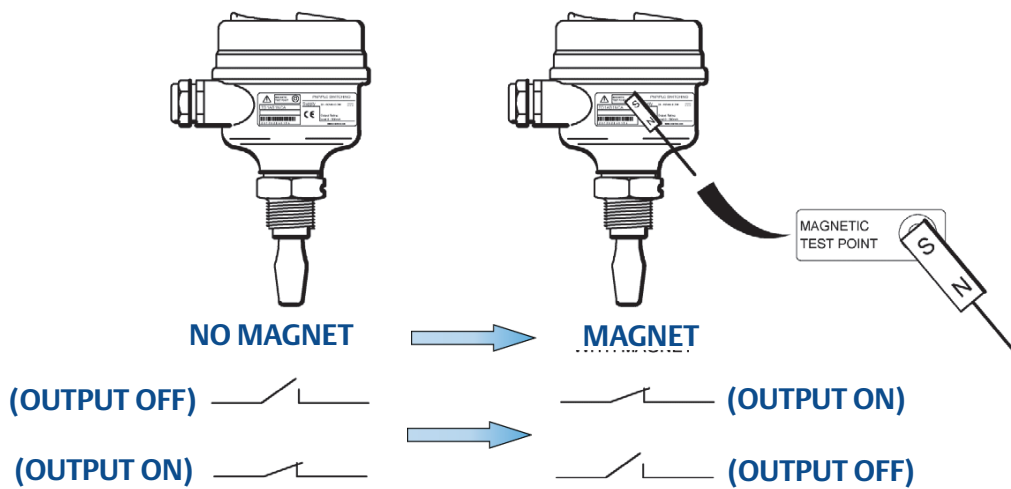



## Calibration sequence

This section describes what is required for calibration. Calibration sequence steps 3 to 13 are *time dependent* and must be carried out within the noted times. The purpose of the time dependency and switching sequence is to prevent an accidental calibration from occurring.

### To calibrate the cassette, do the following:

1. Ensure that the forks are dry, and the mode switch is set to “Wet On” with a one second time delay (Figure 3).
2. Check that the LED is flashing at a rate of one flash per second.  
If it is on continuously, proceed to step 8.
3. Apply magnet to the test-point (as shown on page 4).
4. After a one second delay, the LED will be lit continuously.
5. Within one second, rotate the mode switch two steps clockwise.
6. After a two second delay, the LED will go out.
7. Within three seconds, rotate the mode switch two steps counter-clockwise.  
Proceed to step 13.
8. Apply magnet to test point (as shown on page 4).
9. After a one second delay, the LED will flash at a rate of one flash per second.
10. Within one second, rotate the mode switch two steps clockwise.
11. After a two second delay, the LED will go out (stop flashing).
12. Within three seconds, rotate the mode switch two steps counter-clockwise.
13. After a two second delay, the LED should flash twice per second.
14. If the LED is flashing twice per second, the calibration has occurred correctly. Remove the magnet from the test-point. After a one second delay, the unit will return to normal operation. Proceed to step 17.
15. If the LED is flashing once per second or it is on continuously, the calibration has failed. Remove the magnet from the test-point, wait ten seconds, and then repeat from step 2.
16. If the LED stays off after the two second delay of step 13, the sensor is not working correctly. Check that the sensor forks are clean and dry. Also, verify there is nothing jamming or touching the sensor. If no fault is found with the sensor, the entire unit should be returned for repair.
17. Set the mode switch to the original setting noted in Figure 2 and wait five seconds.
18. Replace the cover and check that the system works.

# Electrical installation

-  Before use, check that suitable cable glands and blanking plugs are fitted and fully tightened.
-  Isolate supply before connecting the switch or removing the electronics.
-  The Protective Earth (PE) terminal must be connected to an external earthing system.

## Direct load switching electronics cassette (two-wire, red label)

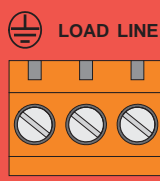

LOAD LINE

**OPERATION MODE**

Dry On Mode	Dry	
	Wet	
Wet On Mode	Dry	
	Wet	

**Direct Load Switching**

**WARNING** 

Isolate Supply Before Removing

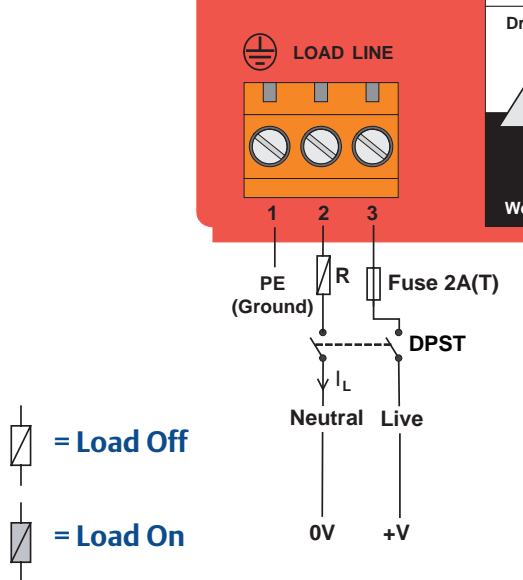





**R = External load (must be fitted)**

**U = 20 - 264 V ~ (ac) (50/60Hz)**  
 $I_{OFF} < 4 \text{ mA}$   
 $I_L = 20 - 500 \text{ mA}$   
 $I_{PK} = 5 \text{ A}, 40 \text{ ms (inrush)}$

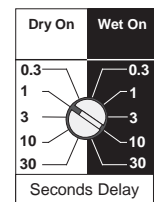
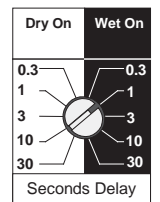
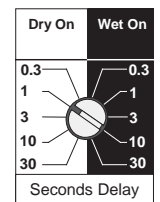
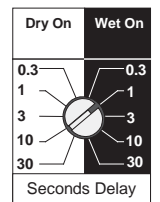
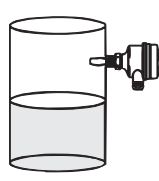
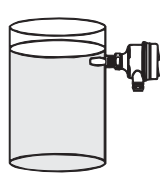
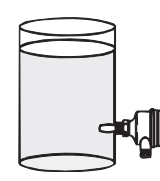
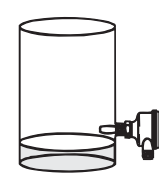
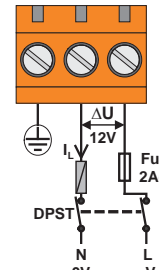
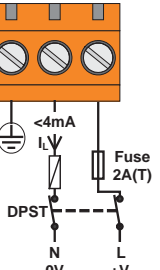
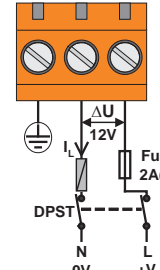
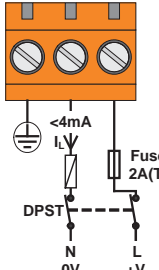
**U = 20 - 60 V --- (dc)**  
 $I_{OFF} < 4 \text{ mA}$   
 $I_L = 20 - 500 \text{ mA}$   
 $I_{PK} = 5 \text{ A}, 40 \text{ ms (inrush)}$

**Note: The values shown are nominal; see the Squing 2 manual IP2025 for complete data**

High level Dry = ON		Low level Wet = ON	
			
			
			
 <b>LED on continuously</b>	 <b>LED flashes each second</b>	 <b>LED on continuously</b>	 <b>LED flashes each second</b>

# PNP/PLC electronics cassette (three-wire, yellow label)

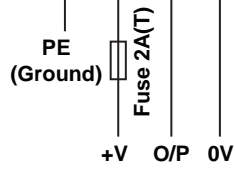
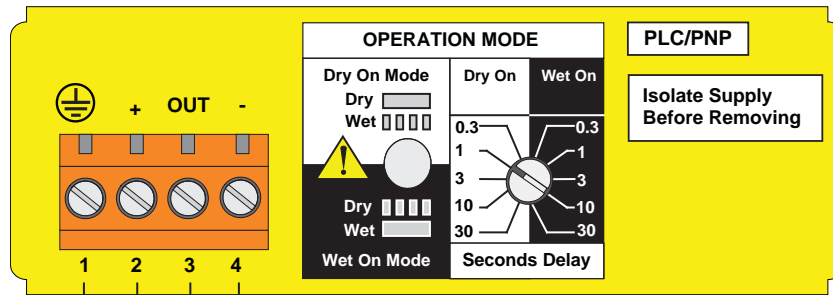

$U = 20 - 60 V^{dc}$   
 $I < 4 mA + I_L$

$I_L (MAX) = 0 - 500 mA$   
 $I_{PK} = 5 A, 40 ms (inrush)$   
 $U_{OUT(ON)} = U - 2.5 V$   
 $I_L(OFF) < 100 \mu A$

PLC/PNP

Isolate Supply Before Removing

**Note: The values shown are nominal; see the Squing 2 manual IP2025 for complete data**

	High level Dry = ON	Low level Wet = ON		
PLC (positive input)				
PNP dc				
	<b>LED on continuously</b>	<b>LED flashes each second</b>	<b>LED on continuously</b>	<b>LED flashes each second</b>

# Relay output electronics cassette (DPCO, green label)

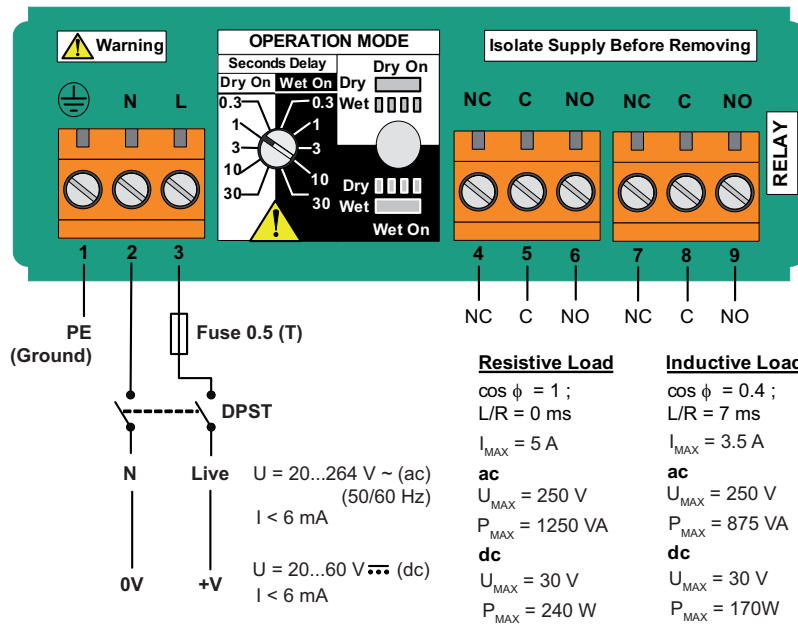

High level Dry = ON		Low level Wet = ON	
LED on continuously	LED flashes each second	LED on continuously	LED flashes each second



# NAMUR electronics cassette (light blue label)

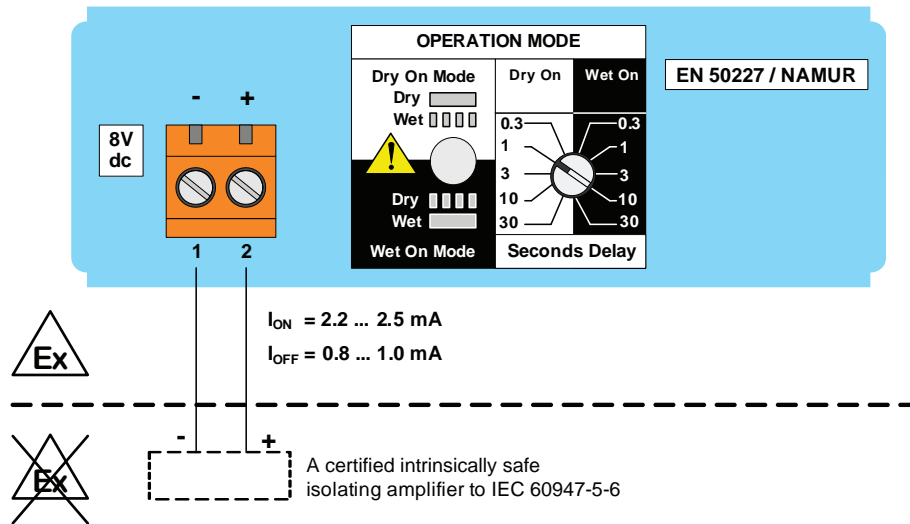

High level Dry = ON		Low level Wet = ON	
<b>LED on continuously</b>	<b>LED flashes each second</b>	<b>LED on continuously</b>	<b>LED flashes each second</b>

**Note**

- This cassette is suitable for Intrinsically Safe applications and requires a certified isolating barrier. See the Mobrey Squing 2 manual (IP2025) for Intrinsically Safe approvals
- This electronics cassette is also suitable for non-hazardous (safe) area applications. It can only be interchanged with the 8/16 mA cassette.
- Do not exceed 8 Vdc

### 8/16 mA electronics cassette (dark blue label)

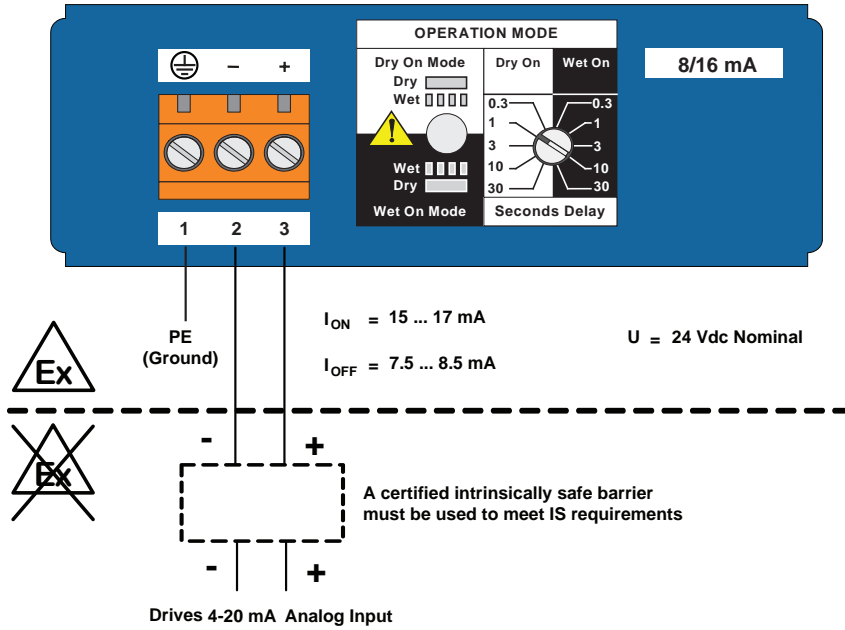

High level Dry = ON		Low level Wet = ON	
<b>LED on continuously</b>	<b>LED flashes each second</b>	<b>LED on continuously</b>	<b>LED flashes each second</b>

**Note**

- This cassette is suitable for Intrinsically Safe applications and requires a certified isolating barrier. See the Mobrey Squing 2 manual (IP2025) for Intrinsically Safe approvals
- This cassette is also suitable for non-hazardous (safe) area applications. It can only be interchanged with a NAMUR cassette

## Troubleshooting

If there is a malfunction, see [Table 1](#) for information on possible causes.







**Table 1. Troubleshooting chart**

Fault	Symptom/Indication	Action/Solution
Does not switch	No LED; no power	Check the power supply; (check load on direct load switching electronics model)
	LED flashing	See <a href="#">LED indication</a>
	Fork is damaged	Replace the Squing 2
	Thick encrustation on the fork	Clean the fork with care
	5 second delay when changing mode/delay	This is normal – wait 5 seconds
Incorrect switching	Dry = On, Wet = On set incorrectly	Set the correct mode on the electronics cassette
Faulty switching	Turbulence	Set a longer switching time delay
	Excessive electrical noise	Suppress the cause of the interference
	Cassette has been fitted from another Mobrey Squing 2	Fit the factory supplied cassette ( <a href="#">page 3</a> ) and then calibrate ( <a href="#">page 5</a> )

### LED indication

When the LED is red and flashing, it indicates the Squing 2 may be uncalibrated, successfully calibrated, has an electrical load problem, or has an internal PCB fault. See [Table 2](#) for further information.

**Table 2. LED flash rate**

LED Flash Rate		Switch Status
	Continuous	Output state is on
	1 every second	Output state is off
	1 every 2 seconds	Uncalibrated – see “ <a href="#">Calibration sequence</a> ” on <a href="#">page 5</a>
	1 every 4 seconds	Load fault; load current too high; load short circuit
	2 times every second	Indication of successful calibration
	3 times every second	Internal PCB fault (microprocessor, ROM, or RAM)
	Off	Problem (e.g. supply)

**Emerson Process Management  
Rosemount Measurement Ltd.**

158 Edinburgh Avenue  
Slough, Berks, SL1 4UE, UK  
T +44 (0)1753 756600  
F +44 (0)1753 823589  
[www.emersonprocess.com](http://www.emersonprocess.com)

**Emerson Process Management  
Rosemount Inc.**

8200 Market Boulevard  
Chanhassen, MN 55317, USA  
T (US) (800) 999-9307  
T (Intl) (952) 906-8888  
F (952) 906-8889

© 2012 Rosemount Measurement Ltd. All rights reserved.  
The Emerson logo is a trade mark and service mark of Emerson Electric Co.  
Mobrey is a registered trademark of Rosemount Measurement Ltd.  
All other marks are the property of their respective owners.  
We reserve the right to modify or improve the designs or specifications of product and services at any time without notice.

***mobrey***

  
**EMERSON**<sup>™</sup>  
Process Management