

M-series DeltaV™ Controller Interface for RS3™ I/O

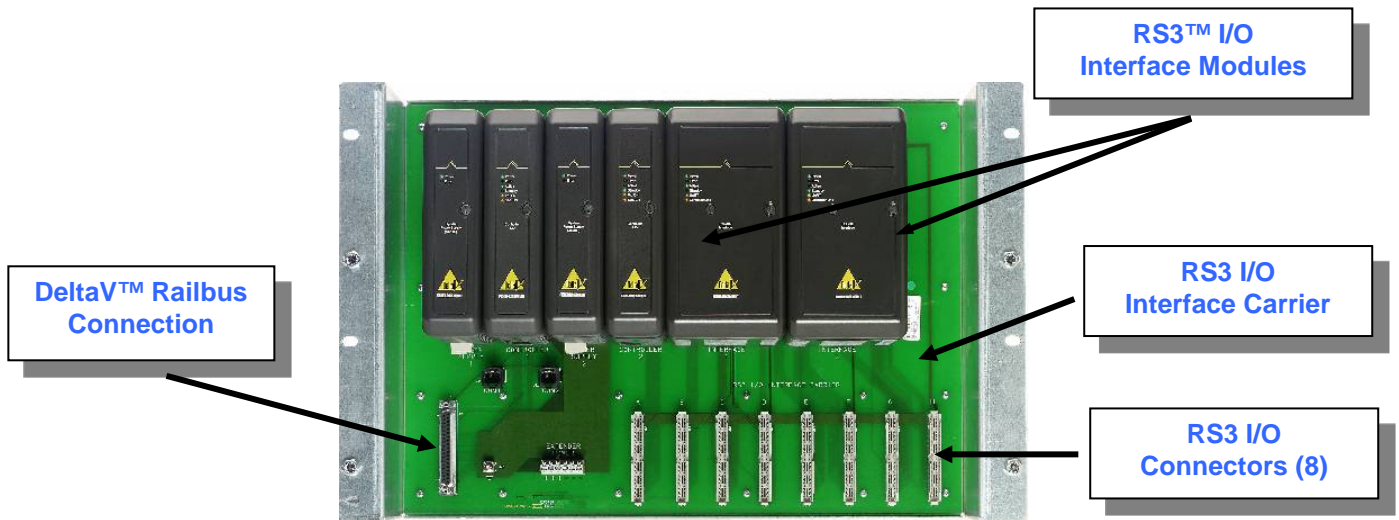

Upgrade your RS3™ ControlFiles with the M-series DeltaV™ Controller Interface for RS3 I/O and retain your installed RS3 I/O. (Showing redundant configuration).

- Allows you to use RS3™ I/O with DeltaV™ controllers
- Opens the door to new technology
- Reduces footprint

Introduction

This solution provides an upgrade to the RS3™ ControlFile with DeltaV™ controllers using the M-series DeltaV Controller Interface for RS3 I/O. This solution incorporates RS3 I/O to be integrated into the DeltaV architecture. The “heart” of the controller interface is a new DeltaV module that supports the serial I/O communication capacity of the RS3 ControlFile.

The DeltaV Controller Interface for RS3 I/O may be used with both RS3 FlexTerm and MultiPoint I/O subsystems. Additionally, RS3 I/O support is integrated into the DeltaV Explorer, Diagnostic, and Control Studio applications.



Benefits

Allows you to use RS3 I/O with DeltaV controllers. The DeltaV Controller Interface for RS3 I/O allows you to use your RS3 I/O and take advantage of the benefits of the DeltaV system. Upgrading to DeltaV controllers, while leveraging your existing investment in RS3 I/O and terminations and provides new capabilities at minimal cost.

Opens the door to new technology. Using the DeltaV Controller Interface for RS3 I/O opens the door to new technologies that are available only with the DeltaV system. Advanced Control applications like DeltaV Predict, DeltaV InSight and Neural Networks are now available to RS3 users.

Reduces footprint. The DeltaV system was designed to maximize efficient use of space. Similarly, the DeltaV Controller Interface for RS3 I/O provides a “footprint” reduction when compared to a ControlFile. This feature assures RS3 users that they may upgrade to DeltaV controllers and gain precious cabinet space.

Product Description

The DeltaV Controller Interface for RS3 I/O is comprised of the RS3 I/O Interface Module, the RS3 Interface Carrier and the integration of RS3 I/O into DeltaV software.

RS3 I/O Interface Module. The RS3 I/O Interface Module is a 2-wide module that provides serial communications between RS3 I/O and DeltaV controllers. The module supports serial communications with both RS3 FlexTerm and MultiPoint I/O subsystems.

The RS3 I/O Interface Module features 64 serial communication channels providing serial communications to the installed RS3 I/O. The RS3 I/O Interface Module, in effect, takes over the serial communication task of the ControlFile with the DeltaV controller managing the process.

The RS3 I/O Interface Module is designed with redundancy in mind. One-to-one redundancy is built in. As with RS3, should you have an application that requires optimum system availability, redundancy is an option.

DeltaV MQ or MX Controller. One DeltaV MQ controller (with DeltaV v12.3 or later firmware) or MX controller (with DeltaV v10.3) mounts on the carrier for a simplex installation, or two MQ or MX Controller mount for a redundant installation. The MQ controllers can handle up to 750 DSTs while MX controller can handle up to 1500 DSTs.

RS3 I/O Interface Carrier. The RS3 I/O Interface Carrier is a 19 inch rack mount device specifically designed to accommodate the RS3 I/O Interface. The carrier will accommodate these DeltaV modules:

- Two DeltaV MQ or MX Controller
- Two DeltaV System Power Supplies
- Two RS3 I/O Interface Modules
- The RS3 I/O Interface Carrier has eight (8) multi-channel connectors to provide connection to RS3 I/O.

Railbus Connection. Additionally, the RS3 I/O Interface Carrier features a 37 pin railbus connection that may be used to interface with additional M-Series DeltaV I/O modules. Standard 37 pin DeltaV interface cables are used to connect the RS3 I/O Interface Carrier to traditional DeltaV I/O horizontal carriers. This feature means that you can expand your system with DeltaV I/O to fully utilize your DeltaV controller investment. DeltaV Programmable Serial Cards may also be used to connect PLCs and other serial devices that were connected to the RS3 ControlFile through the PLC FlexTerm.

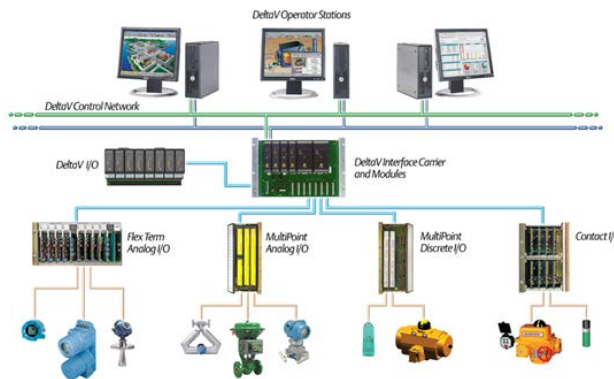

DeltaV™ Controller Interface for RS3™ I/O

Flexibility To Meet Your Needs

Complete integration. The DeltaV Controller Interface for RS3 I/O is fully supported by the DeltaV Explorer, Diagnostic, and Control Studio applications. You may configure and integrate RS3 I/O into control strategies as easily as DeltaV I/O.

The DeltaV Explorer fully supports the commissioning and configuration of RS3 I/O devices. Additionally, the DeltaV Explorer can enable and characterize individual I/O channels.

The DeltaV Diagnostic applications support RS3 I/O diagnostic messages. With the DeltaV Controller Interface for RS3 I/O there is no loss of I/O integrity monitoring.

HART® device support. Just like ControlFiles, the DeltaV Controller Interface for RS3 I/O supports HART® field devices. The DeltaV Controller Interface for RS3 I/O allows you to incorporate digital signals from HART devices into DeltaV control strategies. Support of HART devices is completely retained when upgrading your RS3 controllers to DeltaV.

Prepares you for the future. Device signal tags (DSTs) connected to RS3 I/O are treated the same as DeltaV I/O DSTs. This treatment pertains not only to configuration but also to DST licensing. When you replace RS3 I/O with DeltaV I/O in the future no additional licensing is required. You are assured that your investment when upgrading RS3 I/O is retained.

In summary, RS3 I/O subsystems may now be connected to DeltaV controllers. This solution provides a transition option that will:

- Preserve your investment in RS3 I/O
Add new technology, like Advanced Control, to your RS3 system.

Maximize your display engineering efficiency. Emerson offers services for generating your new DeltaV displays. Learn how RS3 configuration can be automatically converted or how new display and control designs can optimize effectiveness of your new DeltaV Controller Interface for RS3. For more information, see these data sheets:

Control Configuration Transition Services

Display Transition Services

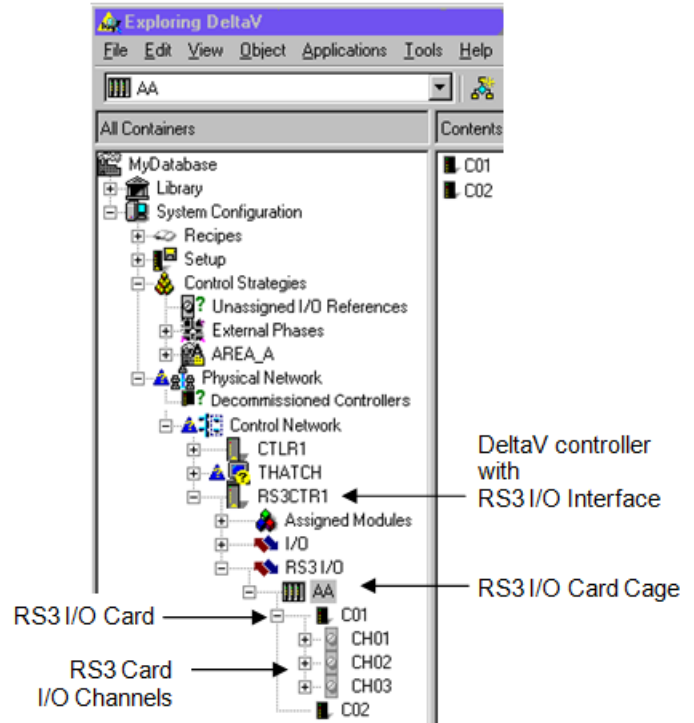

RS3™ I/O is integrated into DeltaV™ Explorer

Add an I/O card cage.

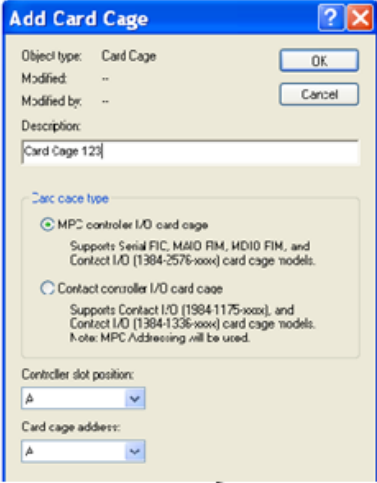

Select a card type.

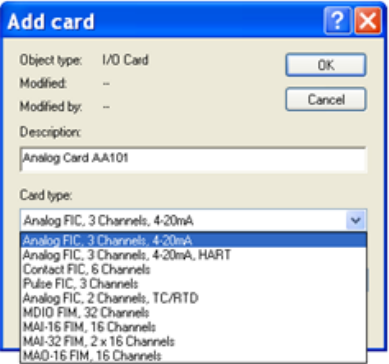

Modify card properties.

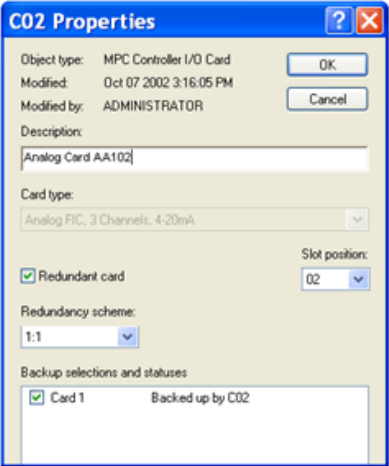

Modify channel properties.

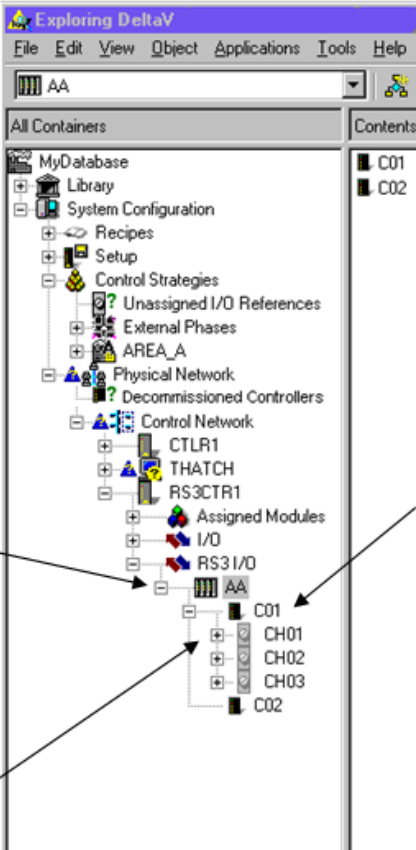
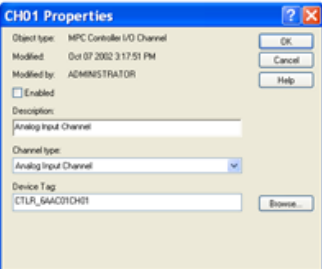

Dialog boxes for RS3™ I/O configuration

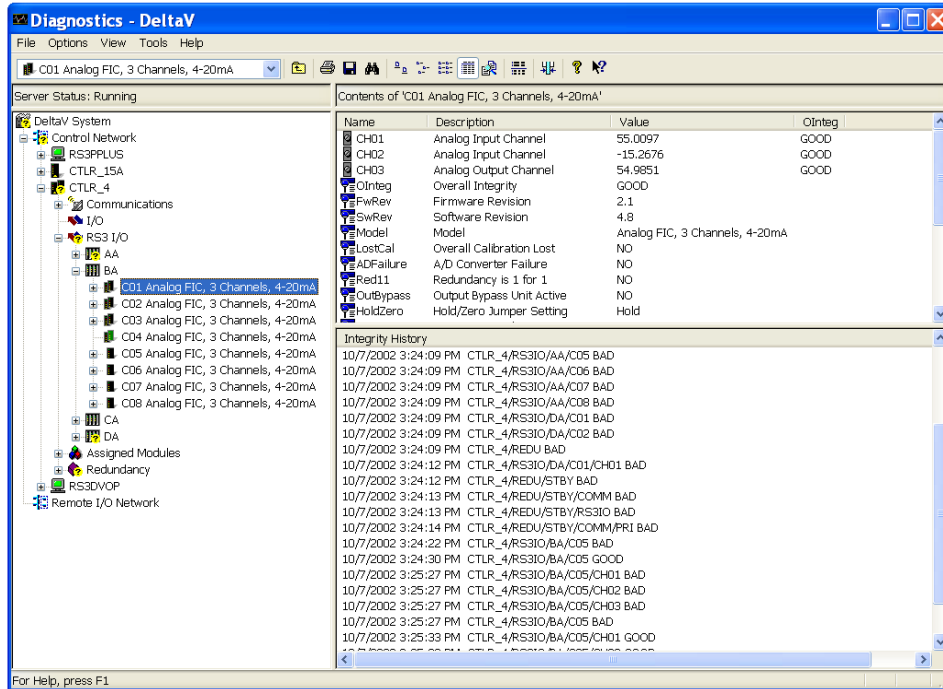

RS3™ I/O is integrated into DeltaV™ diagnostic application

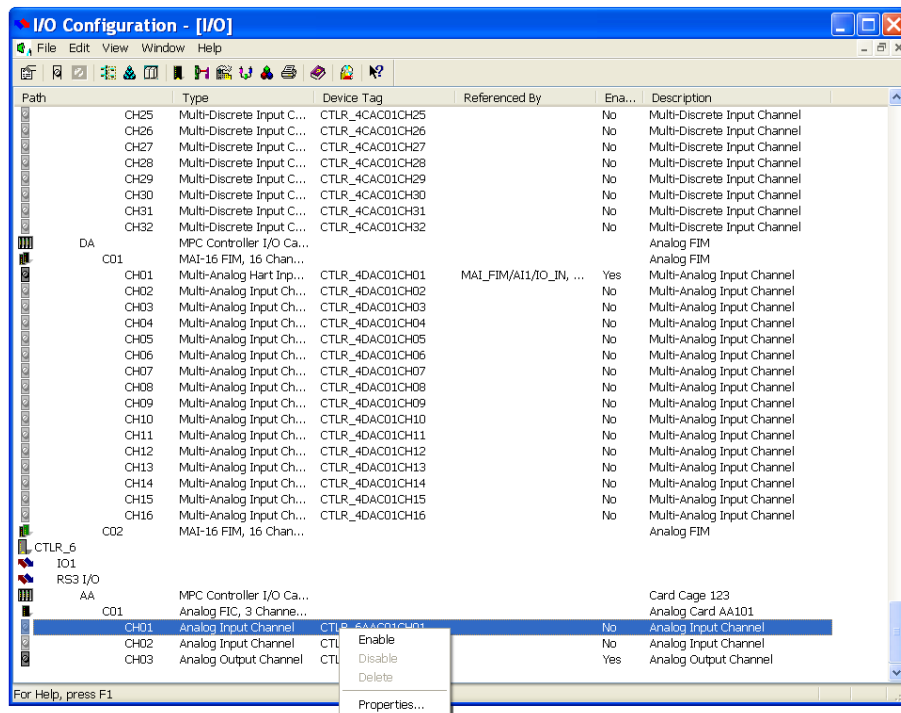

RS3™ I/O is supported by the DeltaV™ I/O configuration application

Specifications for the RS3™ I/O Interface Module	
RS3 Serial Interface	
Serial I/O Channels	64
Baud Rate	10.4 Kbaud
RS3 I/O Types Supported (Notes 1 and 2)	
Analog FIC “FlexTerm” I/O (MPC controller type only) <ul style="list-style-type: none"> • Analog Cards (2 In / 1Out) • Pulse Cards • Temperature Cards 	MultiPoint Analog I/O <ul style="list-style-type: none"> • 16 Point Input • 32 Point Input • 16 Point Output
Contact FIC “FlexTerm” I/O (MPC, CC controller types)	MultiPoint Discrete I/O <ul style="list-style-type: none"> • 32 point Input/Output
Power requirement (VE5008 DeltaV system power supply)	+12.0 VDC at 1.1 A
Maximum current	1.4A
Fuse protection	3.0 A, non-replaceable fuses
Power dissipation	13.2 W typical, 17 W maximum
Environmental specifications	
Operating temperature	0 to 60 °C (32 to 140 °F)
Storage temperature	-40 to 85 ° C (-40 to 185°F)
Relative humidity	5 to 95%, non-condensing
Airborne contaminants	ISA-S71.04-1985 Airborne Contaminants Class G3 coating
Shock (normal operating conditions)	10 g ½-sine wave for 11 ms
Vibration (operative limit)	1 mm peak-to-peak from 5 Hz to 16 Hz, 0.5 g from 16 Hz to 150 Hz
I/O Module LED Indicators	ON Status Indicates
Green – Power	DC power is applied
Red – Error	An error condition
Green – Active	I/O Driver is in the active state
Green – Standby	I/O Driver is in the standby state
Yellow, flashing – UART	Communication error with at least UART
Yellow, flashing – Controller Link	Communication link between the Controller and I/O
All except Power flashing, alternating even and odd	Firmware upgrade in progress

NOTES:

1. RS3 Single Strategy Controller (SSC) and Multi-Loop Controller (MLC) Analog I/O FIC are not supported.
2. DORIC MUX (FEM) analog inputs are not supported

Specifications for the RS3™ I/O Interface Carrier		
Capacity	Six Devices (Controller, Interface Module, and Power Supply)	
Non-Redundant Configuration	(1) MQ or MX Controller (1) System Power Supply (1) RS3 I/O Interface Module	
Redundant Configuration	(2) MQ or MX Controllers (2) System Power Supplies (2) RS3 I/O Interface Modules	
Dimensions	Centimeters	Inches
Height	31.1	12.75
Width	48.3	19.0
Depth	8.9	3.5
	Current Rating	
Backplane	16 A max (supplied to I/O cards)	

Common Environmental Specifications for the RS3™ I/O Interface Carrier	
Storage Temperature	-40 to 85 °C (-40 to 185 °F)
Operating Temperature	0 to 60 °C (32 to 140 °F)
Relative humidity	5 to 95% , non-condensing
Airborne contaminants	ISA-S71.04-1985 Airborne Contaminants Class G coating
Protection rating	IP 20, NEMA 12
Hazardous area/location	CENELEC Zone 2 IIC T4 hazardous area or Class Groups A, B, C, D T4 hazardous locations
Shock	10 g ½-sine wave for 11 ms
Vibration	1 mm peak-to-peak from 5 to 16 Hz; 0.5 g from 16 to 150 Hz

Ordering Information

DeltaV Controller Interface for RS3 I/O consists of six types of components: a DeltaVMQ and MX controller, a DeltaV power supply, an RS3 I/O carrier, and an RS3 I/O interface module. Order entry numbers given in the following table include all components required for a solution. For non redundant interface solutions, model numbers include one of each component and model numbers for redundant solutions include one RS3 I/O Carrier and two each of the other components (controller, power supply, and I/O interface).

Description	Model Number
DeltaV Controller Interface for RS3 I/O – Non Redundant	VE3022C4R1 (Using MQ Controller)
DeltaV Controller Interface for RS3 I/O – Redundant	VE3022C4R2 (Using MQ Controller)
DeltaV Controller Interface for RS3 I/O – Non Redundant	VE3022C3R1 (Using MX controller)
DeltaV Controller Interface for RS3 I/O – Redundant	VE3022C3R2 (Using MX controllers)

Order entry numbers and requirements for individual components of the DeltaV Controller Interface for RS3 I/O solution are shown in the following table.

Description	Model Number
DeltaV MQ or MX Controller	VE3008 or VE3007
RS3 I/O Carrier	VE4057 (KJ2102X1-CA1)
RS3 I/O Interface	VE4019R11 (KJ2102X1-BA1)
DeltaV System Power Supply	VE5008 (Final assembly P/N 12P2186) or VE5009 (Final assembly P/N 12P3935) is required for use with 12P0238X012 RS3 system power supply. For other power supply combinations, match output voltage range of source to input voltage range of the DeltaV power supply.

Prerequisites

- The MQ Controllers requires DeltaV software release v12.3 or later
- The MQ Controller can be used on a v11.3.1 System by applying an HotFix to the DeltaV system.
- With MX controllers, this interface requires DeltaV software release v10.3 or later.
- Each system requires one DeltaV ProfessionalPLUS Station. Additional Compatibilities

Additional Compatibilities

- The custom migration RS3 I/O interface carrier used in this solution is not compatible with a DeltaV Virtual I/O Module (VIM) from MYNAH Technologies.
- This solution is not compatible with DeltaV M-Series Zone 2 Remote I/O products.
- This migration controller solution does not support the assignment of native Smart Wireless Gateways.
- This M-Series solution is not compatible with the >=v11 S-Series products either on the railbus connector or installed on the RS3 I/O interface carrier.

If possible, prior to installing DeltaV Controller Interface for RS3 I/O, download the most current version of software for your RS3 I/O firmware. To verify compatibility, print “FS:” MTCC/System Manager screens and check “S-Rev” and “F-Rev” on the printouts against the following table “SW Rev” and “FW Rev” data.

Supported RS3™ I/O				
IO Card Type	IO Card Tested		Current Versions (from P1R4.2 Release Notes)	
Description	SW Rev	FW Rev	SW Rev	FW Rev
Analog FIC	1.6, 3.8, 4.7, 4.8	1.0, 2.1	4.8	2.1
Analog FIC HART	4.8	2.1	4.8	2.1
Analog FIC TC/RTD	2.11, 3.1	1.8	3.1	1.8
Pulse FIC	n/a	2.4, 2.7	n/a	2.7
Contact FIC	n/a	2.0, 3.1	n/a	3.1
MAI-16 FIM	2.2, 2.4, 3.4	1.1, 4.0, 4.1, 5.0	3.4	5.0
MAI-32 FIM	3.4	5.1	3.4	5.1
MAO-16 FIM	2.2, 2.6, 3.4	4.1, 5.1	3.4	5.1
MDIO FIM	3.0, 3.1, 3.2, 3.4, 4.0	1.1, 6.6, 6.7	4.0	6.6 (low side) 6.7 (high side)

To locate a sales office near you, visit our website at:

www.EmersonProcess.com/DeltaV

Or call us at:

Asia Pacific: 65.6777.8211

Europe, Middle East: 41.41.768.6111

North America, Latin America: +1 800.833.8314 or
+1 512.832.3774

© Emerson Process Management 2013. All rights reserved. For Emerson Process Management trademarks and service marks, go to:
<http://www.emersonprocess.com/home/news/resources/marks.pdf>.

The contents of this publication are presented for informational purposes only, and while every effort has been made to ensure their accuracy, they are not to be construed as warranties or guarantees, express or implied, regarding the products or services described herein or their use or applicability. All sales are governed by our terms and conditions, which are available on request. We reserve the right to modify or improve the design or specification of such products at any time without notice.

