

Instruction Manual

51-DO-03/04/rev.C

October 2004

Model DO-03/04

Dissolved Oxygen Measurement System
with Air Blast Cleaner

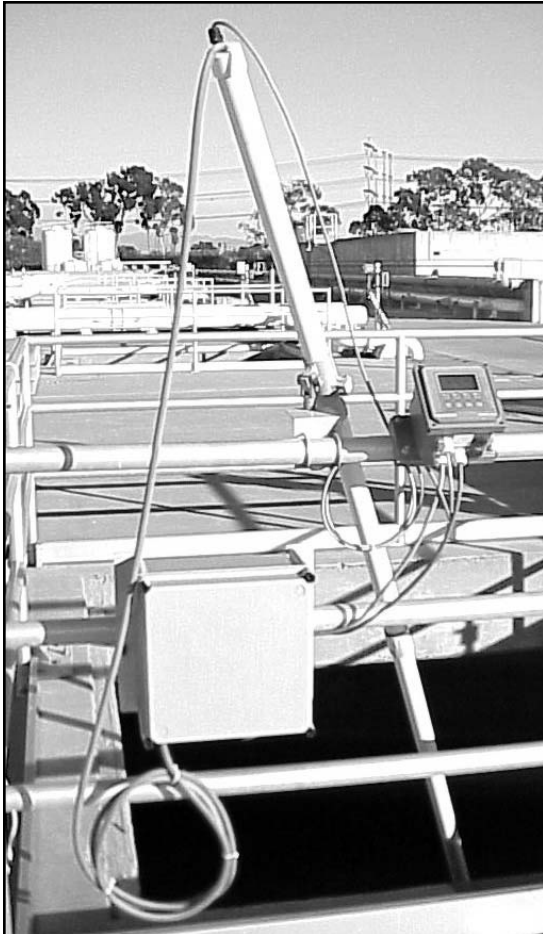

ESSENTIAL INSTRUCTIONS

READ THIS PAGE BEFORE PROCEEDING!

Rosemount Analytical designs, manufactures, and tests its products to meet many national and international standards. Because these instruments are sophisticated technical products, you must properly install, use, and maintain them to ensure they continue to operate within their normal specifications. The following instructions must be adhered to and integrated into your safety program when installing, using, and maintaining Rosemount Analytical products. Failure to follow the proper instructions may cause any one of the following situations to occur: Loss of life; personal injury; property damage; damage to this instrument; and warranty invalidation.

- Read all instructions prior to installing, operating, and servicing the product. If this Instruction Manual is not the correct manual, telephone 1-800-654-7768 and the requested manual will be provided. Save this Instruction Manual for future reference.
- If you do not understand any of the instructions, contact your Rosemount representative for clarification.
- Follow all warnings, cautions, and instructions marked on and supplied with the product.
- Inform and educate your personnel in the proper installation, operation, and maintenance of the product.
- Install your equipment as specified in the Installation Instructions of the appropriate Instruction Manual and per applicable local and national codes. Connect all products to the proper electrical and pressure sources.
- To ensure proper performance, use qualified personnel to install, operate, update, program, and maintain the product.
- When replacement parts are required, ensure that qualified people use replacement parts specified by Rosemount. Unauthorized parts and procedures can affect the product's performance and place the safe operation of your process at risk. Look alike substitutions may result in fire, electrical hazards, or improper operation.
- Ensure that all equipment doors are closed and protective covers are in place, except when maintenance is being performed by qualified persons, to prevent electrical shock and personal injury.

WARNING

ELECTRICAL SHOCK HAZARD

Making cable connections to and servicing this instrument require access to shock hazard level voltages which can cause death or serious injury, therefore, disconnect all hazardous voltage before accessing the electronics.

Relay contacts made to separate power sources must be disconnected before servicing.

Electrical installation must be in accordance with the National Electrical Code (ANSI/NFPA-70) and/or any other applicable national or local codes.

Unused cable conduit entries must be securely sealed by non-flammable closures to provide enclosure integrity in compliance with personal safety and environmental protection requirements. Use NEMA 4X or IP65 conduit plugs supplied with the instrument to maintain the ingress protection rating (IP65).

For safety and proper performance this instrument must be connected to a properly grounded three-wire power source.

Proper relay use and configuration is the responsibility of the user. No external connection to the instrument of more than 60VDC or 43V peak allowed with the exception of power and relay terminals. Any violation will impair the safety protection provided.

Do not operate this instrument without front cover secured. Refer installation, operation and servicing to qualified personnel.

WARNING

This product is not intended for use in the residential, commercial or light industrial environment per **CE** certification to EN61326.

About This Document

This manual contains instructions for installation and operation of the Model DO-03/04. The following list provides notes concerning all revisions of this document.

<u>Rev. Level</u>	<u>Date</u>	<u>Notes</u>
A	1/04	This is the initial release of the product manual. The manual has been reformatted to reflect the Emerson documentation style and updated to reflect any changes in the product offering.
B	5/04	Drawings and part numbers were updated on pages 5, 6, 7, and 51.
C	10/04	Updated Specifications, Section 1.0.

Emerson Process Management

Rosemount Analytical Inc.

2400 Barranca Parkway
Irvine, CA 92606 USA
Tel: (949) 757-8500
Fax: (949) 474-7250

<http://www.raihome.com>



EMERSON[™]
Process Management

CAUTION

Ground conduit to metal stiffener or to metal enclosure. Use non-flammable watertight conduit fittings/plugs to preserve enclosure rating.

DANGER

 **LIVE VOLTAGES MAY BE PRESENT**
When fuse or this cover is removed will cause severe injury or death.

CAUTION

For continued protection against fire, replace only with fuses of specified voltage and current ratings. Fuses are located under this cover.

VAROVANI

Zemnici vodici musi byt vodive spojen s kostrou pristroje. Pouzivejte nehorlavé vodotesné pruchodky, aby ste zachovali stupeň kryti pristroje.

NEBEZPECI

 **ZARIZENI POD NAPETIM**
Odstraneni pojistiky nebo tohoto krytu muze zpusobit vazne zraneni nebo smrt.

VAROVANI

Poskozene pojistiky nahrazujte pouze pojistkami se stejnym jmenovitym napetim a proudem. Pojistky jsou umisteny pod timto krytem.

FORSIGTIG

Brug uantændelig vandtæt forskrning som sikkerhed for bevaring af kapslings klasse.

Jordforbindelse til metal kapsel.

FARE

 **UBESKYTTET SPÆNDING**
Hvis sikringen eller denne påskrift fjernes kan dette medføre alvorlige kvæstelser eller død.

FORSIGTIG

Brug kun sikringer med nærmere angivet spænding og strømstyrke som sikkerhed for vedvarende beskyttelse mod brandfare. Sikringerne er placeret under denne påskrift.

ATENCION

La toma a tierra debe hacerse a un contrafuerte de metal o a la caja metálica. Utilice accesorios/enchufes no inflamables y estancos al agua para preservar las especificaciones de la caja.

PELIGRO

 **VOLTAJE PUEDE ESTAR PRESENTE**
Cuando los fusibles o esta cubierta son removidos causará severas lesiones o muerte.

ATENCION

Para una proteccion continua contra el fuego, reemplace solamente con fusibles de voltaje y corriente especificados. Los fusibles se encuentran debajo de esta cubierta.

VOORZICHTIG

Aardleiding naar metalen profiel of naar metalen behuizing. Gebruik onbrandbare, waterdichte wartels en pluggen om de beschermingsklasse te handhaven.

GEVAAR

 **KAN ONDER SPANNING STAAN**
Verwijderen van zekering of dit deksel kan dit leiden tot ernstig of dodelijk letsel.

VOORZICHTIG

Voor duurzame bescherming tegen brand, uitsluitend zekeringen gebruiken met aangegeven nominale spannings- en stroomwaarden. De zekeringen bevinden zich onder dit deksel.

ATTENTION

Raccorder le tube à la masse métallique d'une entretoise ou du coffret. Utiliser des raccords et des bouchons étanches ininflammables afin de préserver la classification du boîtier.

DANGER

 **POSSIBILITE DE HAUTE TENSION**
En cas de démontage de ce capot ou des fusibles. Risques de Blessures graves ou de mort

ATTENTION

Afin d'assurer une protection permanente contre le feu, ne remplacer les fusibles que par des modèles équivalents en tension et en courant. Les fusibles se trouvent derriere cette plaquette.

ADVARSEL

Kabelinnføring må jordes til metallavstiver eller til metallkapslingen. Bruk flammesikre og vannette nipler/plugger slik at kapslingens tetthetsgrad opprettholdes.

FARE

 **SPENNING KAN VÆRE TIL STEDE**
når sikringen eller dette dekslet fjernes, og kan føre til alvorlige skader eller dødsulykker.

ADVARSEL

For at beskyttelse mot antennelse skal opprettholdes, må sikringer bare erstattes med tilsvarende som har spesifisert spenning- og strømstyrke. Sikringer er plassert under dette dekslet.

ACHTUNG

Der Analysator ist vorschriftsmässig zu erden.

Um die Schutzart des Gerätes sicherzustellen ist es mit den entsprechenden Kabelverschraubungen und Blindkappen auszurüsten.

ACHTUNG

 **GEFAEHRliche ELEK-TRISCHE SPANNUNG**
Ist die Schutzabdeckung oder die Sicherung entfernt, so koennen am Geraet ernsthafte oder toedliche Verletzungen entstehen.

ATTENTION

Um die Gefahr von Kurzschluß und Funkenbildung zu verhindern dürfen die Sicherungen nur durch solche gleicher Spannung und Stromwerte ausgetauscht werden. Die Sicherungen befinden sich unter dieser Abdeckung.

Attenzione

Tubo di protezione per messa a terra con elemento di ingresso in metallo o con custodia in metallo.

Utilizzare accessori/connettori del tubo di protezione a tenuta stagna, non infiammabili, per assicurare i limiti di resistenza della custodia

Pericolo

 **POSSIBILE PRESENZA DI ALTA TENSIONE**
La rimozione del fusibile o del coperchio può causare gravi lesioni o morte.

ATTENZIONE

Per garantire una continua protezione contro gli incendi, sostituire solo con fusibili del voltaggio indicato e dell'attuale potenza. I fusibili sono alloggiati sotto il coperchio.

UWAGA

Uziemij przewod do metalowego płaskownika lub obudowy. Aby zachowac stopien szczelnosci obudowy stosuj niepalne, wodoszczelne dławiki.

NIEBEZPIECZENSTWO

 **URZADZENIE MOZE BYC POD NAPIECIEM**
Gdy bezpieczniki lub ta pokrywa sa usunięte istnieje mozliwosc uszkodzenia ciała lub smierci.

UWAGA

W celu utrzymania zabezpieczenia przed zapaleniem, należy stosowac bezpieczniki o identycznym z oryginalnym napięciu i amperazu. Bezpieczniki sa umieszczone pod ta pokrywa.

ATENÇÃO

Ligar a conducta de cabos à terra através de suporte ou invólucro metálicos. Utilize buçins e acessórios ignífugos e estanques para preservação da estanqueidade.

PERIGO

 **POSSIBILIDADE DE TENSÃO PERIGOSA**
A remoção do fusível ou desta tampa pode causar lesões graves ou a morte.

ATENÇÃO

Para manter sempre uma boa proteção contra incêndio, substituir somente por fusíveis com a tensão e corrente especificadas. Os fusíveis encontram-se sob esta tampa.

IAKTTAG FÖRSIKTIGHET

Anslutningspunkt är jordad till chassi. Använd brandsäker, vattentät kabelanslutning för att bevara klassificering av apparatskåp.

FARA

 **HÖGSPÄNNING KAN FÖREKOMMA**
Avlägsnande av säkring eller skyddskåpa kan förorsaka allvarlig skada eller dödsfall

IAKTTAG FÖRSIKTIGHET

För kontinuerligt skydd mot brandfara, ersätt endast med specificerad säkringsstorlek och spänning.

MODEL DO-03/04 MEASURING SYSTEM

TABLE OF CONTENTS

Section Title	Page
1.0 SPECIFICATIONS	1
1.1 Features and Applications	1
1.2 Specifications.....	2
1.3 Ordering Information.....	6
2.0 INSTALLATION	7
2.1 Unpacking and Inspection	7
2.2 Installation.....	7
3.0 WIRING	12
3.1 General.....	12
3.2 Power, Alarm, and Output Wiring	12
3.3 Sensor Wiring.....	16
4.0 DISPLAY AND OPERATION	17
4.1 Display.....	17
4.2 Key Functions and Control	17
4.3 Alarm Status	17
5.0 SOFTWARE CONFIGURATION	18
5.1 Changing Alarm Setpoints	24
5.2 Ranging the Outputs.....	25
5.3 Testing Outputs and Alarms	26
5.4 Choosing Display Options	27
5.5 Changing Output Parameters.....	29
5.6 Changing Alarm Parameters	31
5.7 Temperature Compensation and Temperature Units.....	35
5.8 Noise Reduction	36
5.9 Barometric Pressure.....	37
5.10 Main Sensor Calibration Parameters	38
5.11 Security.....	39
5.12 Analyzer Mode Priority	40
6.0 CALIBRATION - TEMPERATURE	41
6.1 Introduction	41
6.2 Temperature Calibration	42
7.0 CALIBRATION - DISSOLVED OXYGEN	43
7.1 Introduction	43
7.2 Zeroing the Sensor	44
7.3 Calibrating the Sensor in Air.....	45
7.4 Calibrating the Sensor Against a Standard Instrument	47
7.5 Calibrating Barometric Pressure.....	48
8.0 CALIBRATION - CURRENT OUTPUTS	49
8.1 Introduction	49
8.2 Trimming the Outputs	49

TABLE OF CONTENTS (CONTINUED)

Section	Title	Page
9.0	MAINTENANCE	50
9.1	Analyzer (Model 54eA-01).....	50
9.2	Oxygen Sensor (Model 499ADO-54)	50
9.3	Air Compressor.....	52
9.4	Air Blast Sensor Washer	53
10.0	TROUBLESHOOTING	54
10.1	Overview.....	54
10.2	Troubleshooting When a Fault Message is Showing	54
10.3	Troubleshooting When No Fault Message is Showing - Temperature	56
10.4	Troubleshooting When No Fault Message is Showing - Oxygen.....	56
10.5	Troubleshooting Not Related to Measurement Problems	59
10.6	Simulating Inputs - Dissolved Oxygen.....	59
10.7	Simulating Temperature.....	60
11.0	RETURN OF MATERIALS.....	61

LIST OF TABLES

Table No.	Title	Page
5-1	Program Settings List.....	21
5-2	Controller Mode Priority Chart.....	40
9-1	Replacment Parts	50

LIST OF FIGURES

Section	Title	Page
1-1	Suggested Arrangement of Handrail Mounting Assembly, Maintenance Clamp, ... Air Compressor Enclosure, and 54eA Analyzer	4
1-2	Analyzer Dimensions	4
1-3	Enclosure Dimensions	5
1-4	Standard Sensor with Integral Cable	5
1-5	Air Blast Washer Head	5
2-1	Suggested Arrangement of Handrail Mounting Assembly, Maintenance Clamp, ... Air Compressor Enclosure, and 54eA Analyzer	8
2-2	Pipe Mounting	8
2-3	Attaching the Air Compressor Enclosure to the Handrail	10
2-4	Assembling and Attaching the Handrail Mounting Assembly	10
2-5	Installing the Sensor in the Washer Head Assembly	11
3-1	Power Input, Relay, and Output Wiring for 54eA Analyzer	13
3-2	Model DO-03 — Wiring Air Blast Compressor to Model 54eA Analyzer 115 Vac..	14
3-3	Model DO-04 — Wiring Air Blast Compressor to Model 54eA Analyzer 230 Vac..	15
3-4	Wiring Label	16
3-5	Oxygen Sensor with Standard Cable	16
3-6	Oxygen Sensor with Optimum EMI/RFI Cable or Variopol Cable	16
4-1	Main Display Screen	17
5-1	Menu Tree for the 54eA Analyzer	18
5-2	Low Alarm	32
5-3	High Alarm	32
5-4	Interval Timer	34
7-1	Sensor Current as a Function of Dissolved Oxygen Concentration	43
9-1	Sensor Parts	52
9-2	Replacement Parts	53
10-1	Simulate Dissolved Oxygen	59
10-2	Three-Wire RTD Configuration	60
10-3	Simulating RTD Inputs	60

SECTION 1.0 SPECIFICATIONS

- COMPLETE SYSTEM INCLUDES sensor, analyzer, sensor washer head, mounting hardware, and air compressor.
- AIR BLAST CLEANER system can keep DO sensors functioning up to 3 months or longer.
- SENSOR MAINTENANCE is quick and easy.
- FEATURE-PACKED ANALYZER: on-board pressure sensor for completely automatic air calibration, large backlit display, dual outputs, three fully programmable alarm relays.

FEATURES AND BENEFITS

The Model DO-03/04 is a complete system for the determination of dissolved oxygen in wastewater aeration basins. It consists of a sensor, an analyzer, a handrail mounting assembly, a sensor washer head, and an air compressor. A timer in the analyzer allows the user to customize the air blast cleaning cycle.

The Model DO-03/04 uses a membrane-covered amperometric sensor. A polarizing voltage applied to a gold cathode behind the membrane destroys oxygen diffusing through the membrane and keeps the concentration of oxygen in the sensor equal to zero. The current generated by the cathode reaction is proportional to the rate of diffusion of oxygen through the membrane. Because the concentration of oxygen in the sensor is zero, the diffusion rate and the current are proportional to the concentration of oxygen in the sample.

Sensor maintenance is fast and easy. Replacing a membrane requires no special tools or fixtures. A screw cap holds the pre-tensioned membrane in place. Replacing the electrolyte solution takes only minutes.

The Model DO-03/04 includes the rugged, easy-to-use Model 54eA analyzer. The analyzer features two fully programmable 4-20 mA outputs, and three fully programmable alarm relays. The backlit three line display allows the user to read oxygen levels at a glance. The analyzer permits both air calibration and calibration against a laboratory instrument. Air calibration is completely automatic. All the user does is expose the sensor to water-saturated air and press a few buttons.

The Air Blast Sensor Cleaner, which includes the washer head and air compressor, keeps the sensor membrane clean, helping ensure reliable, trouble-free oxygen measurements and reducing sensor cleaning maintenance to as little as every three months. At programmed intervals, the air blast cleaner blows a stream of air across the membrane to clear bio-film from on the membrane. The frequency and duration of the air blast is programmable from the 54eA analyzer.

The photograph shows a sensor after nine weeks in an aeration basin. The cathode is clearly visible under the membrane. A 60-second air blast every eight hours is keeping the membrane clean.

Plant service air can be used in place of the air compressor. The 54eA analyzer relay is then used to operate a solenoid valve.

SPECIFICATIONS - 499ADO-54 SENSOR

Range: 0 to 20 ppm (mg/L)
Wetted parts: Noryl¹ Viton² EPDM, Teflon³, silicone
Cathode: Gold (not normally wetted)
Accuracy: ±0.2 ppm at 25°C
Repeatability: ±0.05 ppm 25°C
Response time: 25 sec to 63% of final reading at 25°C
Pressure: 0 to 65 psig (0 to 549 kPa abs)
Temperature: 32 to 122°F (0 to 50°C)
Process connection: 1 inch MNPT
Electrolyte volume: 25 mL (approx.)
Cable length (standard): 25 ft (7.6 m)
Cable length (maximum): 300 ft (91 m)

SPECIFICATIONS - 54EA-01 ANALYZER

Enclosure: Epoxy-painted (light gray) cast aluminum, NEMA 4X (IP65). 144 x 144 x 132 mm (5.7 x 5.7 x 5.2 in.), DIN size panel cut-out.
Front Panel: Membrane keypad with tactile feedback. Three green LEDs indicate alarm status. Red LED indicates fault condition.
Display: Three-line, back-lit, dot matrix LCD, 70 x 35 mm. First line is oxygen reading. Second line is temperature and current output. Third line is user-selectable. Character heights: 1st line - 16 mm (0.6 in.), 2nd and 3rd lines - 7 mm (0.3 in.).
Power:
 115 VAC ± 10%, 50/60 Hz ± 6%, 8 W
 230 VAC ± 10%, 50/60 Hz ± 6%, 8 W

RFI/EMI: EN-61326



LVD: EN-61010-1

Outputs: Two 4-20 mA or 0-20 mA isolated outputs. Continuously adjustable. Outputs can be assigned to oxygen or temperature. Output dampening is user-selectable. Maximum load at 100/200 Vac is 550 ohms.

Output Accuracy: ± 0.05 mA

Alarms: Relays 1, 2, and 3 are assignable to oxygen or temperature. One relay can also be used as an interval timer to operate the air blast cleaner.



Relay 4 - Sensor/analyzer fault alarm

Each relay has a dedicated LED on the front panel.

Relay Contacts: Relays 1-3: Epoxy sealed form A contacts, SPST, normally open



Relay 4: Epoxy sealed form C, SPDT

	<u>Resistive</u>	<u>Inductive</u>
115 Vac	5.0 Amps	3.0 Amps
230 Vac	5.0 Amps	1.5 Amps

Ambient Temperature: 0 to 50°C (32 to 122°F). Analyzer can be operated between -20 and 60°C (-4 to 140°F) with some degradation in display quality.

Relative Humidity: 95% (maximum) non-condensing
Temperature correction for membrane permeability: automatic between 0 and 50°C.

Calibration: automatic air calibration or calibration against a standard instrument

Pressure sensor range: 113 to 862 mm Hg (150 to 1150 mbar)

¹Noryl is a registered trademark of General Electric

²Viton is a registered trademark of E.I. duPont de Nemours & Co.

³Teflon is a registered trademark of E.I. duPont de Nemours & Co.

**SPECIFICATIONS - COMPRESSOR FOR
AIR BLAST CLEANER SYSTEM**

Enclosure: Fiberglass reinforced polyester with polyester cover, NEMA 4x (IP65). 11.9 x 11.9 x 6.9 in (302 x 302 x 175 mm).

Compressor: Oil-less, non-lubricating piston and cylinder. 1/12 HP permanent split capacitor motor with thermal overload protection.

Maximum continuous pressure: 50 psig (446 kPa abs)

Operating pressure: 20 psig (239 kPa abs)

Air hose: 25 ft (7.6 m) included with ABSH

Ambient temperature: 5 to 122°F (-15 to 50°C) assuming intermittent operation

Power:

Code -03: 115 VAC, 60 Hz or 100 VAC, 50/60 Hz, single phase, 1.3 to 1.4 A, starting current 3.88 A, insulation class B; UL approved



Code -04: 220 VAC, 50 Hz, single phase, 0.6 A, starting current 1.5 A, insulation class A; CE approved

**SPECIFICATIONS - AIR BLAST CLEANER
SYSTEM WASHER HEAD**

Process connection: 1-1/2 inch PVC pipe socket

Dimensions (diameter x length): 2-1/2 x 10-3/4 inches (64 x 273 mm)

Wetted materials: PVC, Noryl, Viton

Pipe boom: 1-1/2 inch schedule 80 PVC, maximum length 12 feet (3.6 m) past handrail mounting clamp. Pipe boom is supplied by customer.

Maximum distance between compressor and sensor: 25 ft (7.6 m). ABSH is supplied with 25 ft (7.6 m) of air hose.

**SPECIFICATIONS - HANDRAIL MOUNTING
ASSEMBLY****Materials of Construction:**

Weather cap: Schedule 40 PVC

Pipe clamp and bracket: Aluminum

Clevis: zinc-plated steel

U-bolts, nuts, and bolts: zinc-plated steel

Washers: stainless steel

SHIPPING INFORMATION

The Model DO-03/04 is shipped in a single container. Shipping weight is 38 lbs (17.5 kg).

PLANT AIR SYSTEM REQUIREMENTS

(for customers using plant air in place of air compressor)

Pressure: 20 psig (239 kPa abs)

Flow: 0.50 SCFM (14 L/min at STP)

Air hose: (customer supplied) compatible with ¼ inch barbed fitting for connection at washer head

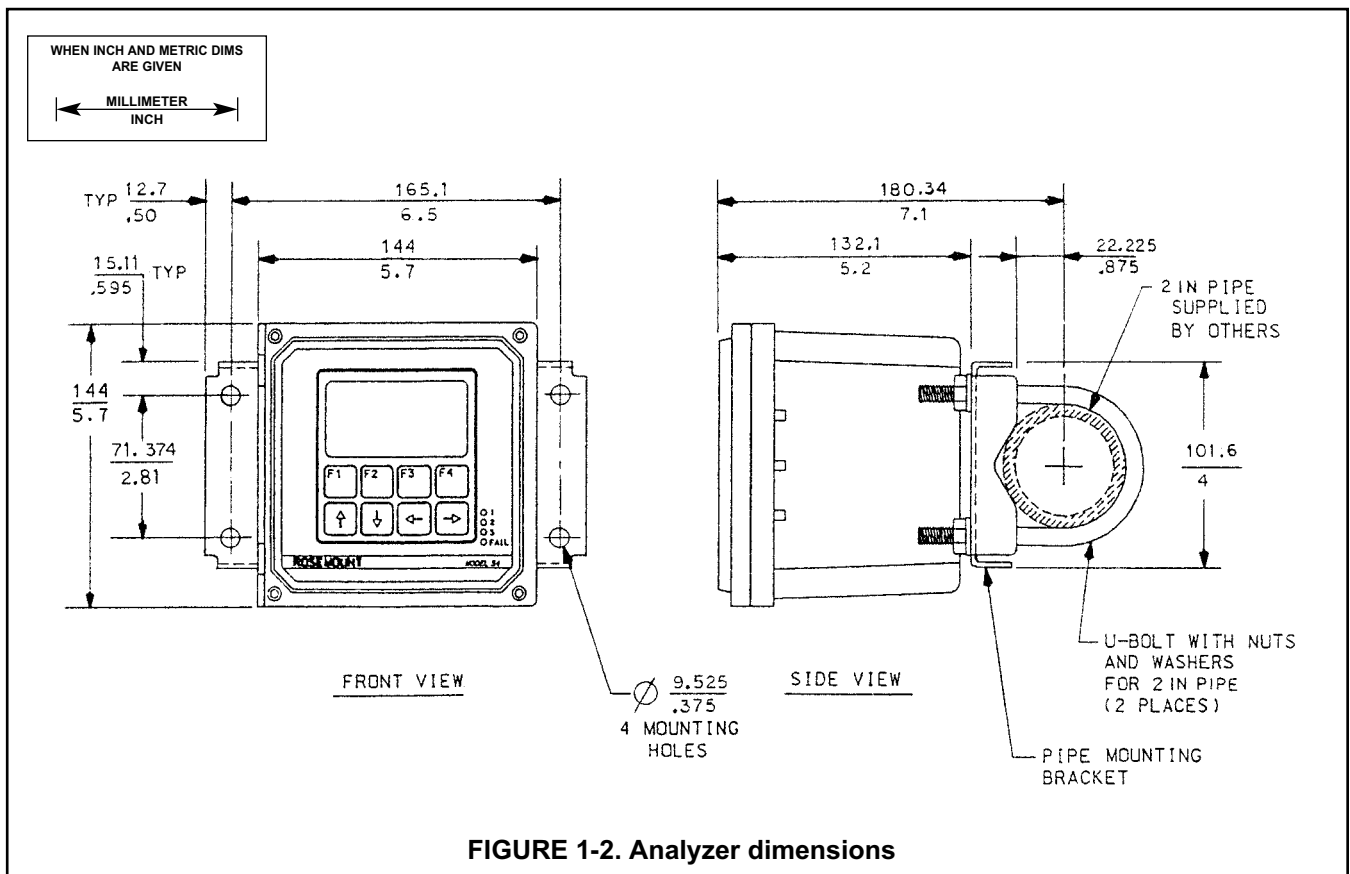
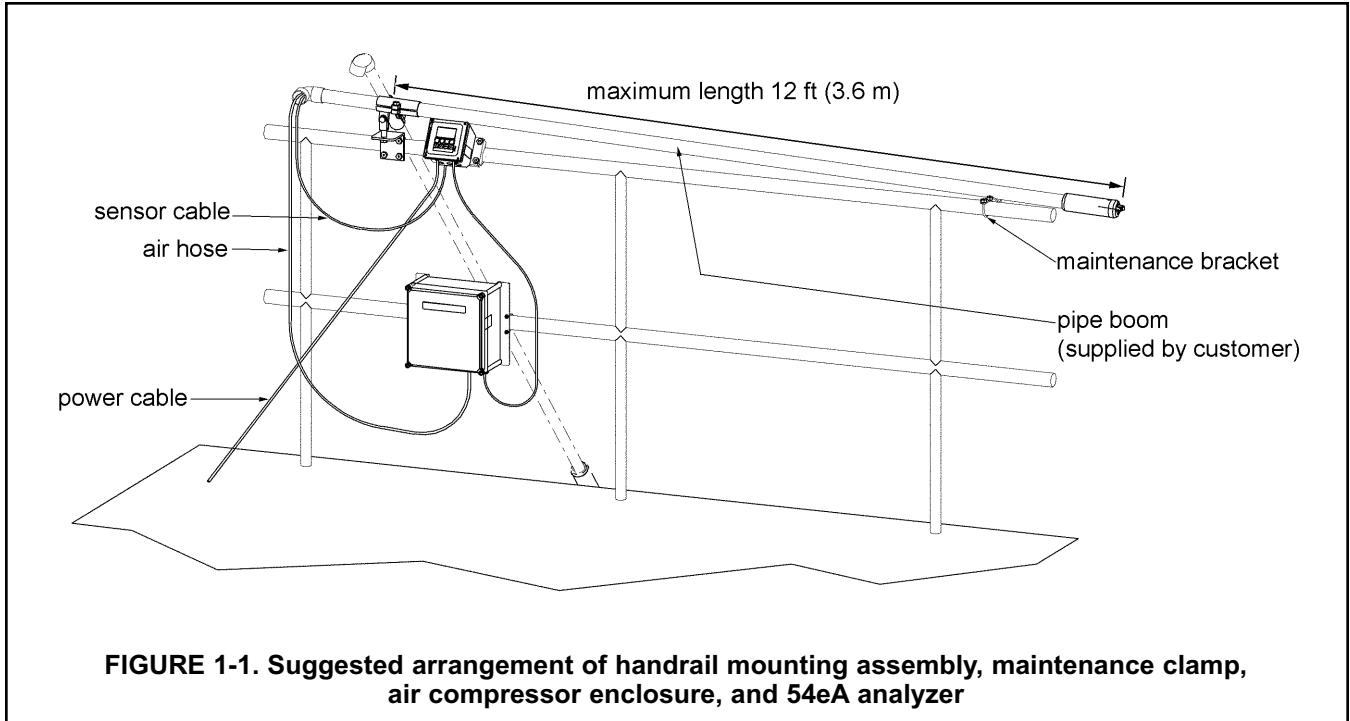

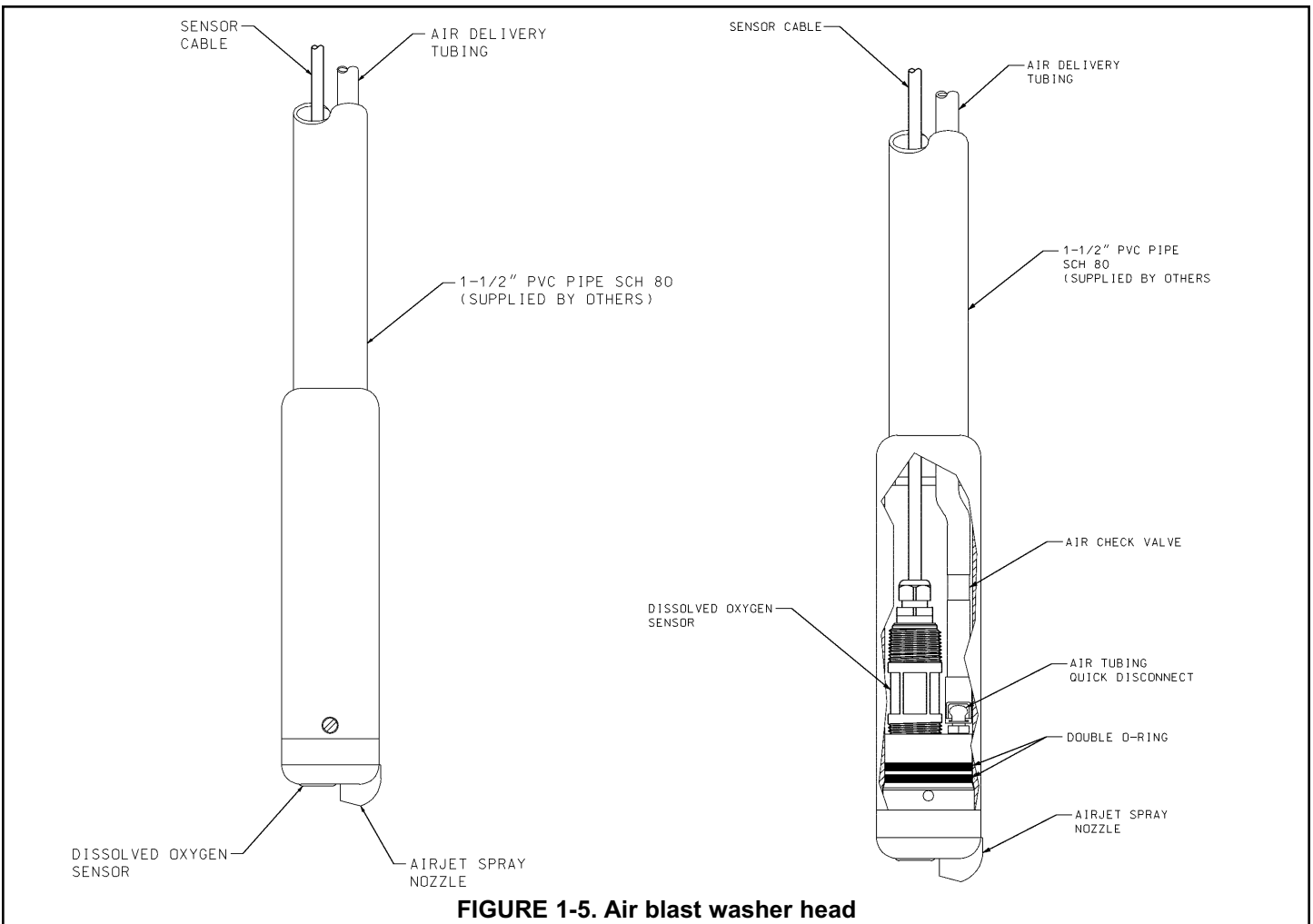
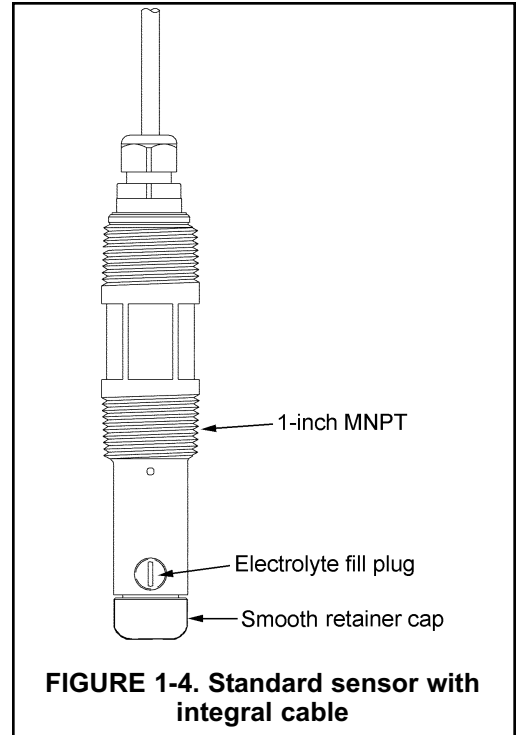
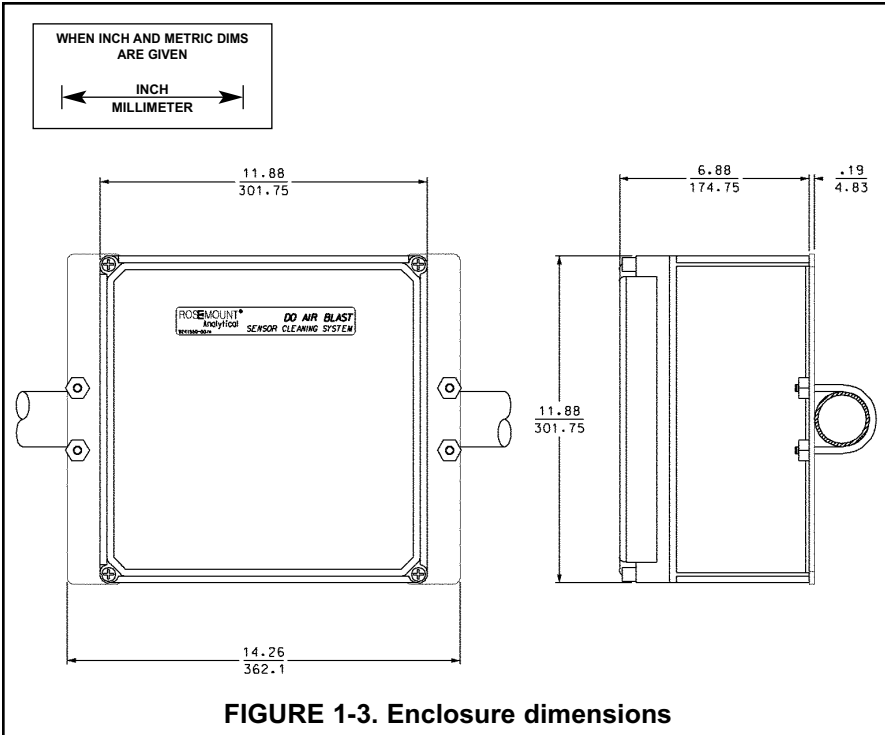

ORDERING INFORMATION

The Model DO -03/04 is a complete system for the determination of oxygen in wastewater aeration basins. It consists of a 54eA analyzer, a 499ADO-54 oxygen sensor, an air blast washer head with air compressor and hose, and a handrail mounting bracket. All hardware necessary to mount the analyzer and the air compressor enclosure on a handrail is provided. Cable gland fittings for the analyzer are also supplied. Three replacement membranes and a bottle of electrolyte solution are shipped with the sensor. Pipe boom is supplied by customer.

MODEL DO DISSOLVED OXYGEN MEASURING SYSTEM WITH AIR BLAST CLEANER	
MODEL	Description
DO	Dissolved Oxygen Measuring System
CODE	Power (required selection)
-03	115 Vac, 60 Hz or 100 Vac, 50/60 Hz
-04	220 Vac, 50 Hz
DO -03	EXAMPLE

ACCESSORIES FOR 54eA ANALYZER

Part #	DESCRIPTION
9240048-00	Tag, stainless steel, specify marking

CONSUMABLES FOR SENSOR

Part #	DESCRIPTION
23502-00	Membrane replacement kit with O-ring, qty 3
9210264	Amperometric sensor fill solution #1, 4 oz (120 mL)

Customers using plant compressed air should order the following items in place of Model -03/04:

54e-A-01	Model 54eA analyzer
2002577	Mounting bracket for Model 54e, pipe/wall
23554-00	Cable glands kit for Model 54e, qty 5
499ADO-54	Model 499ADO oxygen sensor
24057-00	Smooth membrane retainer for 499ADO sensor
HRMS-02	Handrail clamp assembly for washer head (clamp, sensor maintenance kit, and elbow)
9320101	Elbow, 90° female socket, PVC schedule 40
24049-00	Air blast washer head
9160549	Air hose, 1/4-inch ID x 1/2-inch OD, 25 ft (7.6 m)

REPLACEMENT PARTS AND ACCESSORIES

9380088	Air compressor; 115 Vac, 60 Hz or 100 Vac, 50/60 Hz
9380089	Air compressor; 220 Vac, 50 Hz
24051-00	Mounting hardware for air compressor enclosure
24053-00	O-ring kit for sensor washer head (three O-rings and lube)

SECTION 2.0 INSTALLATION

2.1 UNPACKING AND INSPECTION

Inspect the shipping container. If it is damaged, contact the shipper immediately for instructions. If there is no apparent damage, unpack the container. Be sure all items shown on the packing list are present. If items are missing, notify Rosemount Analytical immediately.

The Model DO-03/04 consists of the following items.

Model or part number	Description
54e-A-01	Model 54eA analyzer
2002577	Mounting bracket for Model 54e, pipe/wall
23544-00	Cable glands kit for Model 54e, qty 5
499ADO-54	Model 499ADO oxygen sensor
24057-00	Smooth membrane retainer for 499ADO sensor
HRMS-02	Handrail clamp assembly (clamp, sensor maintenance kit, and elbow)
24049-00	Air blast washer head
24050-00	Air compressor and enclosure with air hose (115 VAC) option -03 only
24050-01	Air compressor and enclosure with air hose (220 VAC) option -04 only
24051-00	Mounting hardware for air compressor enclosure
24053-00	O-ring kit for sensor washer head (three O-rings and lube)

The customer must supply a schedule 80 1-1/2 inch PVC pipe boom to immerse the sensor and cleaning head in the aeration basin.

2.2 INSTALLATION

2.2.1 General information

1. Although the equipment is suitable for outdoor use, do not install it in direct sunlight or in areas of extreme temperatures.
2. Install the equipment in an area where vibrations and electromagnetic and radio frequency interference are minimized or absent.
3. To keep the analyzer watertight, install plugs (provided) in the unused cable openings.
4. Keep the analyzer and sensor wiring at least one foot from high voltage conductors. Be sure there is easy access to the analyzer.
5. Provide room to allow the sensor and attached piping to be removed from the aeration basin for service. A maintenance bracket (part of PN 24048-00) can be used to rest the PVC pipe boom on the handrail.

Figure 2-1 shows the suggested arrangement of the analyzer, air compressor, and maintenance bracket on the handrail.

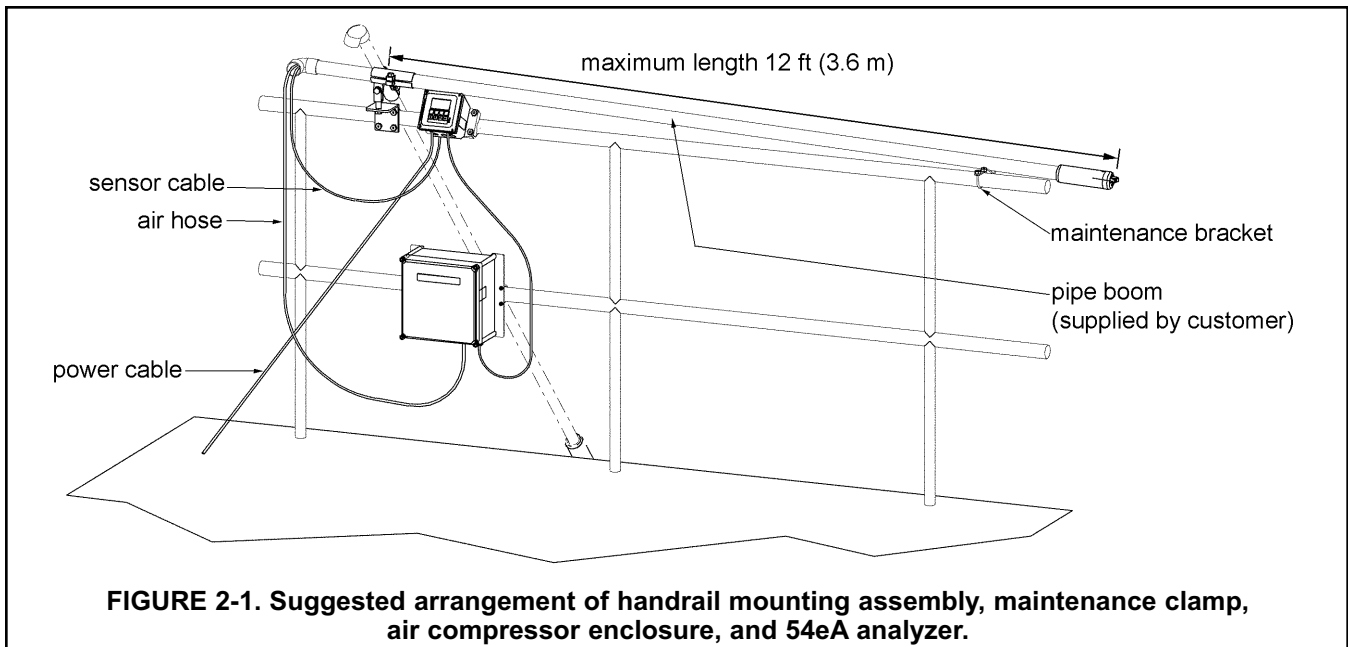

2.2.2 Installing the analyzer

When used in Model DO-03/04, the 54eA analyzer is intended to be mounted on the basin handrail. See Figures 2-1 and 2-2.

2.2.3 Installing the air compressor enclosure

The air compressor is in a NEMA 4X fiberglass enclosure. Figure 2-3 shows how to attach the enclosure to a handrail.

1. Locate the enclosure within 25 ft (7.6 m) of the sensor.
2. Be sure the ambient temperature is between 5 and 122°F (-15 to 50°C). Do not expose the enclosure to direct sunlight. The operating temperature for the air compressor might be exceeded.

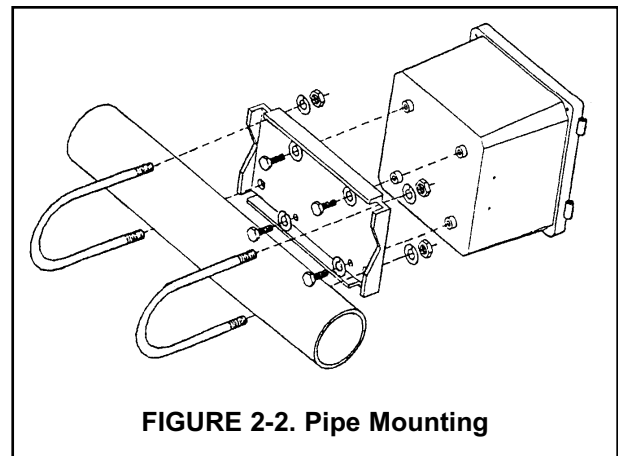

2.2.4 Installing the handrail mounting assembly

The handrail mounting assembly (PN 24048-00) is shipped completely disassembled. Assemble and attach the mounting assembly to the handrail. Refer to Figure 2-4. The spring pin shipped with the handrail mounting assembly is not needed. Do not attach the boom clamp to the clevis yet. Attach the maintenance bracket (PN 24044-00) to the handrail. See Figure 2-1.

2.2.5 Assembling the pipe and pipe clamp

Slide the PVC pipe boom through the handrail mounting pipe clamp. Tighten the bolt to keep the clamp from sliding off. Use 1-1/2 inch schedule 80 PVC piping. Distance between the clamp and the end of the pipe should not exceed 12 feet (3.6 m). See Figures 2-1 and 2-4.

2.2.6 Installing the sensor in the washer head assembly

1. Remove the sensor from its box. Remove the plastic protective cap from the end of the sensor. Save the cap.
2. Replace the knurled cap provided with the sensor with the smooth cap (PN 33521-01). The smooth cap is shipped loose.
 - a. Hold the sensor with the membrane end pointing up.
 - b. Unscrew the knurled cap. Leave the membrane in place.
 - c. Screw the smooth cap in place. Hand tighten.
 - d. Hold the sensor with the membrane end pointing down. Shake the sensor a few times as though shaking down a clinical thermometer.
 - e. Slide the protective cap back over the end of the sensor.
3. Remove the set screw at the bottom of the sensor washer head assembly. See Figure 2-5. Pull the washer head from the shank. You are pulling against a dual O-ring seal.
4. Press the metal tab on the air hose quick connect fitting and remove the fitting and check valve.
5. Wrap the bottom facing threads of the sensor with pipe tape. Remove the protective cap and slide the O-ring (PN 9550291) over the end of the sensor until it rests against the lower edge of the bottom facing thread. The O-ring is in a bag taped to the side of the washer head assembly.
6. Screw the sensor into the bottom of the washer assembly. Hand tighten only. Replace the air hose and check valve assembly.

2.2.7 Assembling the washer head and pipe boom

1. Cement the upper portion of the washer assembly head to the PVC pipe boom. See Figure 2-5. Use 1-1/2 inch schedule 80 PVC pipe. Press (do not cement) the PVC elbow (PN 9320101) to the top of the pipe boom. The elbow keeps water from collecting in the pipe boom.
2. Pass the sensor cable and air hose through the boom and elbow.
3. Connect the end of the air hose to the barbed fitting on the check valve.
4. Push the washer head back onto the shank. Use a small amount of grease to lubricate the O-rings. Replace and tighten the set screw.

2.2.8 Attaching the pipe boom to the handrail mounting assembly

1. Slide the tongue of the pipe clamp into the clevis. Insert the bolt as shown in Figure 2-3.
2. Rest the boom on the maintenance bracket until ready to submerge the sensor in the basin.

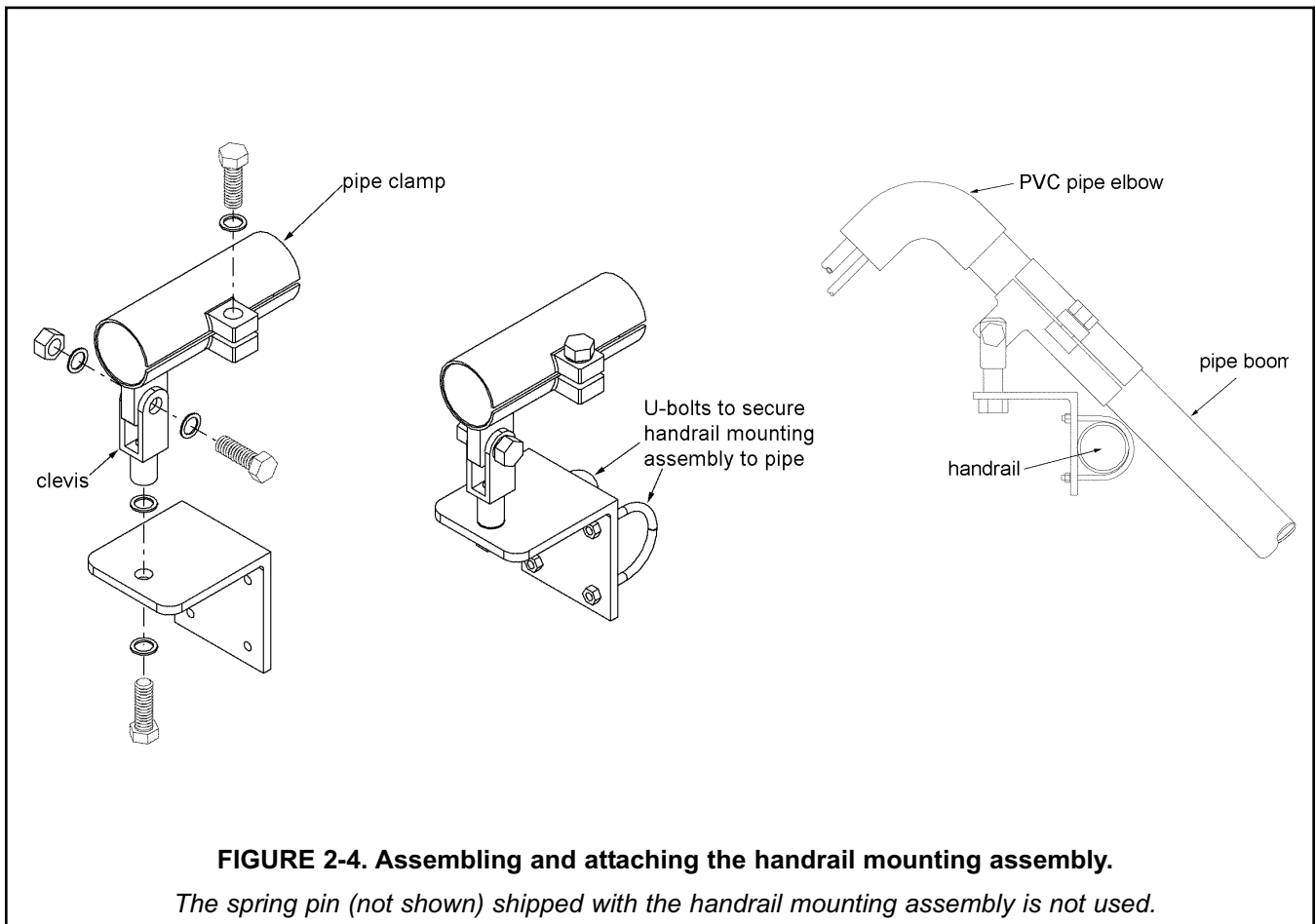
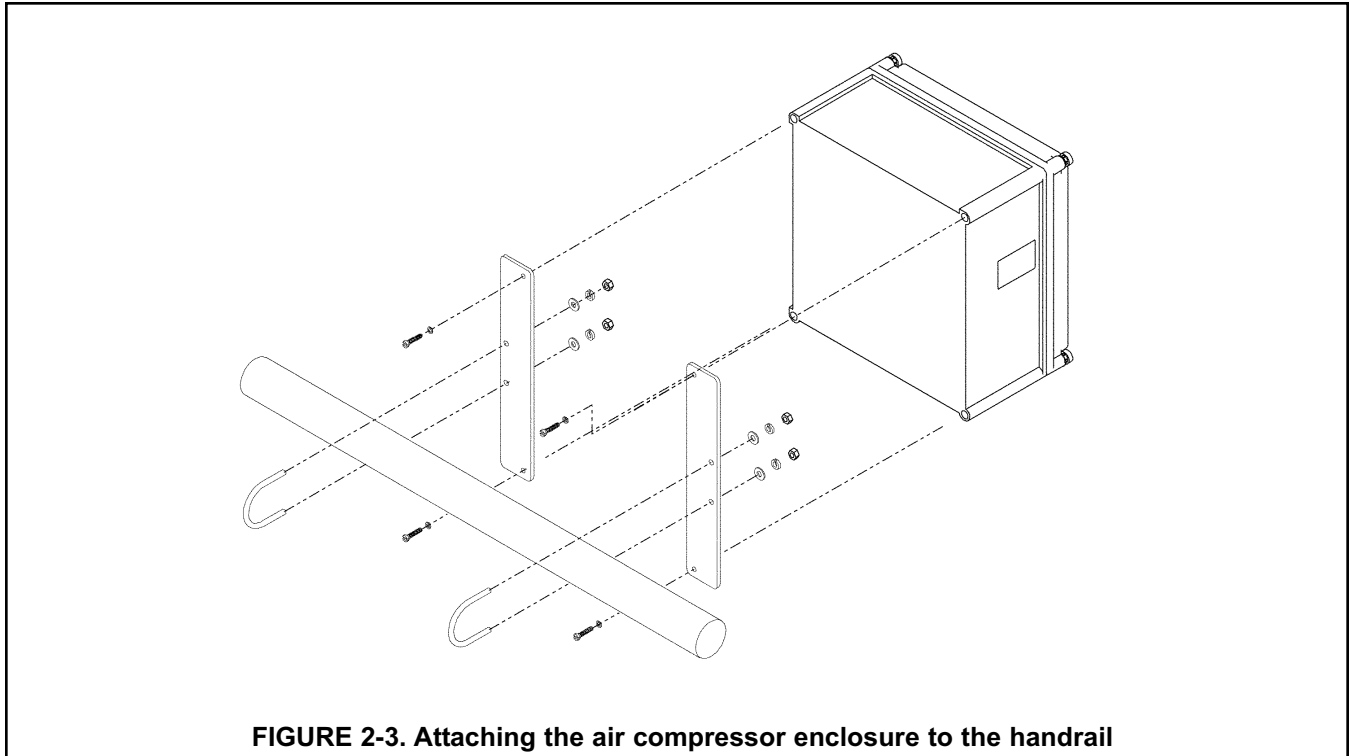

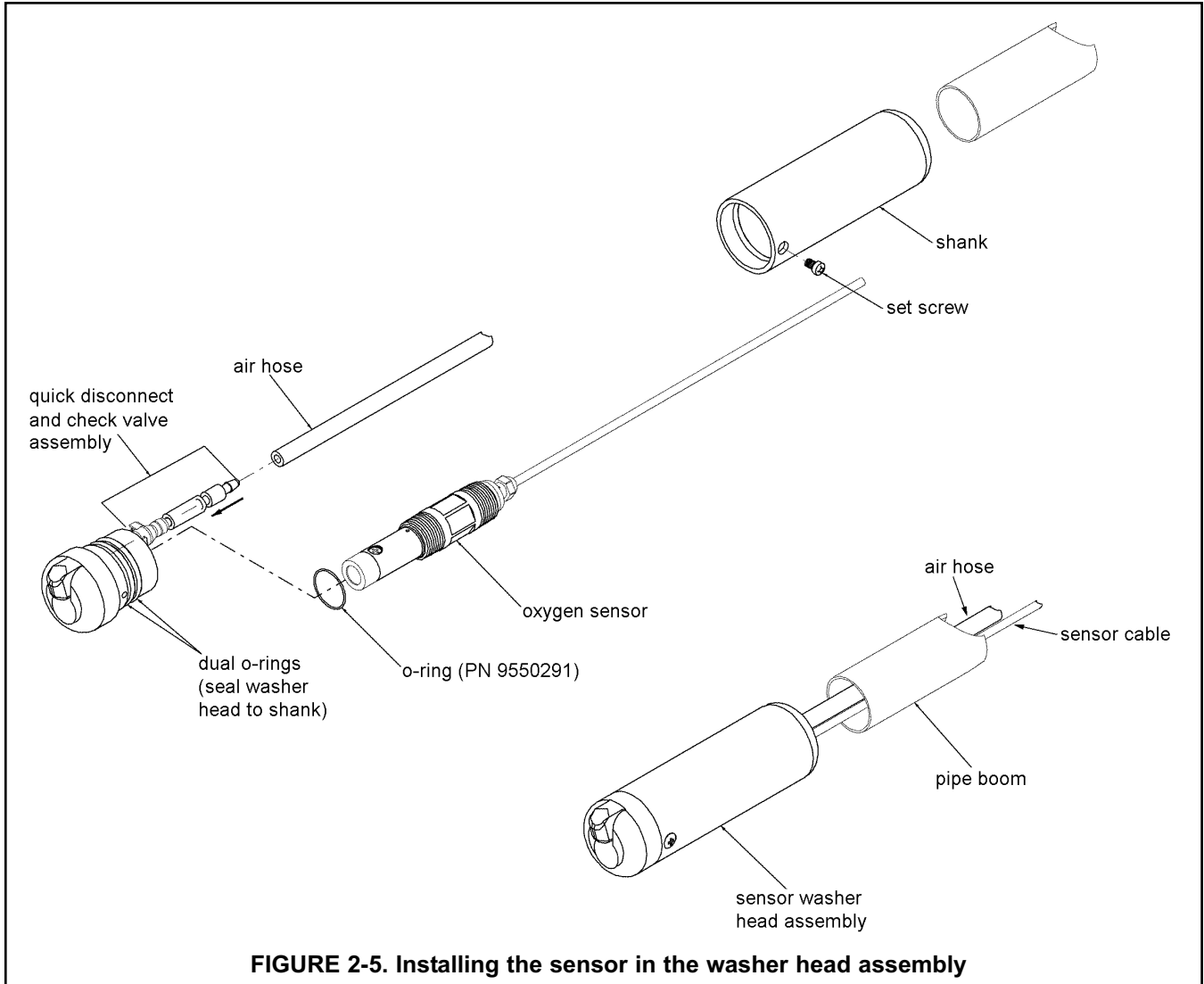

FIGURE 2-5. Installing the sensor in the washer head assembly

SECTION 3.0 WIRING

3.1 GENERAL

WARNING

Electrical installation must conform to the National Electrical Code, all state and local codes, and all plant codes and standards for electrical equipment. Electrical installation and wiring must be done by qualified personnel.

The five holes in the bottom of the Model 54eA enclosure accept 1/2-in. (PG-13.5) strain relief connectors or conduit fittings. The rear openings are for power and alarm relay wiring. The left front opening is for sensor wiring and the right front opening is for analog output wiring. Seal unused openings with conduit plugs.

3.2 POWER, ALARM, AND OUTPUT WIRING

Figure 3-1 shows the power, relay, and current output terminals. For access to the terminals, loosen the screw holding the protective cover in place and remove the cover. Make power and alarm connections on TB3. Make analog output wiring connections on TB2.

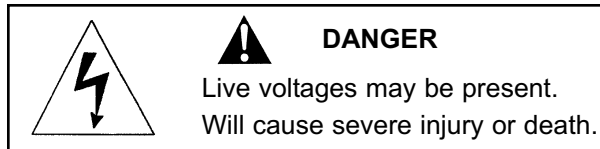

Alarm contacts are dry (i.e., not powered) and are normally open. Refer to Section 1.0 for relay specifications. Refer to Figure 3-2 or 3-3 for details on how to wire the Model ABSH (air blast system) to the 54eA analyzer. Figure 3-2 is for Model DO-03 (115 Vac 60 Hz). Figure 3-3 is for Model DO-04 (220 Vac 50 Hz).

NOTE

The 54eA analyzer has four alarm relays. Relays 1, 2, or 3 are normally open (NO) and can be used to operate the air blast cleaner. The wiring diagrams show alarm relay 3 being used. The relay used for the air blast cleaner **MUST** be configured as an interval timer. See Section 5.6 for programming details.

For best EMI/RFI protection, shield the output cable and enclose it in an earth-grounded, rigid, metal conduit. Connect the outer shield of the output cable to the earth ground connection on TB2 (see Figure 3-1).

Keep sensor and output signal wiring separate from power wiring. Do not run sensor and power cables in the same conduit or close together in a cable tray.

AC wiring must be 14 gauge or greater. Be sure to connect earth ground from the power cable to the nearby ground lug. A good earth ground is necessary for proper operation of the analyzer. Provide a switch or breaker to disconnect the analyzer from the main power supply. Install the switch or breaker near the analyzer and label it as the disconnecting device.

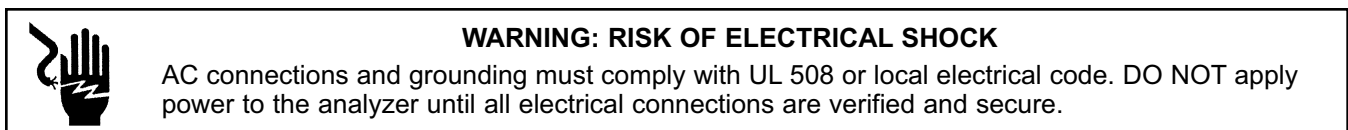

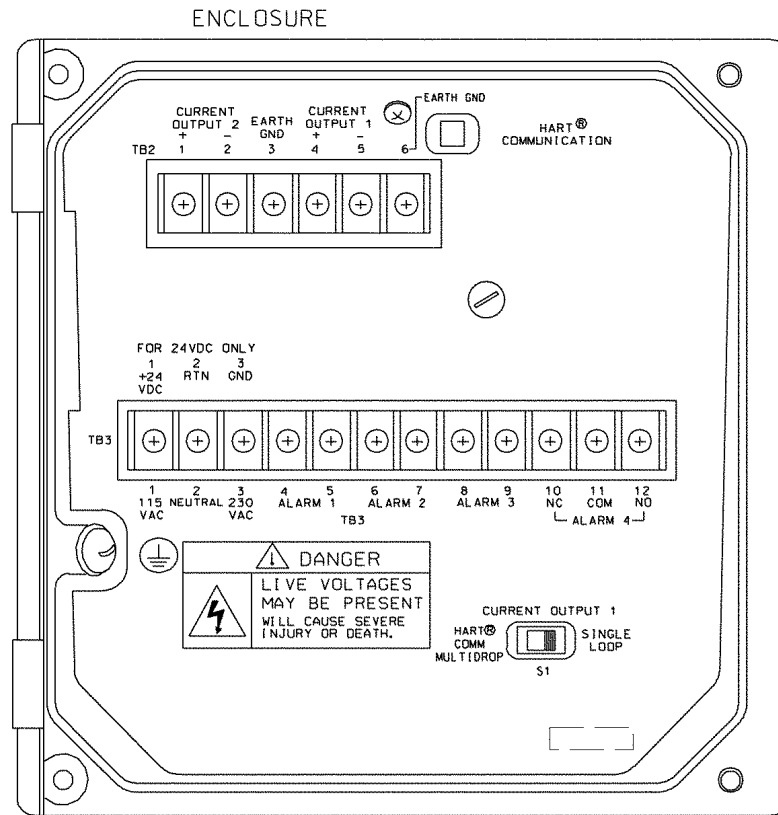

OUTPUT AND POWER WIRING

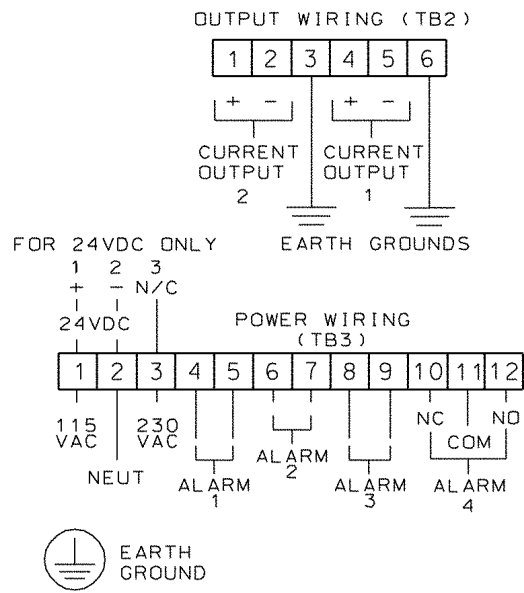

DWG. NO. 454EPH02	REV. D
----------------------	-----------

FIGURE 3-1. Power Input, Relay, and Output Wiring for 54eA analyzer

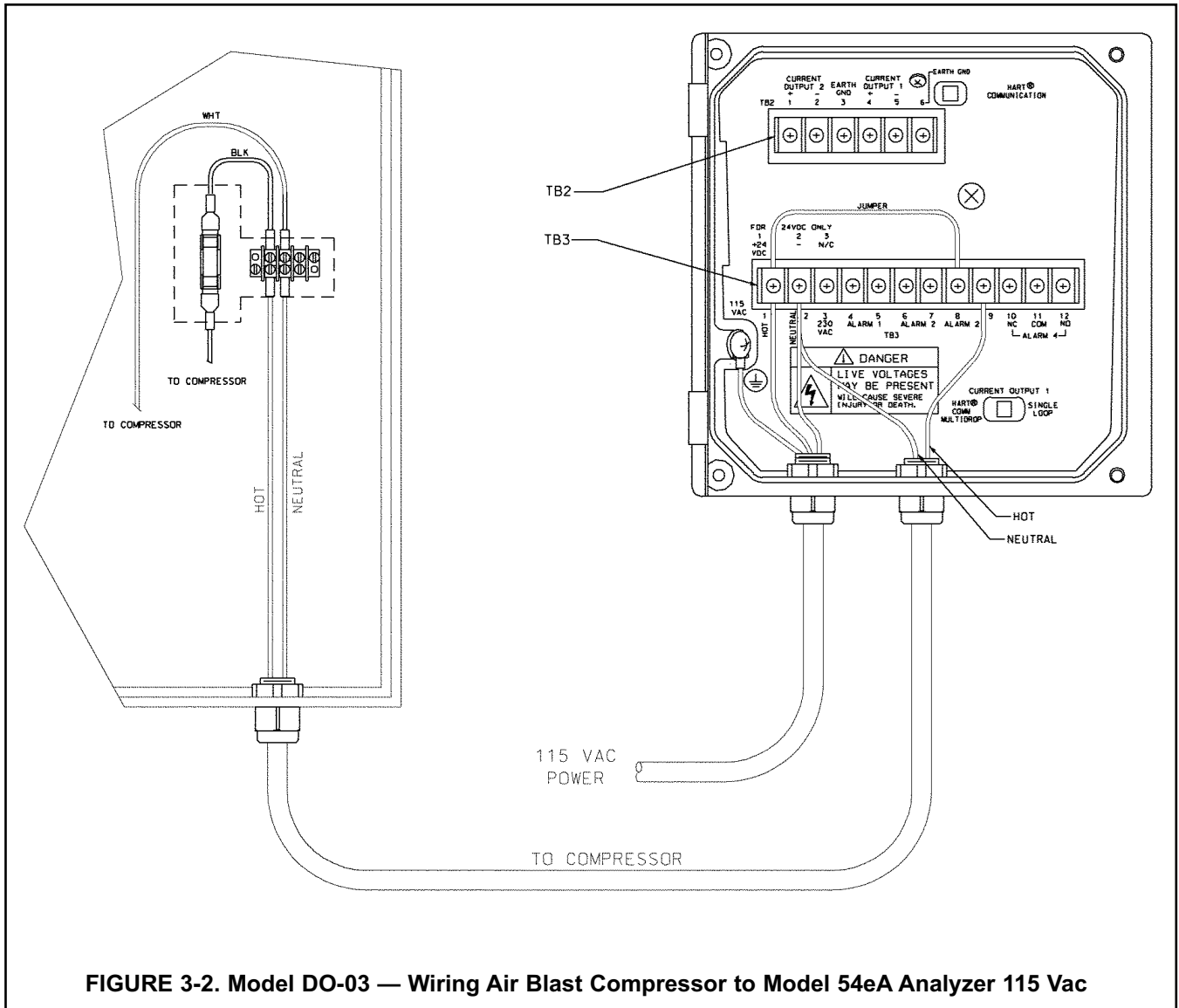

FIGURE 3-2. Model DO-03 — Wiring Air Blast Compressor to Model 54eA Analyzer 115 Vac

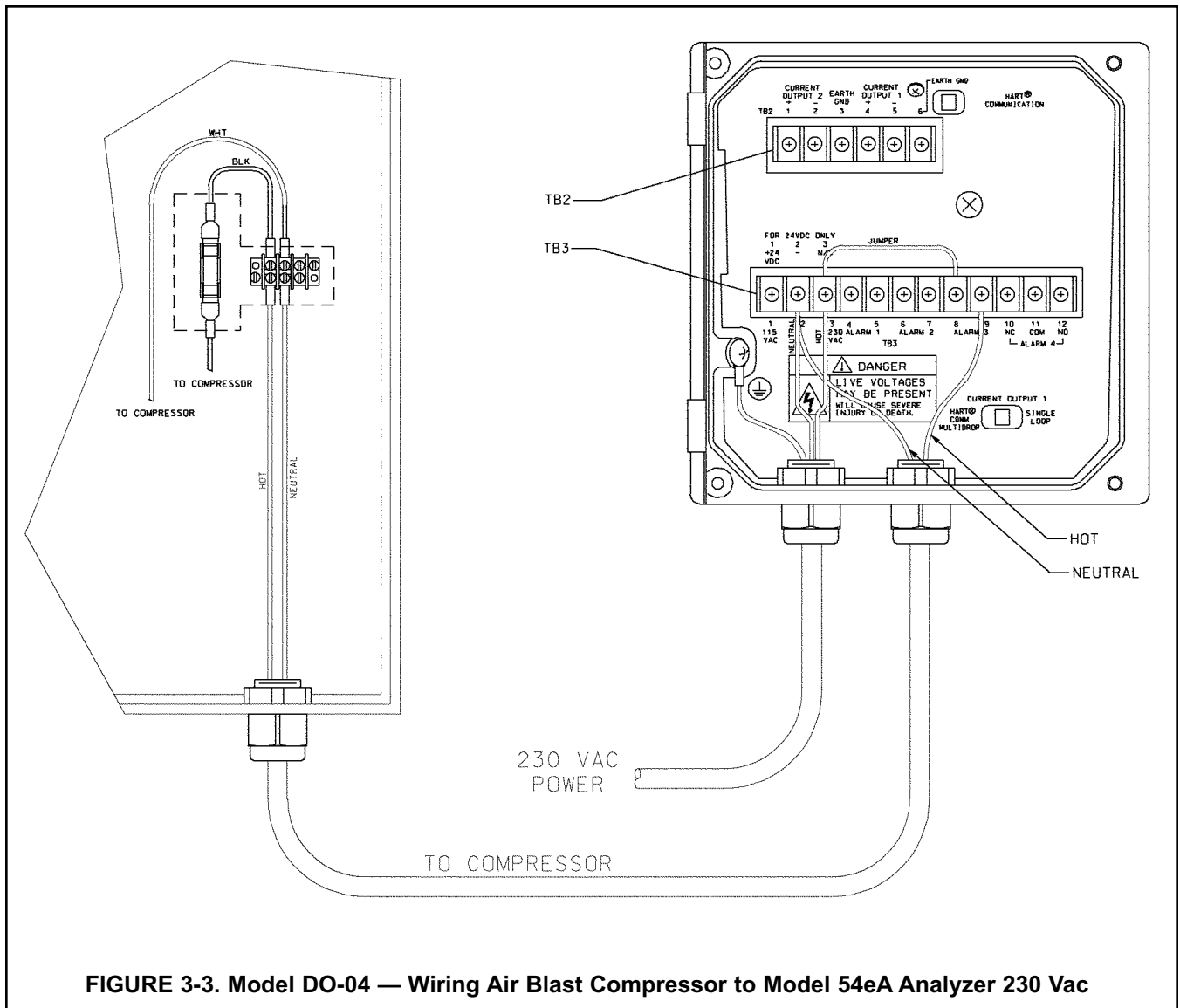

FIGURE 3-3. Model DO-04 — Wiring Air Blast Compressor to Model 54eA Analyzer 230 Vac

3.3 SENSOR WIRING

3.3.1 General

The wiring label, which is shown in Figure 3-4, is a general purpose label. It has wiring information concerning other sensors, for example, contacting conductivity and pH, that can be used with the 54eA instrument platform. For the measurement of oxygen only terminal strip TB3 is used.

3.3.2 Wiring the Oxygen Sensor

Figure 3-5 shows how to wire the oxygen sensor to the analyzer.

Although it is not standard with the Model DO-03/04, an optional quick disconnect (Variopol) sensor and cable are available. Figure 3-6 shows how to wire this sensor to the analyzer.

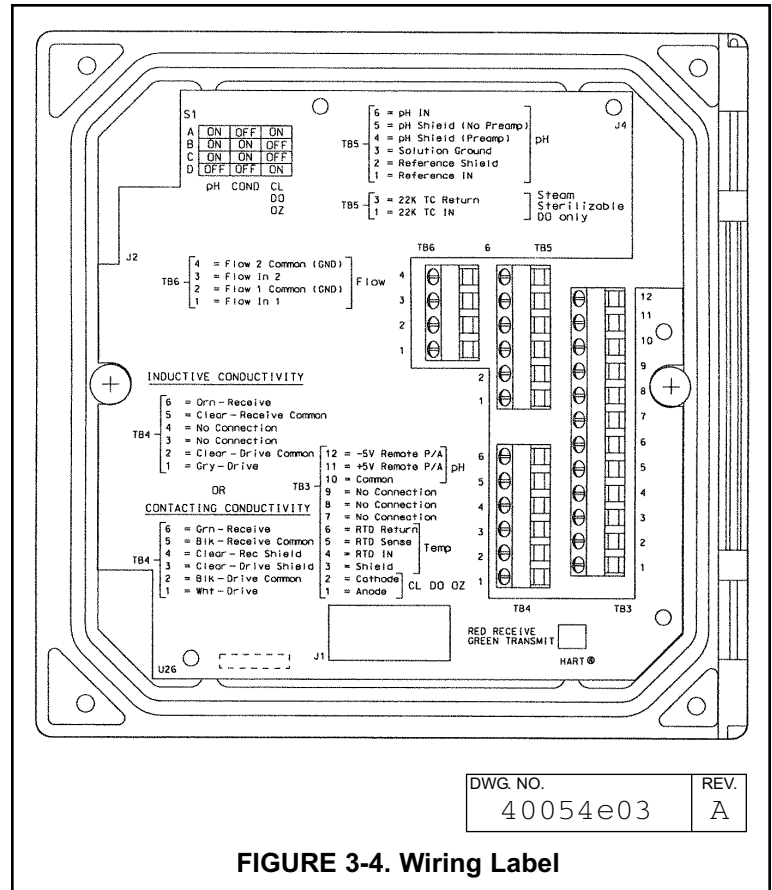

FIGURE 3-4. Wiring Label

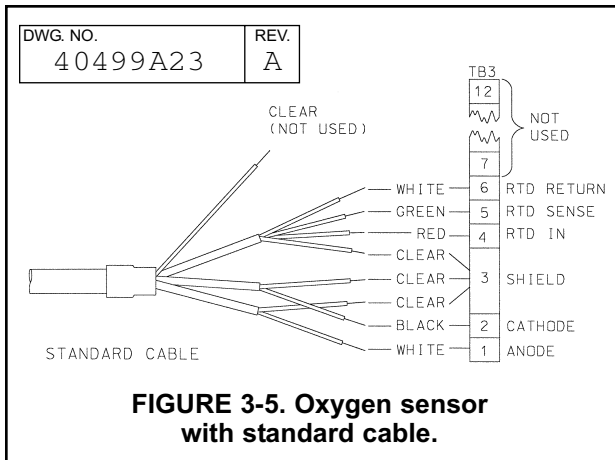

FIGURE 3-5. Oxygen sensor with standard cable.

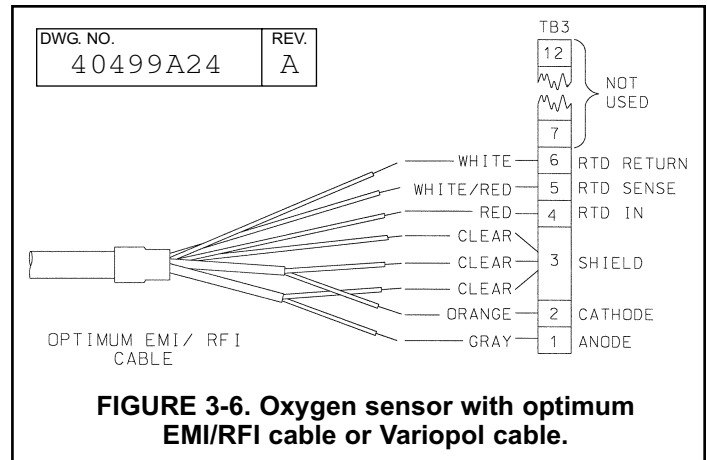
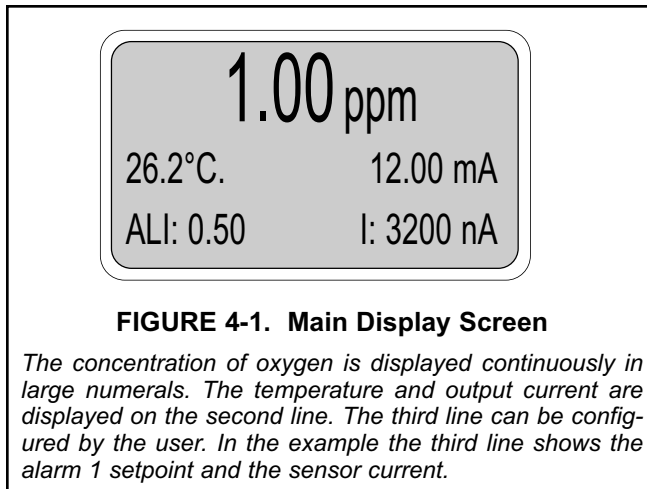

FIGURE 3-6. Oxygen sensor with optimum EMI/RFI cable or Variopol cable.

SECTION 4.0 DISPLAY AND OPERATION

4.1 DISPLAY

Figure 4-1 shows the main display.



4.2 KEY FUNCTIONS AND CONTROL

The keys labeled F1, F2, F3, and F4 are multi-function. The function appears in the main display just above the key. For example, F1 is usually labeled Exit and F4 may be labeled Edit, Save, or Enter.

1. To enter the main menu, press any key.
2. Use the \uparrow and \downarrow keys to move the cursor to the desired sub-menu. The position of the cursor is shown in reverse video.

NOTE

When the last item of a menu has been reached, the cursor will be on the third line of the display. If the cursor is on the second line of the display more items remain. Continue pressing the \downarrow key.

3. Press Enter (F4) to access a sub-menu or an item in a sub-menu.
4. To change a number or a setting press Edit (F4). The display will change to show the cursor on the first digit or on a + or - sign. Use the \uparrow and \downarrow keys to increase or decrease a digit or to toggle the + and - signs. Use the \leftarrow and \rightarrow keys to move the cursor left and right.
5. If an entire number or a word is highlighted, use the \uparrow and \downarrow keys to scroll through the list of choices.
6. To store a number or setting in memory, press Save (F4).
7. To leave without storing changes, press Esc (F3).
8. To leave and return to the previous screen, press Exit (F1).
9. To end a calibration step and leave the previous calibration in place, press Abort (F1).
10. Occasionally, information screens will appear. To leave the information screen and move to the next screen press Cont (F3).

4.3 ALARM STATUS

Green LEDs (labeled 1, 2, and 3) indicate when alarm relays 1, 2, and 3 are energized. The fourth relay indicates a fault condition. When a fault occurs, the red LED (labeled FAIL) lights up, a descriptive error message appears, and the outputs and alarm relays act as described in Section 5.5 and Section 5.6 under fault value.

The red LED also indicates when the interval timer routine is activated and when the time limit has been reached on a feed limit timer. For more information on these subjects, see Section 5.6.

SECTION 5.0 SOFTWARE CONFIGURATION

Figure 5-1 is an outline of the menu structure.

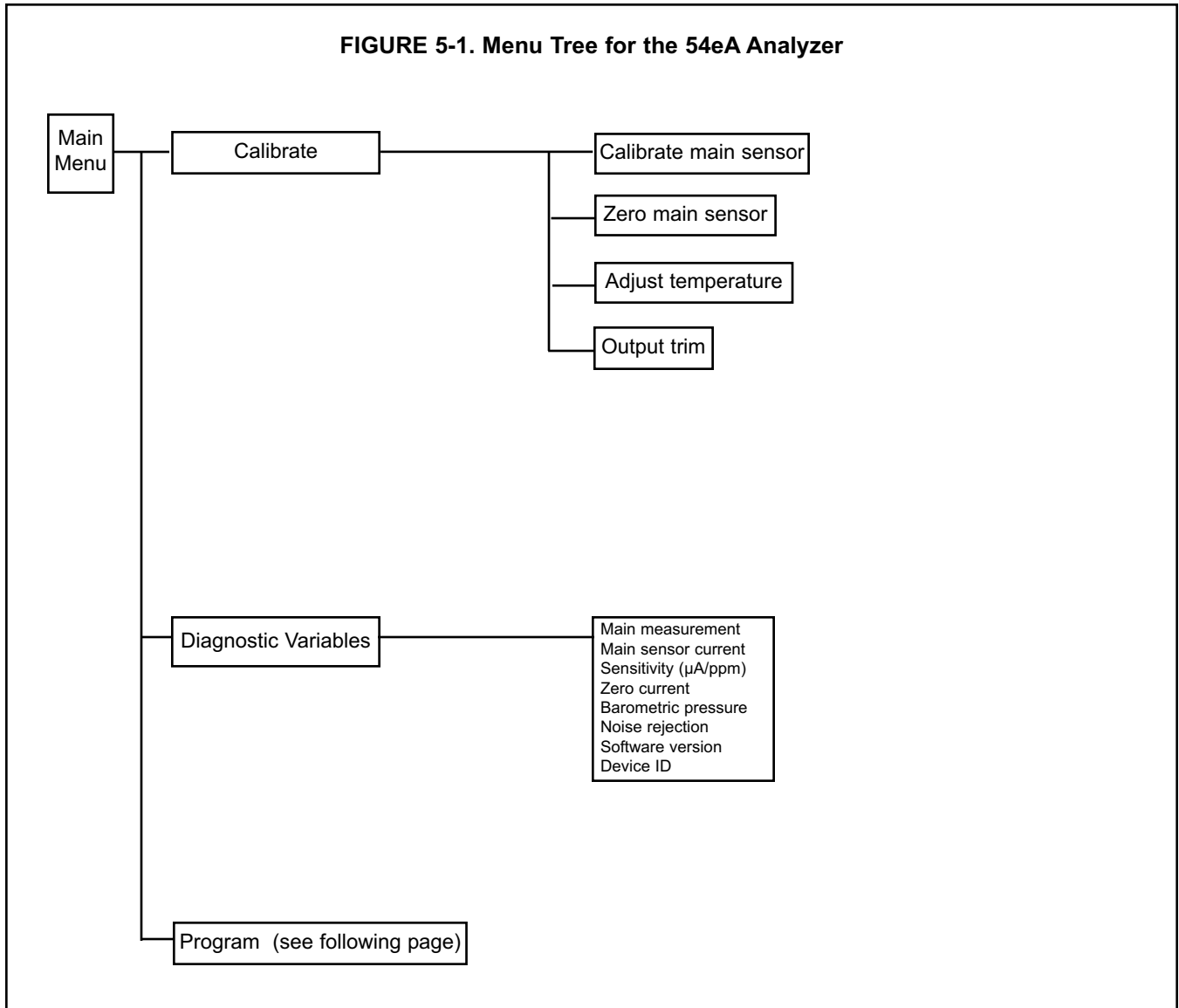

**FIGURE 5-1. Menu Tree for the 54eA Analyzer
(continued)**

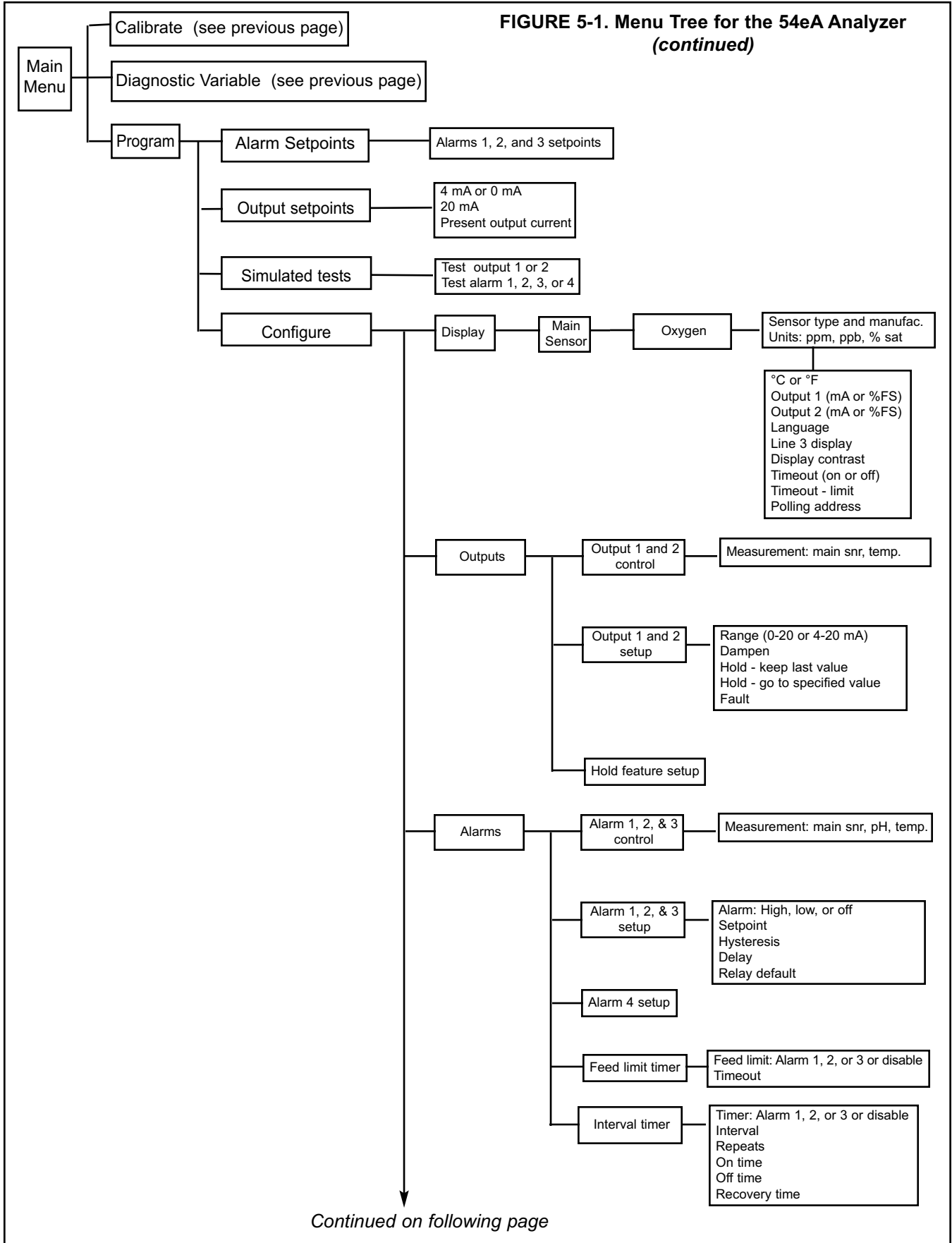

FIGURE 5-1. Menu Tree for the 54eA Analyzer (continued)

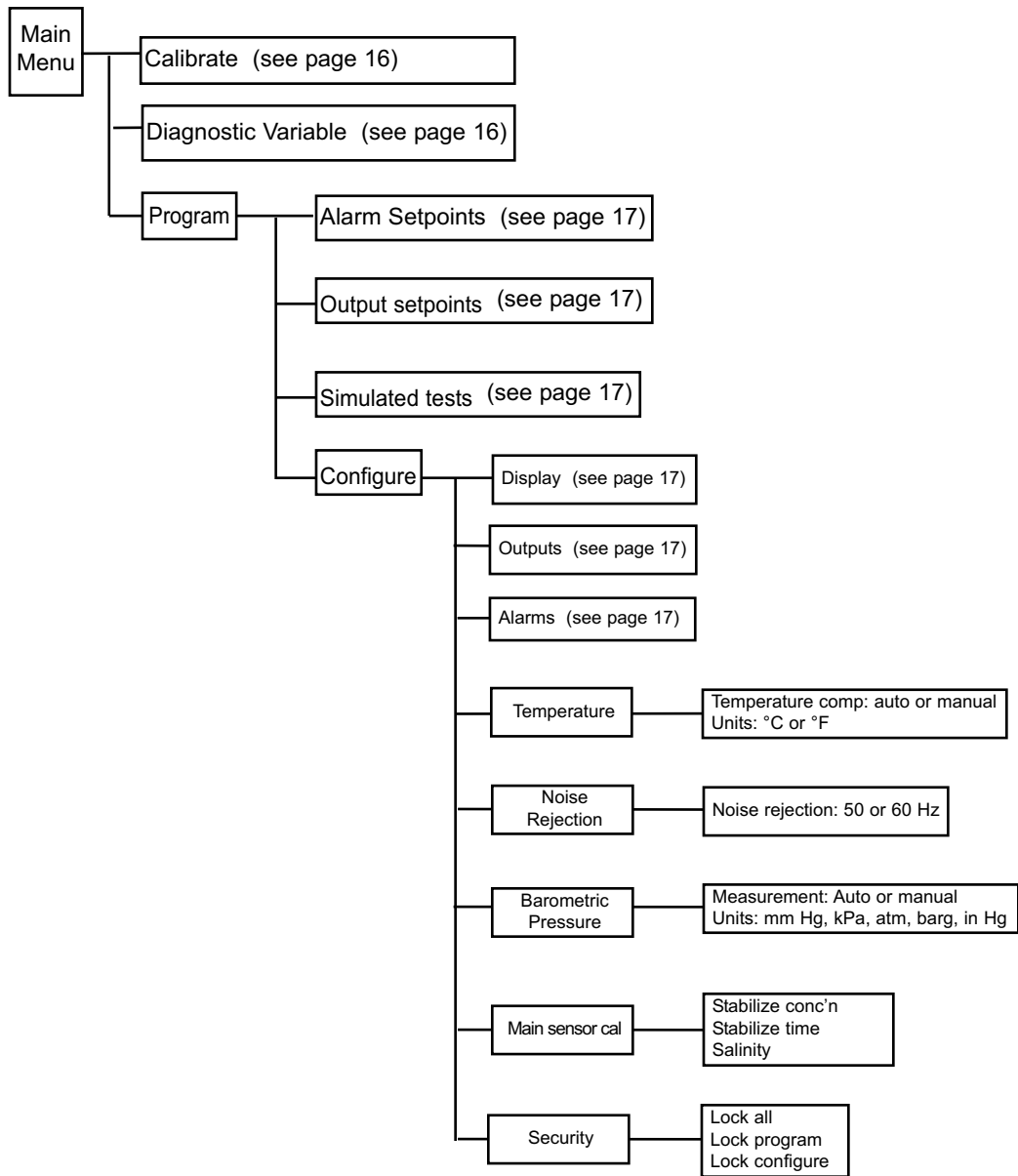

Table 5-1 lists the default settings and the range of choices available for each setting. To reduce the chance of error when configuring the analyzer the first time, enter settings in the order shown in the table.

TABLE 5-1. Program Settings List

ITEM	CHOICES	FACTORY SETTINGS
SETPOINTS		
A. Alarms (Section 5.1)		
1. Alarm 1 (low action)		
a. if oxygen (ppm)	-99 to 99 ppm	0 ppm
b. if oxygen (% saturation)	0 to 200%	0 %
c. if temperature	-5 to 130°C	0.1°C
2. Alarm 2 (high action)		
a. if oxygen (ppm)	-99 to 99 ppm	20 ppm
b. if oxygen (% saturation)	0 to 200%	200 %
c. if temperature	-5 to 130°C	130°C
3. Alarm 3	See alarm 2	See alarm 2
B. Outputs (Section 5.2 and 5.3)		
1. Output 1 or 2: 4 mA setting		
a. if oxygen (ppm)	-99 to 99 ppm	0 ppm
b. if oxygen (% saturation)	0 to 200%	0 %
c. if temperature	-5 to 130°C	0.1°C
2. Output 1 or 2: 20 mA setting		
a. if oxygen (ppm)	-99 to 99 ppm	20 ppm
b. if oxygen (% saturation)	0 to 200%	200%
c. if temperature	-5 to 130°C	130°C
CONFIGURE		
A. Display options (Section 5.4)		
1. Measurement	Oxygen, ozone, free chlorine, total chlorine	Oxygen
2. Sensor (Oxygen only)	Rosemount standard, Rosemount biopharm, or other steam sterilizable	Rosemount standard
3. Units (Oxygen only)	ppm, ppb, % saturation	ppm
4. Temperature units	°C or °F	°C
5. Output 1	mA or % of full scale	mA
6. Output 2	mA or % of full scale	mA
7. Language	English, Français, Español, Deutsch, Italiano	English
8. Main display left	See section 5.5	Sensor current
9. Main display right	See section 5.5	Output 1 current
10. Display contrast	00-99 (darkest)	50
11. Test timeout	On or off	On
12. Timeout value	1 to 60 min	10 min

Continued on the following page

TABLE 5-1. Program Settings List (continued)

ITEM CONFIGURE	CHOICES	FACTORY SETTINGS
B Outputs (Section 5.5)		
1. Output 1		
a. Measurement	Oxygen or temperature	Oxygen
b. Control	Normal	Normal
2. Output 1 Setup		
a. Current	4-20 mA or 0-20 mA	4-20 mA
b. Dampening	0-299 sec	0 sec
c. Hold mode	Hold last value or go to fixed value	Hold last value
d. Fixed hold value	0-22 mA	21 mA
e. Fault value	0-22 mA	22 mA
3. Output 2		
a. Measurement	Oxygen or temperature	Temperature
b. Control	Normal	Normal
4. Output 2 Setup	See output 1	See output 1
5. Hold feature	Enable, disable, or 20 min timeout	Disable
C. Alarms (Section 5.6)		
1. Alarm 1		
a. Activation method	Oxygen or temperature	Oxygen
b. Control mode	Normal	Normal
2. Alarm 1 setup		
a. Configuration	Low, high, or off	High
b. Hysteresis		
if oxygen (ppm)	0 to 20 ppm	0 ppm
if oxygen (ppb)	0 to 999 ppb	0 ppb
if oxygen (% saturation)	0 to 200%	0%
if temperature	0 to 10°C	0.1°C
c. Delay time	0-99 sec	0 sec
d. Relay fault	none, open, closed	None
3. Alarm 2		
a. Activation method	Oxygen or temperature	Oxygen
b. Control mode	Normal	Normal
4. Alarm 2 setup		
a. Configuration	Low, high, or off	Low
Rest of alarm 2 setup is the same as alarm 1		
5. Alarm 3 setup is the same as alarm 1		
6. Alarm 4		
Alarm	Fault or off	Fault
7. Feed limit timer		
a. Feed limit	Disable, alarm 1, alarm 2, or alarm 3	Disable
b. Timeout value	0 to 10,800 sec	600 sec
8. Interval timer		
a. Select alarm	Disable, alarm 1, alarm 2, or alarm 3	Disable
b. Interval time	0 to 999.9 hr	24.0 hr
c. Repeats	1 to 60	1
d. On time	0 to 2999 sec	120 sec
e. Off time	0 to 2999 sec	1 sec
f. Recovery time	0 to 999 sec	600 sec

TABLE 5-1. Program Settings List (continued)

ITEM	CHOICES	FACTORY SETTINGS
CONFIGURE (continued)		
D. Temperature compensation (Section 5.7)		
1. Temperature compensation	Auto or manual	Auto
2. Manual temperature	-15 to 130°C	25°C
E. Noise Reduction (section 5.8)		
Noise rejection	50 or 60 Hz	60 Hz
F. Barometric Pressure (Section 5.9)		
1. Barometric pressure	Auto or manual	Auto
2. Barometric pressure manual	0.4 - 1.2 atm (or equivalent units)	1.00 atm
3. Barometric pressure units	mm Hg, in Hg, bar, kPa	mm Hg
G. Main sensor calibration (Section 5.10)		
1. Stabilize reading		
a. oxygen (ppm)	0 to 20 ppm	0.05 ppm
b. oxygen (% saturation)	0 to 200%	1%
2. Stabilize time	0 - 30 sec	10 sec
3. Sensor zero stabilization value		
4. Salinity (parts per thousand)	0.0 - 99.9 ‰	0.0 ‰
H. Security (Section 5.11)		
1. Lock all	000-999 (000 disables)	000
2. Lock program	000-999 (000 disables)	000
3. Lock configuration	000-999 (000 disables)	000

5.1 CHANGING ALARM SETPOINTS

1. Before changing alarm setpoints, be sure that alarms are properly configured. See Section 5.6.

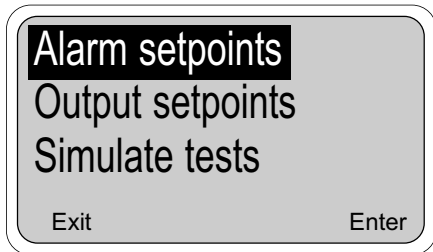

2. Press any key to enter the main menu. Move the cursor to "Program" and press Enter (F4).

3. Press Enter (F4).

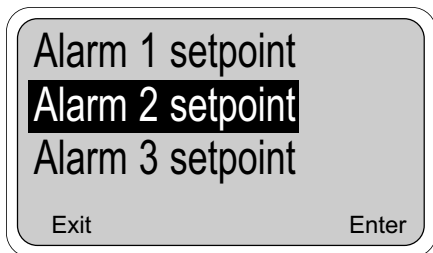

4. Move the cursor to the desired alarm and press Enter (F4).

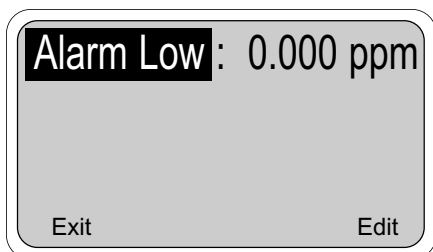

5. A screen like the one shown will appear. The alarm is a low alarm and the setpoint is 0.00 ppm. Press Edit (F4). Use the arrow keys to change the setpoint. Press Save (F4) to store the new value. Press Exit (F1) to return to the screen in step 4. Choose a new alarm.

5.2 RANGING THE OUTPUTS

1. Ranging the outputs means assigning values to the low (0 or 4 mA) and high (20 mA) outputs. **Before ranging the outputs, be sure the outputs are properly configured. See Section 5.5.**

2. Press any key to enter the main menu. Move the cursor to "Program" and press Enter (F4).

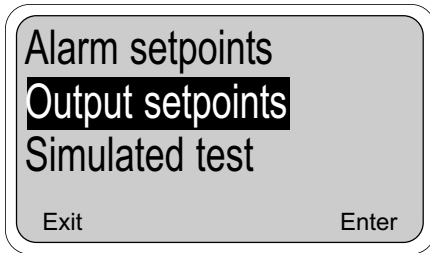

3. Move the cursor to "Output setpoints" and press Enter (F4).

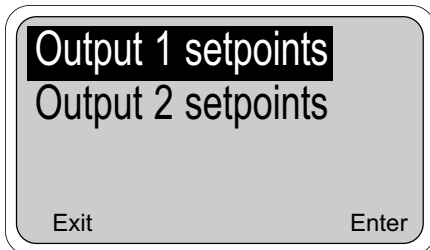

4. Move the cursor to the desired output and press Enter (F4).

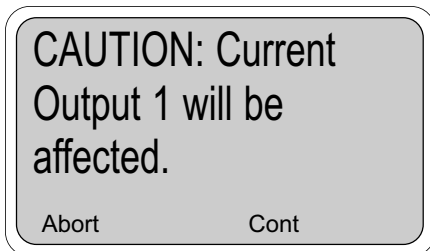

5. This screen confirms that changes to output 1 are going to be made. Press Cont (F3) to continue. Otherwise, press Abort (F1).

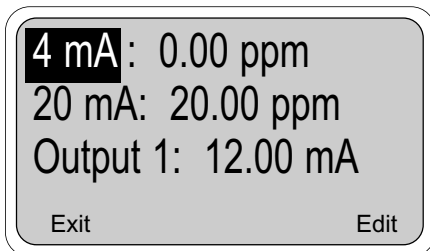

6. This screen shows the present settings for Output 1. If the output was configured to be 0-20 mA, the first line will show "0mA" instead of "4mA". The live current output is shown on the third line.

Move the cursor to the desired line and press Edit (F4). Use the arrow keys to change the setpoint. Press Save (F4) to store the new value.

Press Exit (F1) to return to the screen in step 4. Choose the other output and continue.

5.3 TESTING OUTPUTS AND ALARMS

- For testing purposes, the analyzer can be programmed to generate simulated outputs and to activate and deactivate alarms.

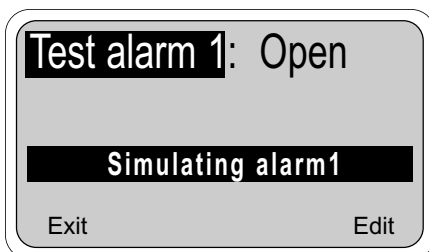
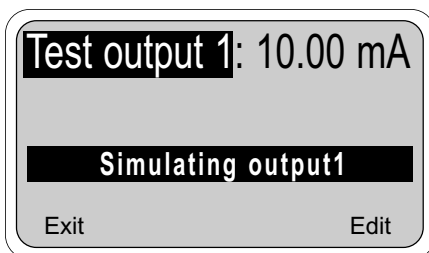
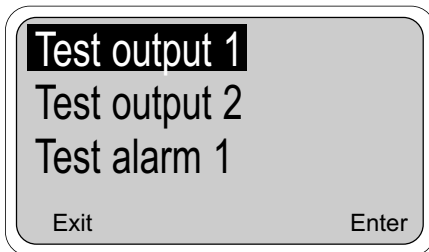
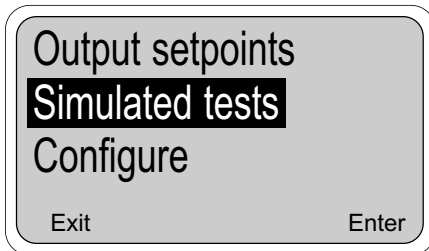

- Press any key to enter the main menu. Move the cursor to "Program" and press Enter (F4).

- Move the cursor to "Simulated tests" and press Enter (F4).

- Move the cursor to the desired output or alarm. Both outputs and all four alarms can be tested. Press Enter (F4).

A screen will appear warning that the output or alarm will change. Press Cont (F3) to continue. Press Abort (F1) to cancel the simulation.

- This screen appears when an output is being simulated. To change the simulation current, press Edit (F4). Use the arrow keys to change the current to the desired value. Press Test (F4), then Esc (F3).

The simulated current will be generated for 10 minutes, then the output returns to normal operation. To change the timeout to a different value see Section 5.4.

To end the simulation at any time, press Exit (F1).

- This screen appears when an alarm is being simulated. To change the state of the relay, press Edit (F4). Use the \uparrow or \downarrow keys to change from open to closed. Press Test (F4), then Esc (F3).

The alarm will be simulated for 10 minutes, then the alarm returns to normal operation. To change the timeout to a different value, see Section 5.4.

To end the simulation at any time, press Exit (F1).

5.4 CHOOSING DISPLAY OPTIONS

1. The 54eA analyzer can be used with other oxygen sensors manufactured by Rosemount Analytical as well as with chlorine, monochloramine, and ozone sensors. The user must configure the analyzer to match the sensor being used.
2. The display menu also lets the user customize the third line in the display, change timeout values, choose a language other than English, and change the display contrast.
3. Press any key to enter the main menu. Move the cursor to "Program" and press Enter (F4).

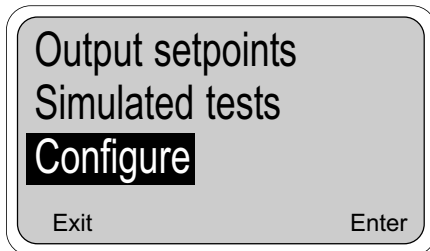

4. Move the cursor to "Configure" and press Enter (F4).

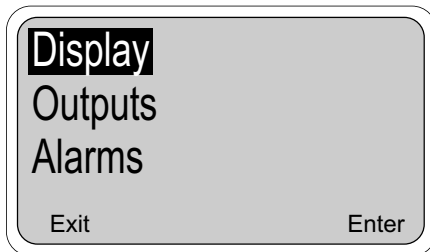

5. With the cursor on "Display", press Enter (F4).

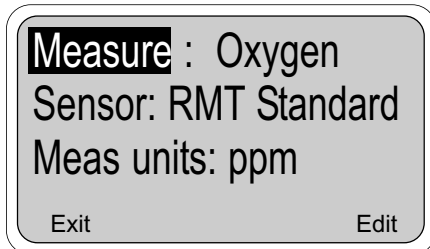

6. The screen at left appears. The default settings shown for "Measure" (Oxygen) and "Sensor" (RMT Standard) are appropriate for the 499ADO sensor. There are no changes to make.

If you wish to change the units, use the ↓ key to move the cursor to "Meas units" and press Edit (F4). Use the ↑ or ↓ keys to scroll through the choices. Press Save (F4) to store the selection.

5.4 CHOOSING DISPLAY OPTIONS (CONTINUED)

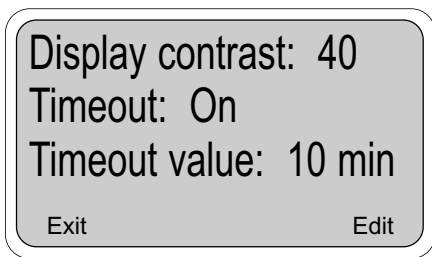
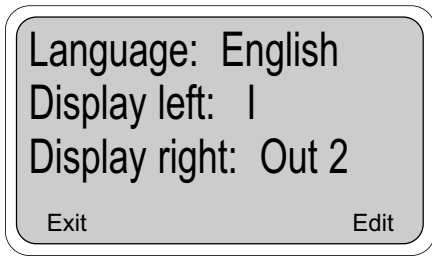
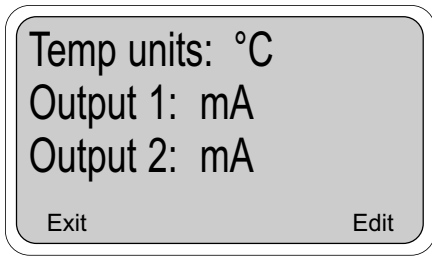

7. Set the remainder of the display parameters. Use the **↑** and **↓** keys to choose the desired parameter. Then press Edit (F4). Use the **↑** key to move the cursor to the desired selection. Press Save (F4) to store.

Temp units	°C or °F
Output 1	mA or % of full scale
Output 2	mA or % of full scale
Language	English, Français, Español, Deutsch, Italiano
Display left	sensor current (I), alarm 1 setpoint (no units), alarm 3 setpoint (no units), or blank
Display right	sensor current (I), alarm 2 setpoint (no units), alarm 3 setpoint (no units), output 2, or blank
Display Contrast	00 (lightest)-99 (darkest); the display contrast changes as the number changes
Timeout	Timeout returns the display from any other screen to the main display if no key is pressed before the timeout value is exceeded.
Timeout value	
Polling address	Identifies analyzer in multi-drop HART applications.

SECURITY CAUTION

The analyzer uses the timeout value to activate security. Once the analyzer is unlocked by entering a security code, security will not re-activate until a display timeout occurs. If timeout has been turned off, security will never reactivate.

5.5 CHANGING OUTPUT PARAMETERS

1. This section describes how to configure the analyzer outputs. Outputs can be configured to represent dissolved oxygen or temperature.

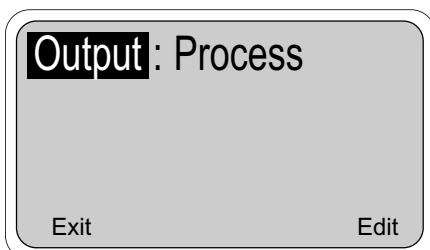
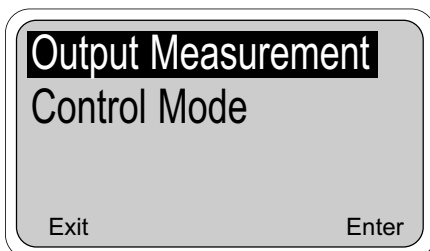
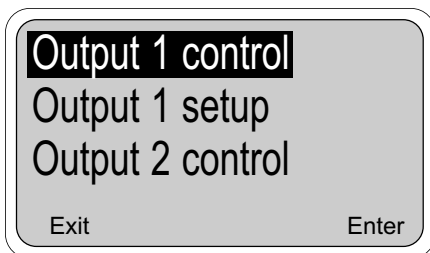
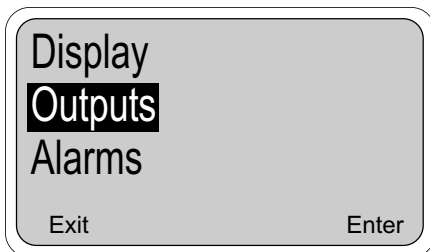
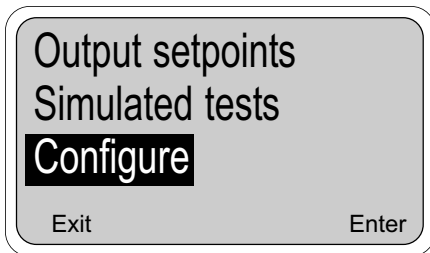

2. Press any key to enter the main menu. Move the cursor to "Program" and press Enter (F4).

3. Move the cursor to "Configure" and press Enter (F4).

4. Move the cursor to "Outputs" and press Enter (F4).

5. Five menu headers relate to outputs. Each output has a control header and a setup header. The fifth header allows the output hold feature to be configured.

NOTE

The 54eA analyzer can be ordered with optional PID control feature. The version of the 54eA analyzer provided with the DO-03/04 does not have control. Although the control header appears in this screen, it is not activated.

To access a header, move the cursor to the desired header and press Enter (F4).

6. **Output Control Settings:**

- a. Move the cursor to the desired output control header. Press Enter (F4).

- b. With the cursor on "Output Measurement" press Enter (F4).

- c. Press Edit (F4).

- d. Use the \uparrow key to scroll through the choices: "Process" and "Temperature". "Process" means dissolved oxygen. Press Save (F4) to store the selection.

- e. The display returns to the "Output: Process" screen. Press Exit (F1) until the screen in Step 5 appears.

5.5 CHANGING OUTPUT PARAMETERS (continued)

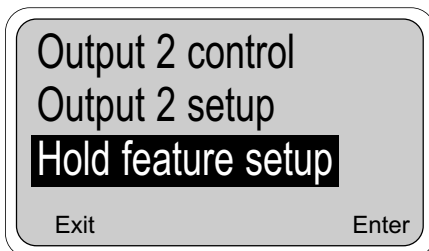
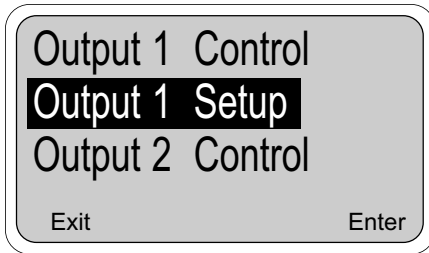

7. Output setup for normal outputs:

- a. Move the cursor to the desired output setup and press Enter (F4).

- b. Use the \uparrow and \downarrow arrow keys to move the cursor to the desired parameter. Press Edit (F4). Use the arrow keys to change the setting to the desired value and press Save(F4) to store the value.

Range: Choose 4-20 mA or 0-20 mA.

Dampen: Dampening averages the output current, thus smoothing out a noisy reading. Higher values provide more smoothing but increase the response time of the output.

Hold and Fixed Hold: If the analyzer is placed in hold, the outputs will either remain at the last value or go to a fixed value selected by the user. The fixed value must be between 0 and 22.00 mA.

Fault: If the analyzer detects a fault, the output will signal the fault by going to a user-selected current between 0 and 22.00 mA.

For allowed values, see Table 5-1.

8. Hold setup.

- a. Move the cursor to "Hold feature setup" and press Enter (F4).
- b. Press Edit (F4). Use the \uparrow to scroll through the choices: "Disable feature", "Enable feature", and "20 min timeout". If "20 min timeout" is selected, hold mode will automatically disengage after being on for 20 minutes.

NOTE

Selecting "Enable hold" or "20-min timeout" does not put the analyzer in hold. It only allows the user to put the analyzer in hold when the analyzer is in calibrate mode.

9. Using hold.

If hold was enabled in step 8 above, the hold screen will appear as soon as the user enters the Calibrate menu. To activate Hold, press Edit (F4). Use the \uparrow key to change Off to On and press Save (F4). "Hold Mode Activated" will be displayed. Outputs and relays will go to the values programmed in step 7b.

"Hold Mode Activated" will continue to flash in the main display even after the user has left the Calibrate menu. To deactivate hold, enter the Calibrate menu and press Edit (F4). Use the \uparrow key to change On to Off and press Save (F4). Press Exit (F1) twice to return to the main display.

5.6 CHANGING ALARM PARAMETERS

1. This section describes how to configure the analyzer alarms. Alarms 1, 2, and 3 can be assigned to dissolved oxygen or temperature. In addition, alarm 1, 2, or 3 can be configured as a feed limit timer or as an interval timer (see steps 10 and 11). Alarm 4 is always a fault alarm.

2. Press any key to enter the main menu. Move the cursor to "Program" and press Enter (F4).

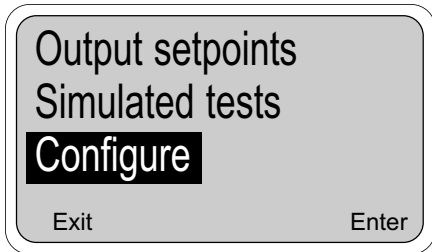

3. Move the cursor to "Configure" and press Enter (F4).

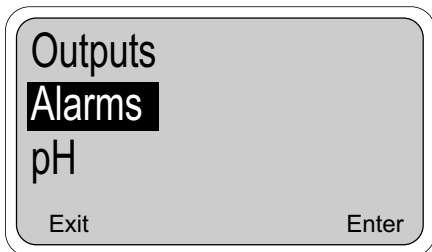

4. Move the cursor to "Alarms" and press Enter (F4).

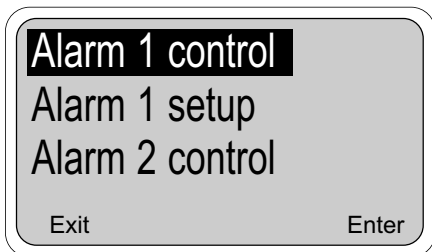

5. Nine menu headers relate to alarms. Alarms 1, 2 and 3, each have a control header and a setup header. Alarm 4 has only a setup header. The eighth menu header is for configuring the feed limit timer, and the ninth menu header is for configuring the interval timer.

NOTE

The 54eA analyzer can be ordered with optional TPC control feature. The version of the 54eA analyzer provided with the DO-03/04 does not have control. Although the control header appears in this screen, it is not activated.

To access a header, move the cursor to the desired header and press Enter (F4).

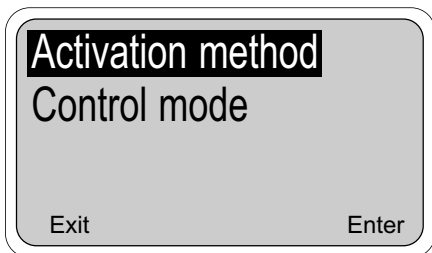

6. **Alarm Control Settings:**

a. Move the cursor to the desired output control header. Press Enter (F4).

b. With the cursor on "Activation method" press Enter (F4).

5.6 CHANGING ALARM PARAMETERS (continued)

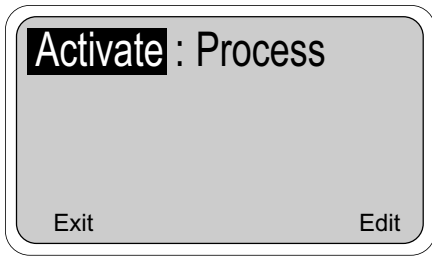

- c. To change the activation method, press Edit (F4). Use the ↑ key to scroll through the choices, "Process" or "Temperature". "Process" means dissolved oxygen. Press Save (F4) to store the selection.
- d. The display returns to the "Activate: Process" screen. Press Exit (F1) until the screen in Step 5 appears.

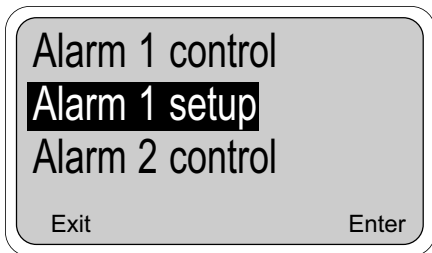

8. Alarm setup for normal alarms:

- a. Move the cursor to the desired alarm setup and press Enter (F4).

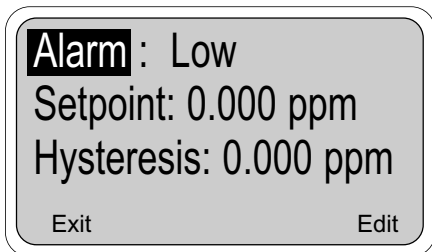

- b. Use the ↑ and ↓ keys to move the cursor to the desired parameter. Press Edit (F4). Use the arrow keys to change the setting to the desired value and press Save (F4) to store the value. See the Figures 5-2 and 5-3 for an explanation of terms: **low alarm**, **high alarm**, **hysteresis**, and **delay**. See Table 5-1 for allowed values and limits.

Relay default determines how the relay will operate if there is a fault or the analyzer is in hold. Alarms can be forced on (Close), off (Open), or remain unchanged (None).

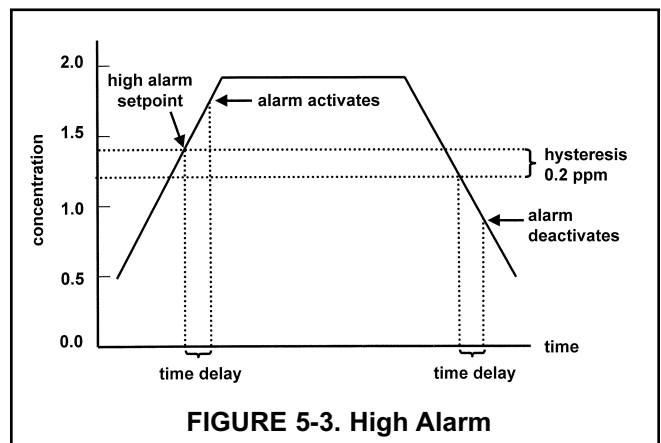
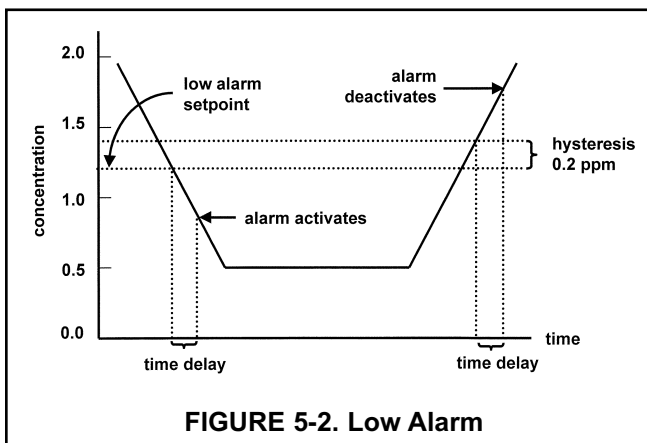

5.6 CHANGING ALARM PARAMETERS (continued)

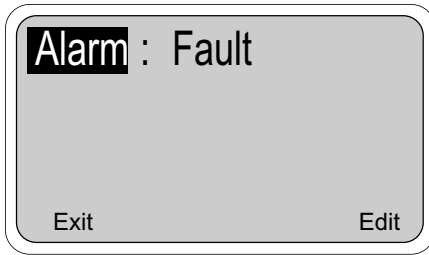

9. Alarm 4 setup:

Alarm 4 is a dedicated fault alarm. When a fault condition exists, the red LED on the front display will light.

- From the menu header screen (step 6) move the cursor to "Alarm 4 setup."
- To disable the alarm, press Edit (F4) and use the \uparrow key to change the "Fault" to "Off"

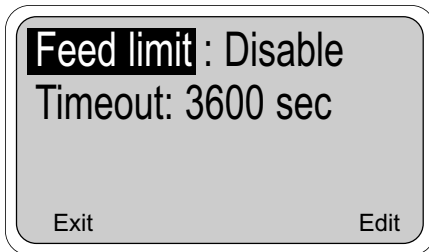

10. Feed limit timer setup:

Alarm 1, 2, or 3 can be configured as a feed limit timer. The feed limit timer prevents overfeeding of treatment chemicals by automatically turning off the relay after a timeout period.

- From the menu header screen (step 6) move the cursor to "Feed limit timer." Press Enter (F4).
- With the cursor on "Feed limit" press Edit. Use the \uparrow key to scroll through the choices: disable, AL 1, AL 2, and AL 3. Press Save (F4) to store the selection.
- Move the cursor to "Timeout". Press Edit (F4) and use the arrow keys to change the timeout to the desired value. Press Save (F4) to store the setting.

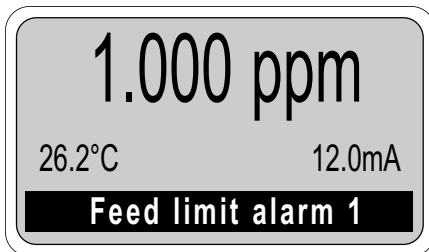

Operation of the feed limit timer. When a feed limit alarm has timed out, "Feed limit alarm 1" (if alarm 1 was chosen) appears in the display. At the same time the red FAIL LED will light and alarm 4 will close (if not turned off), and the selected feed limit relay (alarm 1) will open (de-energize). All other alarms and current outputs will remain unchanged. The relays remain in the state described until the Ack (F2) key is pressed, at which time the analyzer returns to normal operation and the feed limit clock starts again.

NOTE

Pressing Ack (F2) acknowledges all conditions that turn on the red LED. If another event occurs after F2 is pressed, F2 must be pressed again to acknowledge the new event.

5.6 CHANGING ALARM PARAMETERS (continued)

11. Interval timer setup:

Alarm 1, 2, or 3 can be used as an interval timer. The selected relay will open and close at time intervals programmed by the user. The interval timer is useful for automatic cleaning of sensors.

NOTE

The alarm relay used for the interval timer cannot be used for other purposes. When a timer sequence is occurring, both current outputs are placed in hold (even if hold was not enabled) and the other two alarms will be placed in their default states.

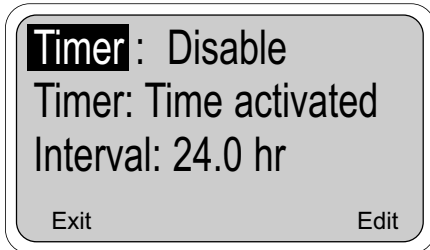
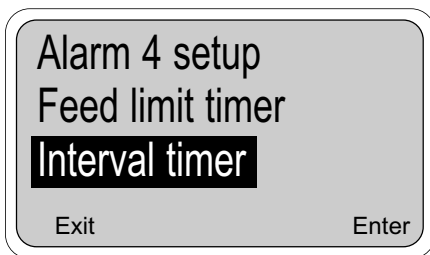

- a. From the menu header screen (step 6) move the cursor to "Interval timer."

- b. With the cursor on "Interval timer", press Enter (F4). Use the ↓ key to scroll through the selections. Use the arrow keys to change settings. Press Save (F4) to store.

Refer to the diagram for definition of terms: **interval**, **repeats**, **on time**, **off time**, and **recovery**.

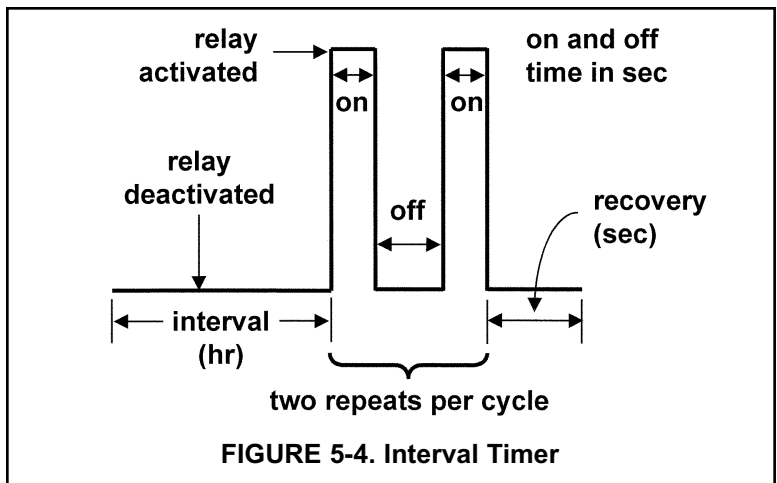

The user must determine the optimum cleaning frequency and duration. Operating the air blast cleaner for 60 seconds every eight (8) hours is a good starting point. Allow a 90-second recovery time.

5.7 TEMPERATURE COMPENSATION AND TEMPERATURE UNITS

1. Refer to Section 6.1 for a discussion of the ways in which temperature affects dissolved oxygen measurement.
2. Press any key to enter the main menu. Move the cursor to "Program" and press Enter (F4).
3. Move the cursor to "Configure" and press Enter (F4).
4. Move the cursor to "Temperature" and press Enter (F4).

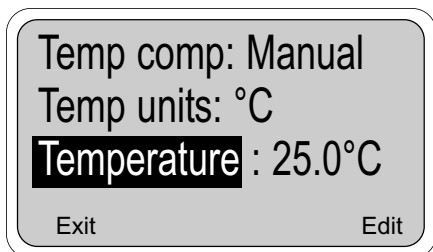
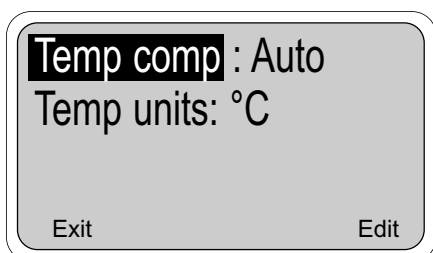
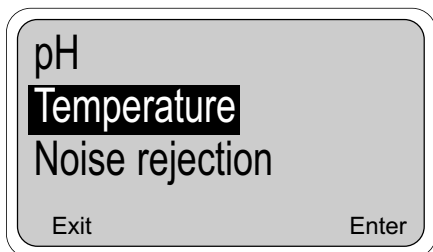

5. Use the \uparrow and \downarrow keys to move through the list of items. To make a change press Edit (F4). Use the arrow keys to change settings to the desired value. Press Save (F4) to store changes.

Auto: In automatic temperature compensation, the analyzer measures the temperature using an RTD (resistance temperature device) in the sensor. The analyzer then uses the measured temperature to calculate the membrane permeability correction and oxygen solubility factor.

Manual: In manual temperature compensation, the analyzer uses the temperature entered by the user to calculate the membrane permeability correction and oxygen solubility factor. It does **NOT** use the actual process temperature. Do **NOT** use manual temperature compensation unless the difference between the calibration and measurement temperatures is less than 2°C.

Manual temperature compensation is useful if the sensor RTD has failed and a replacement sensor is not available.

If Manual temperature compensation is selected, be sure to enter the desired temperature.

5.8 NOISE REDUCTION

1. For maximum noise reduction the frequency of the ac power must be entered into the analyzer.
2. Press any key to enter the main menu. Move the cursor to "Program" and press Enter (F4).
3. Move the cursor to "Configure" and press Enter (F4).
4. Move the cursor to "Noise rejection" and press Enter (F4).

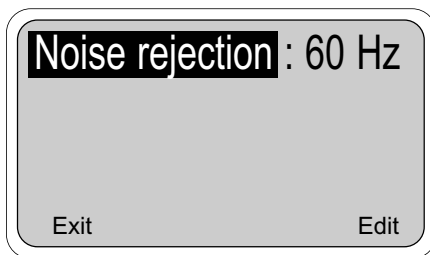
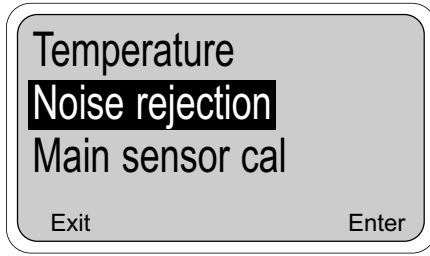

5. To change the frequency setting, press Edit (F4). Use the \uparrow key to toggle between 50 and 60 Hz. Press Save (F4) to store the change.

5.9 BAROMETRIC PRESSURE

1. Barometric pressure is used during air calibration.
2. Press any key to enter the main menu. Move the cursor to "Program" and press Enter (F4).
3. Move the cursor to "Configure" and press Enter (F4).
4. Move the cursor to "Barometric pressure" and press Enter (F4).

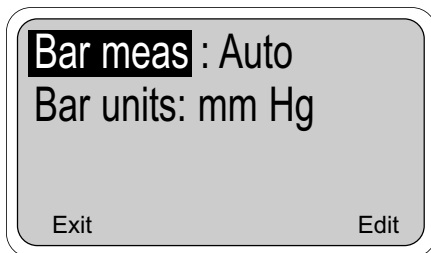
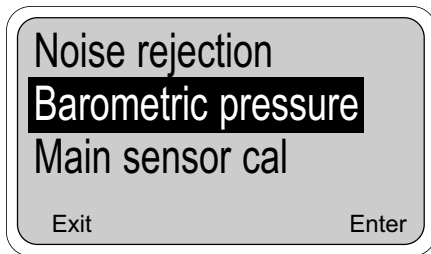

5. Use the ↑ and ↓ keys to move through the list of items. To make a change, press Edit (F4). Use the arrow keys to change settings to the desired value and press Save (F4).

Bar meas: The analyzer has an on-board sensor that automatically measures barometric pressure. To bypass the pressure sensor, select "Manual". Be sure to enter the desired pressure in the third line. During air calibration, the analyzer will use the barometric pressure entered in this step no matter what the true pressure is.

Bar units: Select the units in which barometric pressure will be displayed.

5.10 MAIN SENSOR CALIBRATION PARAMETERS

1. Main sensor refers to the dissolved oxygen sensor.
2. Press any key to enter the main menu. Move the cursor to "Program" and press Enter (F4).
3. Move the cursor to "Configure" and press Enter (F4).
4. Move the cursor to "Main sensor cal" and press Enter (F4).
5. Use the \uparrow and \downarrow keys to move through the list of items. To make a change press Edit (F4). Use the arrow keys to change settings to the desired value and press Save (F4). For allowed ranges, see Table 5-1.

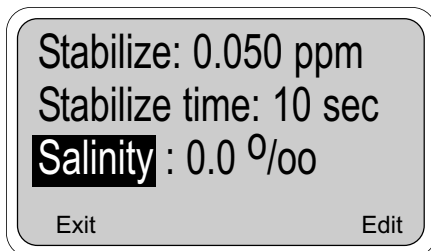
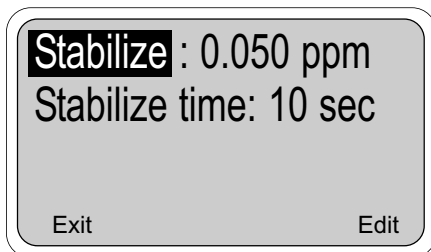
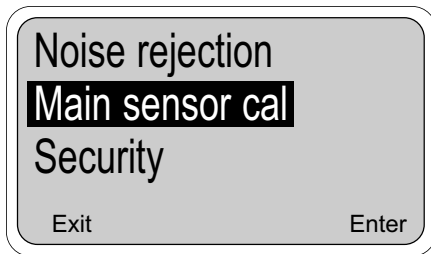

The choices depend on the measurement being made.

Stabilize and Stabilize time: For the analyzer to accept calibration data, the concentration must remain within a specified range for a specified period of time. The default values are 0.05 ppm and 10 seconds. Using a small stabilize value and a long stabilize time is the best protection against calibration while a reading is still changing.

Salinity: Salinity is used with oxygen measurements only. The solubility of oxygen in water depends on the concentration of dissolved salts in the water. Increasing the concentration decreases the solubility. If the salt concentration is greater than about 1000 ppm, the accuracy of the measurement can be improved by applying a salinity correction. Enter the salinity as parts per thousand (‰). One percent is ten parts per thousand.

5.11 SECURITY

- The analyzer can be programmed to require a password for access to menus. There are three levels:

Level 1: A level 1 user can

- Zero and calibrate the oxygen sensor
- Calibrate the barometric pressure sensor
- Change temperature compensation from automatic to manual and enter a manual compensation temperature
- View diagnostic variables.

Level 2: A level 2 user can

- Do everything a level 1 user can do
- Change alarm setpoints
- Rerange the 4-20 mA outputs
- Manually test both outputs and all four alarm relays.

Level 3: A level 3 user has access to every menu item. Only a level 3 user can change passwords.

A person with no password can only view the main display.

- Press any key to enter the main menu. Move the cursor to "Program" and press Enter (F4).

- Move the cursor to "Configure" and press Enter (F4).

- Move the cursor to "Security" and press Enter (F4).

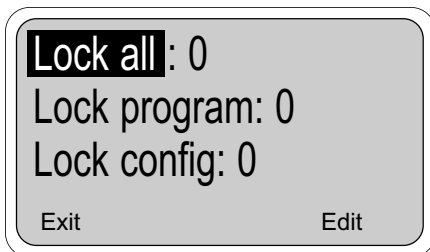
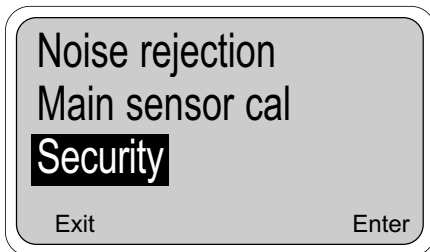

- Use the \uparrow and \downarrow keys to move through the list of items. To enter a password, press Edit (F4). Use the arrow keys to enter a three-digit password. Press Save (F4) to store the value.

Lock all: Until the user enters the "lock all" password, all he can do is view the main display. Entering the "lock all" password allows the user access to all Level 1 functions.

Lock program: Entering the "lock program" password allows the user access to all Level 2 functions.

Lock config: Entering the "lock config" password allows the user access to all Level 3 functions.

The analyzer will accept a higher level security code at a lower level security gate. For example, the analyzer will accept a level 2 password at a level 1 gate.

NOTES:

- A code of 000 disables security for that level.
- The security feature will not activate until after the timeout period has passed with no key presses.
- A hold condition will indefinitely prolong the timeout period.
- Security will activate immediately if power is removed and then restored.
- To recall a forgotten code, press and hold F4 for five seconds when the security screen appears. The code for that level will appear.

5.12 ANALYZER MODE PRIORITY

The Model 54eA analyzer can function in different modes depending on how it is configured, what process conditions exist, and actions an operator may have made. To reconcile these possible modes, there is a set priority that determines exactly what will happen to the two (2) current outputs and the four (4) alarm relays in the event of multiple modes occurring at the same time. See Table 5-2 below.

Priority is in the following order (from lowest to highest): normal, fault, timer, hold, feed limit, test. Each output or relay acts as if it is only in the state of highest priority.

NOTE

Some of these features may not be in use in the analyzer.

TABLE 5-2. Analyzer Mode Priority Chart

Condition	Priority	Current Output 1	Current Output 2	Alarm Relay 1	Alarm Relay 2	Alarm Relay 3	Alarm Relay 4
Normal	1	Normal	Normal	Normal	Normal	Normal	Open
Fault	2	Default	Default	Default	Default	Default	Closed
Interval Timer	3	Hold	Hold	Default/ Normal ¹	Default/ Normal ¹	Default/ Normal ¹	Prior
Hold Mode	4	Hold	Hold	Default	Default	Default	Prior
Feed Limit	5	Normal	Normal	Open ¹	Open ¹	Open ¹	Closed
Simulate tests	6	Test ¹	Test ¹	Test ¹	Test ¹	Test ¹	Test ¹

¹ Indicates the state **IF** that item has been configured or selected (i.e. if it is an interval timer or a feed limit timer or it is the one being tested). Unconfigured or unselected items are not affected by that mode.

Condition Definitions:

1. Normal refers to conditions when no other mode is present.
2. Fault means the instrument has diagnosed a fault condition. A fault message is displayed and the red LED is on.
3. Interval Timer means the timer sequence is occurring.
4. Hold Mode occurs when hold is activated by the operator (i.e. during calibration).
5. Feed Limit occurs when a feed limit timer has reached its limit and is turned off after being on for too long.
6. Simulate tests are described in Section 5.4.

Action Definitions:

1. Normal is determined by process conditions or how the item has been configured (Section 5.6)
2. Open is a deenergized alarm relay (alarm off).
3. Default is the setting configured for each item if there is a fault. (Section 5.6)
4. Closed is an energized alarm relay (alarm on).
5. Hold is the setting for the current output configured in Section 5.5 (fixed mA value or the last normal value).
6. Prior is the state the alarm had before that mode occurred.
7. Test is the value input by the operator (mA for current, on or off for a relay).

SECTION 6.0

CALIBRATION - TEMPERATURE

6.1 INTRODUCTION

The Model 499ADO sensor is a membrane-covered amperometric sensor. As the sensor operates, oxygen diffuses through the membrane and is consumed at an electrode immediately behind the membrane. The reaction produces a current that depends on the rate at which oxygen diffuses through the membrane. The diffusion rate, in turn, depends on the concentration of oxygen and how easily it passes through the membrane (the membrane permeability). Because the membrane permeability is a function of temperature, the sensor current will change if the temperature changes. To correct for changes in sensor current caused by temperature, the analyzer automatically applies a membrane permeability correction that converts the sensor current to the value at 25°C. The change is about 3%/°C at 25°C, so a 1°C error in temperature produces about a 3% error in the reading.

Temperature plays an additional role in oxygen measurements. Oxygen sensors are calibrated by exposing them to water-saturated air, which, from the point of view of the sensor, is equivalent to water saturated with atmospheric oxygen (see Section 7.0 for more information). During calibration, the analyzer calculates the solubility of atmospheric oxygen in water using the following steps. First, the analyzer measures the temperature. From the temperature, the analyzer calculates the vapor pressure of water and, using the barometric pressure, calculates the partial pressure of atmospheric oxygen. Once the analyzer knows the partial pressure, it calculates the equilibrium solubility of oxygen in water using a temperature-dependent factor called the Bunsen coefficient. Overall, a 1°C error in the temperature measurement produces about a 2% error in the solubility calculated during calibration and about the same error in subsequent measurements.

Without calibration the accuracy of the temperature measurement is about $\pm 0.4^\circ\text{C}$. Calibrate the controller if

1. $\pm 0.4^\circ\text{C}$ accuracy is not acceptable
2. the temperature measurement is suspected of being in error. Calibrate temperature by making the controller reading match the temperature measured with a standard thermometer.

6.2 TEMPERATURE CALIBRATION

Place the sensor and a standard thermometer in the process liquid.

1. Check the analyzer temperature reading (main display) to make sure the sensor has stabilized. Compare the analyzer temperature with the standard thermometer. The readings should differ by at most 1°C. If the readings differ by a greater amount, refer to Section 15.3. Go to the next step if the reading requires adjustment.
2. From the main display, press any key. With the cursor on "Calibrate," press Enter (F4).

NOTE

If Hold was enabled in Section 5.5, the hold screen will appear. To activate hold, refer to Section 5.5, step 9.

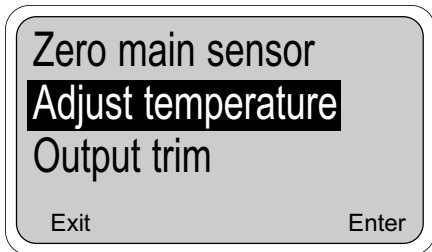

3. Press the ↓ key twice to move the cursor to "Adjust temperature," then press Enter (F4).

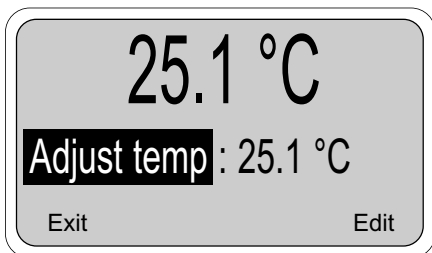

4. Press Edit (F4) to adjust the temperature. The screen below will then appear. Using the arrow keys, enter the correct temperature and press Save (F4). The controller will enter the value in memory. To abort the change, press Esc (F3). Press Exit (F1) three times for the main display.

NOTE

If Hold was activated during calibration, "Hold Mode Activated" will continue to flash in the main display. Return the sensor to normal and deactivate Hold. Refer to Section 5.5, step 9.

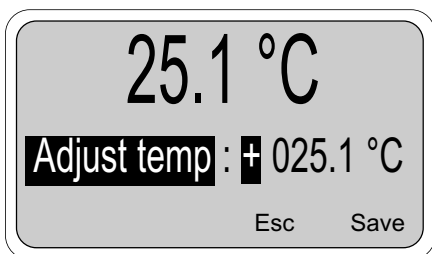

SECTION 7.0

CALIBRATION - DISSOLVED OXYGEN

7.1 INTRODUCTION

As Figure 7-1 shows, oxygen sensors generate a current directly proportional to the concentration of dissolved oxygen in the sample. Calibrating the sensor requires exposing it to a solution containing no oxygen (zero standard) and to a solution containing a known amount of oxygen (full-scale standard).

The zero standard is necessary because oxygen sensors, even when no oxygen is present in the sample, generate a small current called the residual current. The analyzer compensates for the residual current by subtracting it from the measured current before converting the result to a dissolved oxygen value. New sensors require zeroing before being placed in service, and sensors should be zeroed whenever the electrolyte solution is replaced. The recommended zero standard is 5% sodium sulfite in water, although oxygen-free nitrogen can also be used.

The purpose of the full-scale standard is to establish the slope of the calibration curve. Because the solubility of atmospheric oxygen in water as a function of temperature and barometric pressure is well known, the natural choice for a full-scale standard is air-saturated water. However, air-saturated water is difficult to prepare and use, so the universal practice is to use air for calibration. From the point of view of the oxygen sensor, air and air-saturated water are identical. The equivalence comes about because the sensor really measures the chemical potential of oxygen. Chemical potential is the force that causes oxygen molecules to diffuse from the sample into the sensor where they can be measured. It is also the force that causes oxygen molecules in air to dissolve in water and to continue to dissolve until the water is saturated with oxygen. Once the water is saturated, the chemical potential of oxygen in the two phases (air and water) is the same.

Oxygen sensors generate a current directly proportional to the rate at which oxygen molecules diffuse through a membrane stretched over the end of the sensor. The diffusion rate depends on the difference in chemical potential between oxygen in the sensor and oxygen in the sample. An electrochemical reaction, which destroys any oxygen molecules entering the sensor, keeps the concentration (and the chemical potential) of oxygen inside the sensor equal to zero. Therefore, the chemical potential of oxygen in the sample alone determines the diffusion rate and the sensor current.

When the sensor is calibrated, the chemical potential of oxygen in the standard determines the sensor current. Whether the sensor is calibrated in air or air-saturated water is immaterial. The chemical potential of oxygen is the same in either phase. Normally, to make the calculation of solubility in common units (like ppm DO) simpler, it is convenient to use water-saturated air for calibration.

Automatic air calibration is standard. The user simply exposes the sensor to water-saturated air. The analyzer monitors the sensor current. When the current is stable, the analyzer stores the current and measures the barometric pressure and temperature. The temperature element is part of the dissolved oxygen sensor. The pressure sensor is inside the analyzer. From the temperature, the analyzer calculates the saturation vapor pressure of water. Next, it calculates the pressure of dry air by subtracting the vapor pressure from the barometric pressure. Using the fact that dry air always contains 20.95% oxygen, the analyzer calculates the partial pressure of oxygen. Once the analyzer knows the partial pressure of oxygen, it uses the Bunsen coefficient to calculate the equilibrium solubility of atmospheric oxygen in water at the prevailing temperature. At 25°C and 760 mm Hg, the equilibrium solubility is 8.24 ppm.

Often it is too difficult or messy to remove the sensor from the process liquid for calibration. In this case, the sensor can be calibrated against a measurement made with a portable laboratory instrument. The laboratory instrument typically uses a membrane-covered amperometric sensor that has been calibrated against water-saturated air.

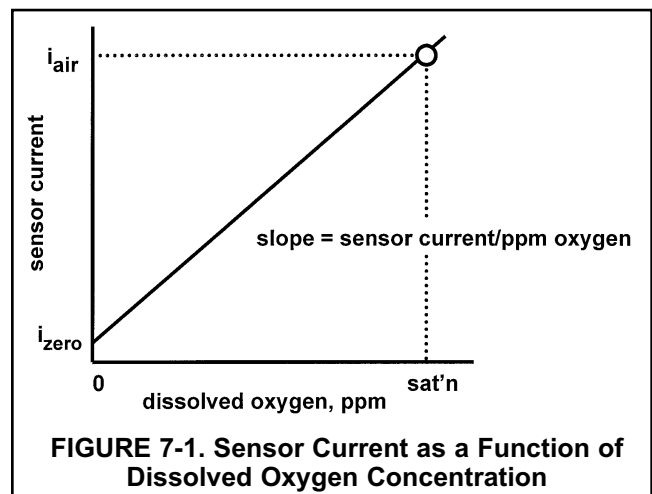

7.2 ZEROING THE SENSOR

1. Place the sensor in a **fresh** solution of 5% sodium sulfite (Na_2SO_3) in water. Be sure air bubbles are not trapped against the membrane. The current will drop rapidly at first and then gradually reach a stable zero value. To monitor the sensor current, go to the main display. Press any key to obtain the main menu. Press the \downarrow key once to highlight "Diagnostic variables." Press Enter (F4). The sensor current is the second item in the display. Note the units: nA is nanoamps, μA is microamps. To return to the main display, press exit (F1) twice. Typical zero current for a 499ADO sensor is less than 50 nA.

A new sensor or a sensor in which the electrolyte solution has been replaced may require several hours (occasionally as long as overnight) to reach a minimum current. **DO NOT START THE ZERO ROUTINE UNTIL THE SENSOR HAS BEEN IN ZERO SOLUTION FOR AT LEAST TWO HOURS.**

2. From the main display, press any key to obtain the main menu. With the cursor on "Calibrate," press Enter (F4).

NOTE

If Hold was enabled in Section 5.5, the hold screen will appear. To activate hold, refer to Section 5.5, step 9.

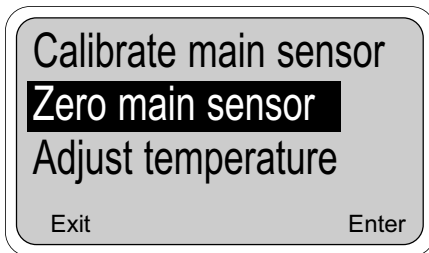

3. Press the \downarrow key once to move the cursor to "Zero main sensor." Press Enter (F4).

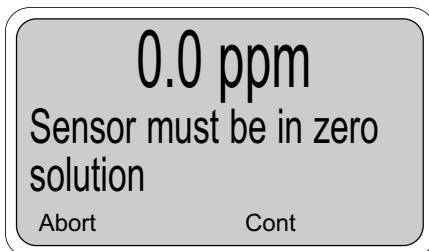

4. The screen at left appears. Press Cont (F3). "Wait" flashes until the sensor is stabilized. Once the zero step is complete, the message "Sensor zero done" appears.
5. Press Exit (F1) three times to return to the main display.

NOTE

If Hold was activated during calibration, "Hold Mode Activated" will continue to flash in the main display. Return the sensor to normal and deactivate Hold. Refer to Section 5.5, step 9.

NOTE

During calibration, ERROR and WARNING messages may appear. If an ERROR message appears, press Exit (F1) to leave and return to the previous screen. If a WARNING message appears, press Cont (F3) to continue the calibration or press Abort (F1) to leave. Continuing the calibration after a warning message appears may cause substantial errors in the subsequent measurement. Refer to Section 15.4 for assistance.

7.3 CALIBRATING THE SENSOR IN AIR

1. Remove the sensor from the process liquid. Use a soft tissue and a stream of water from a wash bottle to clean the membrane. Blot dry. **The membrane must be dry during air calibration.**
2. Pour some water in a beaker and suspend the sensor with the membrane about 0.5 inch (1 cm) above the water surface. To avoid drift caused by temperature changes, keep the sensor out of the direct sun.
3. Monitor the dissolved oxygen reading and the temperature. Once readings have stopped drifting, begin the calibration. It may take 5 - 10 minutes for the sensor reading in air to stabilize. Stabilization time may be even longer if the process temperature is appreciably different from the air temperature. For an accurate calibration, temperature measured by the sensor must be stable.

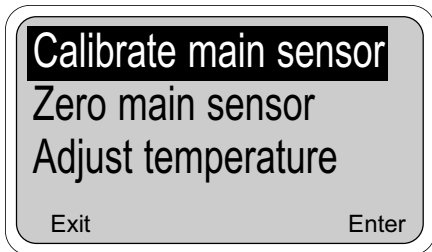

4. From the main display, press any key to obtain the main menu. With the cursor on "Calibrate," press Enter (F4).

NOTE

If Hold was enabled in Section 5.5, the hold screen will appear. To activate hold, refer to Section 5.5, step 9.

Press Enter (F4). The screen shown in step 5 appears.

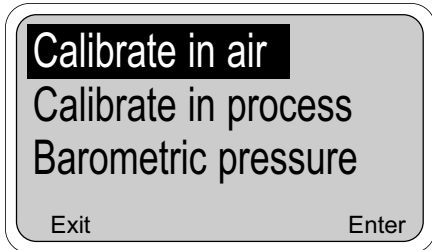

5. Press Enter (F4) to select "Calibrate in air."

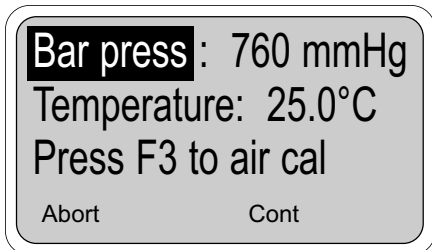

6. This screen shows the barometric pressure and temperature that will be used for the calibration. If the barometric pressure or temperature is incorrect, press Abort (F1). Refer to Section 7.5 for the pressure calibration procedure. Refer to Section 6.2 for the temperature calibration procedure.

NOTE

The barometric pressure sensor is inside the controller enclosure. When cable glands are in place and the front panel is tightly closed, the enclosure is moderately airtight. Therefore, as the controller heats or cools, the pressure of the air trapped inside the enclosure may be different from ambient. Opening the front panel will equalize the pressure.



7. Press Cont (F3). "Wait" flashes until the sensor is stabilized. Once air calibration is complete, the message "Air calibration done" appears. The display will show the equilibrium solubility of atmospheric oxygen in water at the prevailing temperature and pressure.

procedure continued on next page . . .

8. Press Exit (F1) four times to return to the main display.

NOTE

If Hold was activated during calibration, "Hold Mode Activated" will continue to flash in the main display. Return the sensor to normal and deactivate Hold. Refer to Section 5.5, step 9.

9. During calibration, the analyzer stores the measured current and calculates the sensitivity. Sensitivity is the sensor current in nA divided by the saturation concentration of oxygen in ppm. Typical sensitivity for a 499ADO sensor is 1,800 to 3,100 nA/ppm (15 - 25 μ A in air).

To view the sensitivity from the main display, press any key to enter the main menu. Press the \blacktriangledown key once. Then press Enter (F4) to display the diagnostic variables. The sensitivity is the third line on the screen. Note the units: nA is nanoamps, μ A is microamps.

NOTE

During calibration, ERROR and WARNING messages may appear. If an ERROR message appears, press Exit (F1) to leave and return to the previous screen. If a WARNING message appears, press Cont (F3) to continue the calibration or press Abort (F1) to leave. Continuing the calibration after a warning message appears may cause substantial errors in the subsequent measurement. Refer to Section 15.4 for assistance.

7.4 CALIBRATING THE SENSOR AGAINST A STANDARD INSTRUMENT

The analyzer and sensor can be calibrated against a standard instrument. For oxygen sensors installed in aeration basins in waste treatment plants, calibration against a second instrument is often preferred. For an accurate calibration be sure that...

1. The standard instrument has been zeroed and calibrated against water-saturated air following the manufacturer's instructions.
2. The standard sensor is immersed in the liquid as close to the process sensor as possible.
3. Adequate time is allowed for the standard sensor to stabilize before calibrating the process instrument.

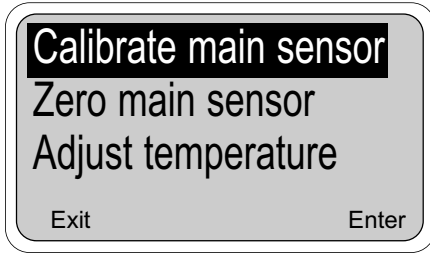

4. From the main display, press any key to obtain the main menu. With the cursor on "Calibrate," press Enter (F4).

NOTE

If Hold was enabled in Section 5.5, the hold screen will appear. To activate hold, refer to Section 5.5, step 9.

Press Enter (F4).



5. The screen at left appears. Press the ↓ key once to move the cursor to "Calibrate in process." Then, press Enter (F4).

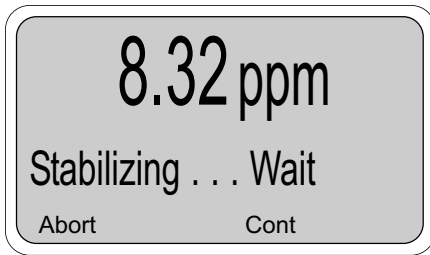

6. Press Cont (F3). "Wait" flashes until the sensor is stabilized.

If the analyzer appears locked, the reading is not stable enough. Increase the amount the concentration is permitted to vary or decrease the stabilization time. See Section 5.10. Repeat the calibration. To proceed with the calibration as is, press Cont (F3).

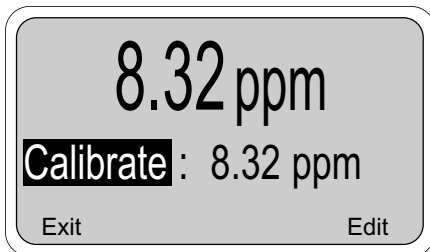

7. Once the reading is stable, the screen at left appears. Press Edit (F4). Use the arrow keys to change the concentration in the second line of the display to the desired value. Press Save (F4) to store the value.

8. Press Exit (F1) four times to return to the main display.

NOTE

If Hold was activated during calibration, "Hold Mode Activated" will continue to flash in the main display. Return the sensor to normal and deactivate Hold. Refer to Section 5.5, step 9.

7.5 CALIBRATING BAROMETRIC PRESSURE

1. If the barometric pressure measured by the analyzer does not agree with the local barometric pressure, calibrate the pressure sensor. A pressure error of 3 mm Hg introduces an error of about 0.5% in the final measurement. When calibrating the pressure reading, be sure to use the actual barometric pressure. Weather forecasters and airports usually report barometric pressure corrected to sea level; they do not report the actual pressure. It is good practice to open the enclosure door before starting a barometric pressure calibration. When gland fittings are used, the analyzer enclosure is moderately airtight. As the analyzer enclosure heats or cools, the pressure of the air trapped inside the enclosure may be as much as 5% different from ambient pressure.

2. From the main display, press any key. With the cursor on "Calibrate," press Enter (F4).

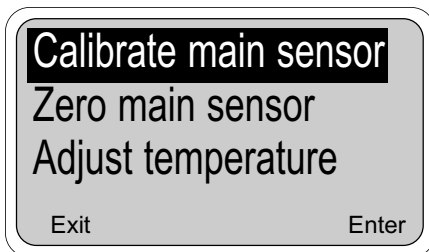

3. Press Enter (F4) to select "Calibrate main sensor."

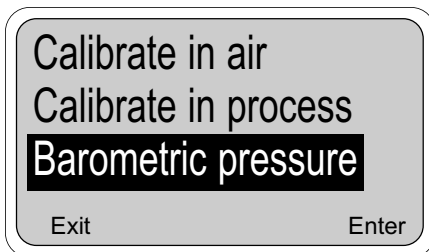

4. Press the ↓ key twice to move the cursor to "Barometric pressure." Press Enter (F4).

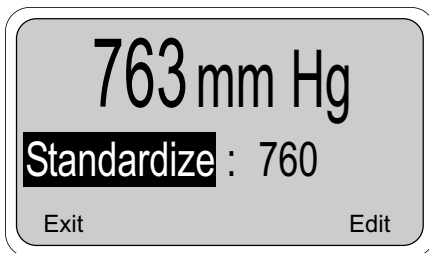

5. Press Edit (F4). Use the arrow keys to change the pressure reading to the desired value. Press Save (F4) to store the value.

6. Press Exit (F1) four times to return to the main display.

SECTION 8.0

CALIBRATION - CURRENT OUTPUTS

8.1 INTRODUCTION

Although the analyzer outputs are calibrated at the factory, they can be trimmed in the field to match the reading from a standard current meter. Both the low output (0 or 4 mA) and the high output (20 mA) can be trimmed.

8.2 TRIMMING THE OUTPUTS

1. From the main display, press any key to obtain the main menu. With the cursor on "Calibrate" press Enter (F4).

NOTE

If Hold was enabled in Section 5.6, the hold screen will appear. To activate hold, refer to Section 5.6, step 11.

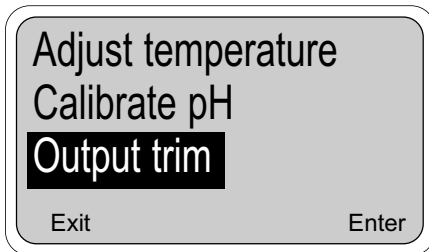

2. Move the cursor to "Output trim" and press Enter (F4).

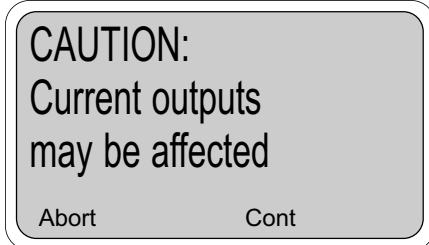

3. The warning screen reminds the user that the output currents will be affected. Press Cont (F3) to continue.

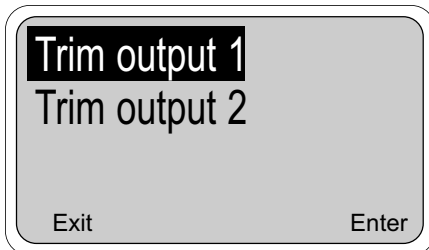

4. Use the \uparrow or \downarrow keys to move the cursor to the desired output and press Enter (F4).

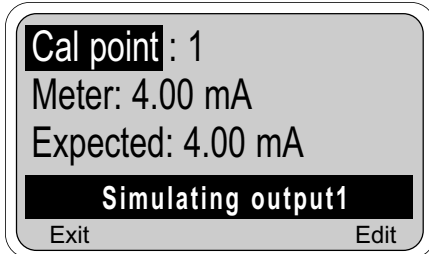

5. Select "Cal point 1" (0 or 4 mA) or "Cal point 2" (20 mA).
6. Move the cursor to "Meter" and press Enter (F4). Measure the output current with a calibrated ammeter. Use the \uparrow or \downarrow keys to change the display to match the ammeter reading and press Save (F4).
7. Move the cursor to the other "Cal point" and select it. Repeat step 6.

NOTE

If Hold was activated during calibration, "Hold Mode Activated" will continue to flash in the main display. Return the sensor to normal and deactivate Hold. Refer to Section 5.6, step 11.

SECTION 9.0 MAINTENANCE

9.1 ANALYZER (MODEL 54eA-01)

The Model 54eA-01 analyzer provided with the Model DO-03/04 system requires little routine maintenance.

Clean the analyzer enclosure and front panel by wiping with a clean soft cloth dampened with water. A mild detergent solution can also be used. Do not use solvents, like alcohol, that might cause a buildup of static charge.

Table 9-1 gives a list of replacement parts.

TABLE 9-1. Replacement Parts

PART NUMBER	DESCRIPTION
23540-05	Enclosure, Front with Keyboard
23848-00	Power Supply Circuit Board Shield
23849-00	Half Shield, Power Supply
23969-02	PCB, CPU and power supply, calibrated, 115/230 Vac
23969-06	PCB, CPU and power supply, calibrated, 24 Vdc
33281-00	Hinge Pin
33286-00	Gasket, Front Panel
33293-00	Enclosure, Rear
9010377	Back-lit Display, LCD Dot Matrix
9510048	Enclosure Conduit Plug, 1/2 inch

9.2 OXYGEN SENSOR (MODEL 499ADO-54)

9.2.1 General

The oxygen sensor requires little maintenance. Generally, the sensor needs attention when the response becomes sluggish or noisy or when readings drift following calibration.

9.2.2 Cleaning the membrane

Although the air blast cleaner does a good job of keeping the membrane clean, a thin film of slime can eventually accumulate on the membrane. Slime can be removed by rinsing the membrane with clean water. A soft cloth or tissue can also be used to wipe the membrane.

9.2.3 Replacing electrolyte solution and membrane

To replace the membrane or fill solution, the sensor must first be removed from the air blast washer head assembly.

To remove the sensor from the air blast cleaner ...

1. A pair of O-rings and a set screw hold the two parts of the sensor washer head assembly together. Remove the set screw and pull on the bottom of the assembly until it is clear. The quick disconnect for the air hose should be easily accessible.
2. Disconnect the air hose by pressing on the metal tab of the fitting and pulling the hose away from the base.
3. Unscrew the base from the sensor. **DO NOT LOSE THE O-RING THAT SEALS THE SENSOR TO BOTTOM ASSEMBLY.**

To reassemble the sensor and air blast cleaner...

1. Inspect the sensor O-ring. If it is cracked or cut, replace it. Clean the O-ring and slide it over the end of the sensor until it rests against the lower edge of the bottom facing threads.
2. Clean and dry the bottom portion of the sensor washer assembly. Inspect the surface that the sensor O-ring seals against to verify that it is clean and smooth. Inspect the dual O-rings to ensure that they are not cracked or cut. If the O-rings appear to be damaged, replace them.

NOTE

The sensor O-ring and the two washer head O-rings are available in PN 24053-00.

3. Be sure the O-ring sealing surfaces in the upper portion of the sensor washer head assembly are clean and smooth.
4. Reconnect the air hose.
5. Lubricate the O-rings with a small amount of grease. Push the bottom part of the sensor washer head back into the upper portion of the assembly. Replace and tighten the set screw.

To replace the electrolyte solution and membrane...

1. Unscrew the membrane retainer and remove the membrane assembly and O-ring. See Figure 9-1.
2. Hold the sensor over a container with the cathode pointing down.
3. Remove the fill plug and allow the electrolyte solution to drain out.
4. Inspect the cathode. If it is tarnished, clean it by gently rubbing in the direction of the existing scratches (do not use a circular motion) with 400-600 grit silicon carbide finishing paper. Rinse the cathode thoroughly with water.
5. Wrap the plug with several turns of pipe tape and set aside.
6. Prepare a new membrane. Hold the membrane assembly with the cup formed by the membrane and membrane holder pointing up. Fill the cup with electrolyte solution. Leave the membrane assembly filled with electrolyte solution and set it aside.
7. Hold the sensor at about a 45-degree angle with the cathode end pointing up. Add electrolyte solution through the fill hole until the liquid overflows. Tap the sensor near the threads to release trapped air bubbles. Add more electrolyte solution if necessary.
8. Place the fill plug in the electrolyte port and begin screwing it in. After several threads have engaged, rotate the sensor so that the cathode is pointing up and continue tightening the fill plug. Do not overtighten.
9. Place a new O-ring in the groove around the cathode post. Cover the holes at the base of the cathode stem with several drops of electrolyte solution.
10. Insert a small blunt probe, like a toothpick with the end cut off, through the pressure equalizing port. See Figure 9-1.

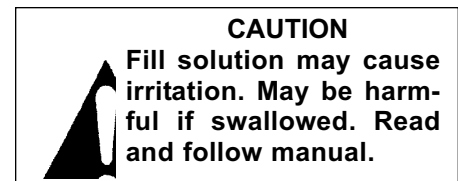

NOTE

Do not use a sharp probe. It will puncture the bladder and destroy the sensor.

Gently press the probe against the bladder several times to force liquid through the holes at the base of the cathode stem. Keep pressing the bladder until no air bubbles can be seen leaving the holes. Be sure the holes remain covered with electrolyte solution.

11. Place a drop of electrolyte solution on the cathode, then place the membrane assembly over the cathode. Screw the membrane retainer in place.
12. The sensor may require several hours operating at the polarizing voltage to equilibrate after the electrolyte solution has been replenished.

NOTE

If the membrane and electrolyte solution were replaced, check the sensor performance before reassembling the sensor and washer head assembly. To zero the sensor, refer to Section 7.2. To perform an air calibration, refer to Section 7.3.

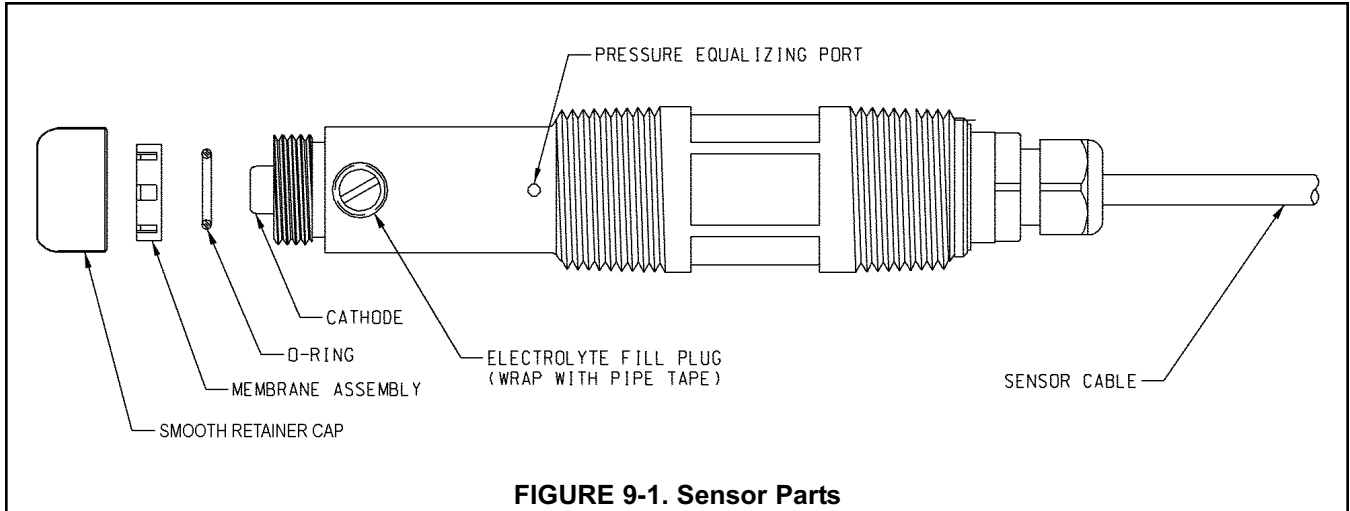

FIGURE 9-1. Sensor Parts

SPARE PARTS

33523-00	Electrolyte Fill Plug
9550094	O-Ring, Viton 2-014
24057-00	Membrane Retainer (smooth cap)
23501-00	Dissolved Oxygen Membrane Assembly: includes one membrane assembly and one O-ring
23502-00	Dissolved Oxygen Membrane Kit: includes 3 membrane assemblies and 3 O-rings
9210264	#1 Dissolved Oxygen Sensor Fill Solution, 4 oz (120 mL)

9.3 AIR COMPRESSOR (PN 9380088 115Vac or PN 9380089 220 Vac)

The air compressor has no user-serviceable parts. It does not require lubrication. Fuse sizes are shown in the table. The fuse is located below the T-shaped plastic cover next to the air compressor.

Power	Fuse
100-115 Vac	AGC-4, 4A, 250V
230 Vac	AGC-2, 2A, 250V



⚠ DANGER
Hazardous Voltage
Can cause severe injury or death.
Disconnect power before servicing.

9.4 AIR BLAST SENSOR WASHER

The air blast sensor washer needs little routine maintenance. Replace the two large O-rings on the base of the washer head and the sensor sealing O-ring if they become cut or dirty or if there is evidence of water leaking into the washer head. The three O-rings are available as a kit (PN 24053-00).

See Figure 9-2 for replacement parts.

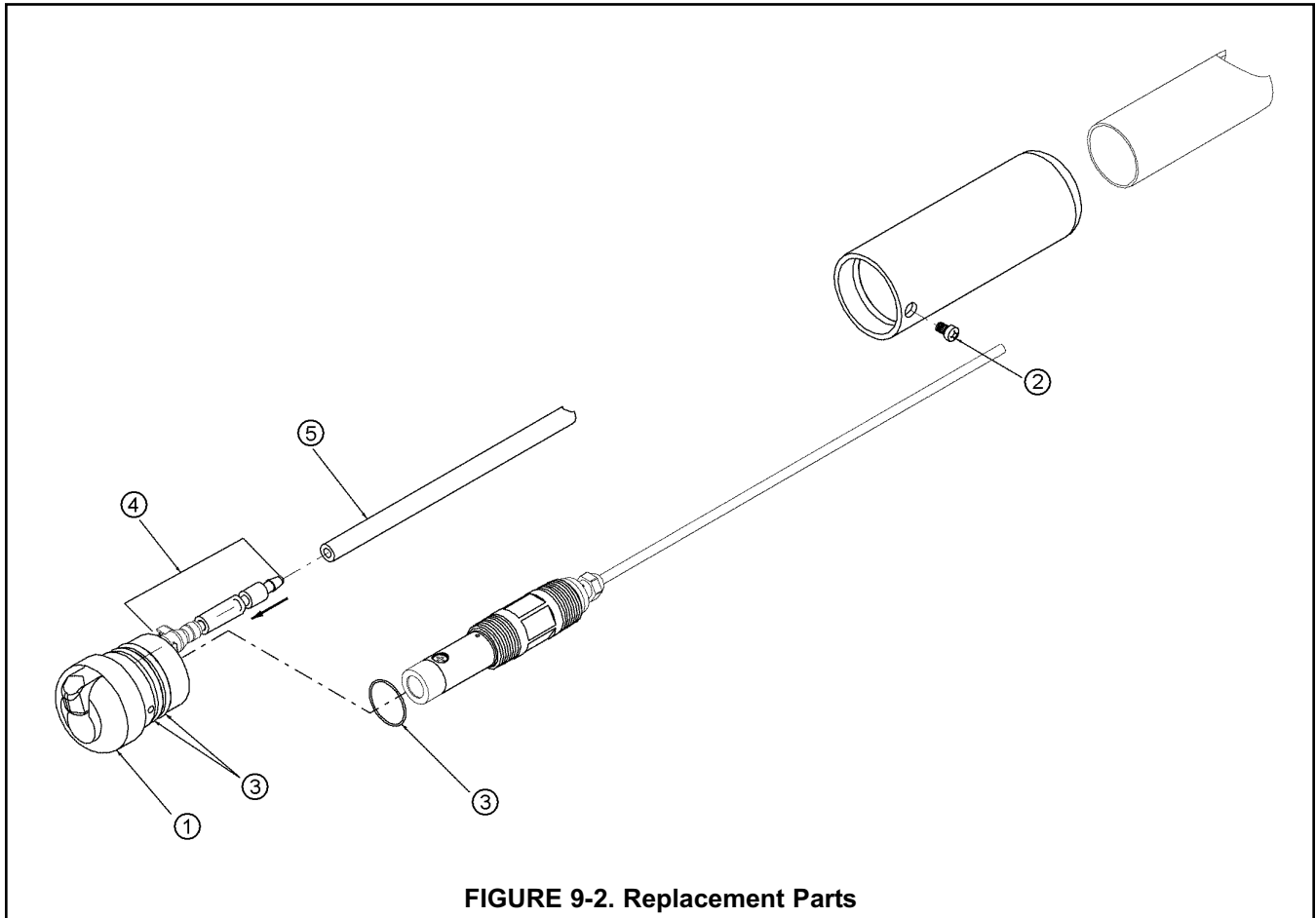

FIGURE 9-2. Replacement Parts

Location	Part Number	Description
1	24049-00	Sensor washer head
2	note	Screw, 1/4 x 20 x 0.375 SFH
3	24054-00	O-ring kit, quantity 3 with barium lube
4	24055-00	Quick disconnect and check valve assembly
5	33866-00	Air hose, 25 ft, 1/4-inch ID

Screw size is for information only. Screw cannot be purchased from Rosemount.

SECTION 10.0 TROUBLESHOOTING

10.1 OVERVIEW

The 54eA analyzer continuously monitors itself and the sensor for faults. When the analyzer detects a fault in the oxygen sensor or in the instrument itself it displays a **fault message**. If alarm 4 was enabled, the red FAIL LED will also light and relay 4 will activate. The outputs will go to 22.00 mA or to the value programmed in Section 5.5.

See Section 10.2 for an explanation of fault messages and suggested corrective actions.

The analyzer also displays **error** and **warning messages** if a calibration is seriously in error. Refer to the section below for assistance. Each section also contains hints for correcting **other measurement and calibration problems**.

Measurement	Section
Temperature	10.3
Dissolved oxygen	10.4

For **troubleshooting not related to measurement** problems, see Section 10.5.

To view **diagnostic variables**, go to the main display and press any key. Move the cursor to “Diagnostic variables” and press Enter (F4). Use the **↑** or **↓** key to move up or down the list.

10.2 TROUBLESHOOTING WHEN A FAULT MESSAGE IS SHOWING

Fault message	Explanation	See Section
High input current	input current exceeds 210 uA	10.2.1
Check sensor zero	sensor current was too high when sensor was zeroed	10.2.2
Temp error low	temperature less than -15°C	10.2.3
Temp error high	temperature greater than 130°C	10.2.3
Sense line open	RTD sense line is open	10.2.4
Failure factory	instrument needs factory calibration	10.2.5
Failure eeprom	write verify error has occurred	10.2.5

10.2.1 High input current

Excessive sensor current implies that the oxygen sensor is miswired or the sensor has failed. Verify that wiring is correct, including connections through a junction box. See Section 3.3. If wiring is correct, try replacing the sensor.

105.2.2 Check sensor zero

The sensor current was extremely high when the sensor was zeroed. Typical zero current for an oxygen sensor is less than 50 nA. Zeroing the sensor before the zero current has reached a stable minimum value will lead to low results. Allow adequate time, possibly as long as overnight, for the sensor to stabilize before starting the zero routine.

10.2.3 Temperature error low or high

Temperature error usually means the RTD is open or shorted or there is an open or short in the connecting wiring. First, verify all wiring connections, including wiring connections in the junction box if one is being used. Next, disconnect the RTD IN, SENSE, and RETURN leads at the analyzer. Be sure to note the color of the wire and where it was attached. Measure the resistance between the RTD IN and RETURN leads. The resistance should be close to the value in the table in Section 10.7.2. If the temperature element is open or shorted, the sensor should be replaced. In the meantime use manual temperature compensation.

10.2.4 Sense line open

The 499ADO oxygen sensor uses a Pt100 in a three-wire configuration (see Figure 10-2). The in and return leads connect the RTD to the measuring circuit in the analyzer. A third wire, called the sense line, is connected to the return lead. The sense line allows the analyzer to correct for the resistance of the in and return leads and to correct for changes in lead wire resistance caused by changes in ambient temperature. If the sense line is open, check all wiring connections, including connections at a junction box. Next, verify that the sense line is open. Disconnect the sense and return leads and measure the resistance between them. It should be less than 5Ω. If the sense line is open, replace the sensor as soon as possible.

The analyzer can be operated with the sense line open. The measurement will be less accurate because the analyzer can no longer compensate for lead wire resistance. However, if the sensor is to be used at approximately constant ambient temperature, the lead wire resistance error can be eliminated by calibrating the sensor at the measurement temperature. Errors caused by changes in resistance with changes in ambient temperature cannot be eliminated. To make the error message disappear, connect the RTD sense and return terminal with a jumper.

10.2.5 Failure factory and Failure eeprom

Turn the power off, wait about 30 sec, then turn the power back on. If the error message does not clear, call the factory. In the United States, call (800) 854-8257. Outside the United States, call (949) 757-8500.

10.3 TROUBLESHOOTING WHEN NO FAULT MESSAGE IS SHOWING - TEMPERATURE**10.3.1 Temperature measured by standard was more than 1°C different from analyzer.**

- A. Is the standard thermometer, RTD, or thermistor accurate? General purpose liquid-in-glass thermometers, particularly ones that have been mistreated, can have surprisingly large errors.
- B. Is the temperature element in the sensor completely submerged in the liquid?
- C. Is the standard temperature sensor submerged to the correct level?

10.4 TROUBLESHOOTING WHEN NO FAULT MESSAGE IS SHOWING - OXYGEN

Problem	See Section
Zero current was accepted, but current is greater than about 50 nA	10.4.1
Error or warning message while zeroing the sensor (zero current is too high)	10.4.1
Zero reading is unstable	10.4.2
Sensor can be calibrated, but current is outside the range 1800 - 3100 nA/ppm	10.4.3
Possible error warning during air calibration	10.4.3
Possible error warning during in-process calibration	10.4.4
Barometric pressure reading is too high or too low	10.4.5
Process readings are erratic	10.4.6
Readings drift	10.4.7
Sensor does not respond to changes in oxygen level	10.4.8
Readings are too low	10.4.9

10.4.1 Zero current is too high

- A. Is the sensor properly wired to the analyzer? See Section 3.3.
- B. Is the membrane completely covered with zero solution and are air bubbles not trapped against the membrane? Swirl and tap the sensor to release air bubbles.
- C. Is the zero solution fresh and properly made? Zero the sensor in a solution of 5% sodium sulfite in water. Prepare the solution immediately before use. It has a shelf life of only a few days.
- D. If the sensor is being zeroed with nitrogen gas, verify that the nitrogen is oxygen-free and the flow is adequate to prevent back-diffusion of air into the chamber.
- E. The major contributor to the zero current is dissolved oxygen in the electrolyte solution inside the sensor. A long zeroing period usually means that an air bubble is trapped in the electrolyte. To ensure the 499ADO sensor contains no air bubbles, carefully follow the procedure for filling the sensor. See Section 9.2. If the electrolyte solution has just been replaced, allow several hours for the zero current to stabilize. On rare occasions, the sensor may require as long as overnight to zero.
- F. Check the membrane for damage and replace the membrane if necessary

10.4.2 Zero reading is unstable.

- A. Is the sensor properly wired to the analyzer? See Section 3.3. Verify that all wiring connections are tight.
- B. Readings are often erratic when a new or rebuilt sensor is first placed in service. Readings usually stabilize after an hour.
- C. Is the space between the membrane and cathode filled with electrolyte solution and is the flow path between the electrolyte reservoir and the membrane clear? Often the flow of electrolyte can be started by simply holding the sensor with the membrane end pointing down and sharply shaking the sensor a few times as though shaking down a clinical thermometer. If shaking does not work, perform the checks below. Refer to the sensor instruction manuals for additional information.

Verify that the holes at the base of the cathode stem are open (use a straightened paperclip to clear the holes). Also verify that air bubbles are not blocking the holes. Fill the reservoir and establish electrolyte flow to the cathode. Refer to the sensor instruction manual for the detailed procedure.

10.4.3 Sensor can be calibrated, but current in air is too high or too low

- A. Is the sensor properly wired to the analyzer? See Section 3.3. Verify that all connections are tight.
- B. Is the membrane dry? The membrane must be dry during air calibration. A droplet of water on the membrane during air calibration will lower the sensor current and cause an inaccurate calibration.
- C. If the sensor current in air is very low and the sensor is new, either the electrolyte flow has stopped or the membrane is torn or loose. For instructions on how to restart electrolyte flow see Section 10.4.2. To replace a torn membrane, refer to Section 9.2.
- D. Is the temperature low? Sensor current is a strong function of temperature. The sensor current decreases about 3% for every °C drop in temperature.
- E. Is the membrane fouled or coated? Slime, oil, and solids inhibit diffusion of oxygen through the membrane, reducing the sensor current. Clean the membrane by rinsing it with a stream of water from a wash bottle or by gently wiping the membrane with a soft tissue. Also, increase the air blast cleaning frequency and duration. If cleaning the membrane and increasing the air blast frequency do not improve the sensor response, replace the membrane and electrolyte solution. If necessary, polish the cathode. See Section 9.2 for more information.

10.4.4 Possible error warning during in-process calibration

This error warning appears if the current process reading and the reading it is being changed to, ie, the reading from the standard instrument, are appreciably different.

- A. Is the standard instrument properly zeroed and calibrated?
- B. Are the standard and process sensor measuring the same sample? Place the sensors as close together as possible.
- C. Is the process sensor working properly? Check the response of the process sensor in air and in sodium sulfite solution.

10.4.5 Barometric pressure reading is too high or too low.

- A. Is the pressure inside the enclosure equal to ambient pressure? The pressure sensor is inside the analyzer enclosure. When cable glands are in place and the front panel is tightly closed, the enclosure is moderately airtight. Therefore, as the air trapped in the enclosure heats or cools, the pressure inside the enclosure may be different from ambient. Open the front door to equalize the pressure.
- B. If equalizing the pressure does not solve the problem, the pressure sensor is out of calibration. Calibrate the sensor against the **local** barometric pressure. Be sure to use the actual barometric pressure. Pressure, sometimes called altimeter, from a local airport or pressure from a weather forecasting service is usually corrected to sea level. It is not the actual barometric pressure.

10.4.6 Process readings are erratic.

- A. Readings are often erratic when a new sensor or a rebuilt sensor is first placed in service. The current usually stabilizes after a few hours.
- B. Is the sample flow within the recommended range? High sample flow may cause erratic readings. Refer to the sensor instruction manual for recommended flow rates.
- C. Gas bubbles impinging on the membrane may cause erratic readings. Orienting the sensor at an angle away from vertical may reduce the noise.
- D. The holes between the membrane and electrolyte reservoir might be plugged. Refer to Section 10.4.2.
- E. Verify that wiring is correct. Pay particular attention to shield and ground connections.
- F. Is the membrane in good condition and is the sensor filled with electrolyte solution? Replace the fill solution and electrolyte. Refer to Section 9.2 for details.

10.4.7 Readings drift.

- A. Is the sample temperature changing? Membrane permeability is a function of temperature. The time constant for response to a temperature change is about 5 minutes. Therefore, the reading may drift for a while after a sudden temperature change.
- B. Is the membrane clean? For the sensor to work properly oxygen must diffuse freely through the membrane. A coating on the membrane will interfere with the passage of oxygen, resulting in slow response.
- C. Is the sensor in direct sunlight? If the sensor is in direct sunlight during air calibration, readings will drift as the sensor warms up. Because the temperature reading lags the true temperature of the membrane, calibrating the sensor in direct sunlight may introduce an error.
- D. Is the sample flow within the recommended range? Gradual loss of sample flow will cause downward drift.
- E. Is the sensor new or has it been recently serviced? New or rebuilt sensors may require several hours to stabilize.

10.4.8 Sensor does not respond to changes in oxygen level.

- A. If readings are being compared with a portable laboratory instrument, verify that the laboratory instrument is working.
- B. Is the membrane clean? Clean the membrane and replace it if necessary. Also, increase the frequency and duration of the air blast. Check that the holes at the base of the cathode stem are open. Use a straightened paper clip to clear blockages. Replace the electrolyte solution.
- C. Replace the sensor.

10.4.9 Oxygen readings are too low.

- A. Low readings can be caused by zeroing the sensor before the residual current has reached a stable minimum value. Residual current is the current the sensor generates even when no oxygen is in the sample. Because the residual current is subtracted from subsequent measured currents, zeroing before the current is a minimum can lead to low results.

Example: the true residual (zero) current for a 499ADO sensor is $0.05 \mu\text{A}$, and the sensitivity based on calibration in water-saturated air is $2.35 \mu\text{A/ppm}$. Assume the measured current is $2.00 \mu\text{A}$. The true concentration is $(2.00 - 0.05)/2.35$ or 0.83 ppm . If the sensor was zeroed prematurely when the current was $0.2 \mu\text{A}$, the measured concentration will be $(2.00 - 0.2)/2.35$ or 0.77 ppm . The error is 7.2%. Suppose the measured current is $5.00 \mu\text{A}$. The true concentration is 2.11 ppm , and the measured concentration is 2.05 ppm . The error is now 3.3%. The absolute difference between the readings remains the same, 0.06 ppm .

- B. Sensor response depends on flow. If the flow is too low, readings will be low and flow sensitive. Move the sensor to an area in the aeration basin where the flow or agitation is greater.

10.5 TROUBLESHOOTING NOT RELATED TO MEASUREMENT PROBLEMS

Problem	Action
Display segments missing	Replace display board
Alarm relays are chattering	1. Check alarm setpoints. 2. Increase hysteresis time delay settings (see Section 5.6)
Incorrect current output	1. Verify that output load is less than 600 Ω. 2. For minor errors, trim outputs (see Section 8.0) 3. Replace power supply board
Display too light or too dark	Change contrast (see Section 5.4)
“Level 1, 2 or 3 security: Lock” shown in display	Controller has password protection (see Section 5.11)
“Hold mode activated” showing in display	Controller is in hold (see Section 5.5, steps 8 and 9)
“Simulating output 1 or 2” showing in display	Controller is simulating outputs (see Section 5.3)
“Simulating alarm 1, 2, 3 or 4” showing in display	Controller is simulating alarms (see Section 5.3)

10.6 SIMULATING INPUTS - DISSOLVED OXYGEN

To check the performance of the controller, use a decade box to simulate the current from the oxygen sensor.

- A. Disconnect the anode and cathode leads from terminals 1 and 2 on TB3 and connect a decade box as shown in Figure 10-1. It is not necessary to disconnect the RTD leads.
- B. Set the decade box to the resistance shown in the table.

Sensor	Polarizing Voltage	Resistance	Expected current
499ADO	-675 mV	34 kΩ	20 μA

- C. Note the sensor current. To view the sensor current from the main display, press any key to enter the main menu. Move the cursor to "Diagnostics" and press Enter (F4). The sensor current is the second line in the display. Note the units: μA is microamps, nA is nanoamps.
- D. Change the decade box resistance and verify that the correct current is shown. Calculate current from the equation:

$$\text{current } (\mu\text{A}) = \frac{\text{voltage (mV)}}{\text{resistance (k}\Omega\text{)}}$$

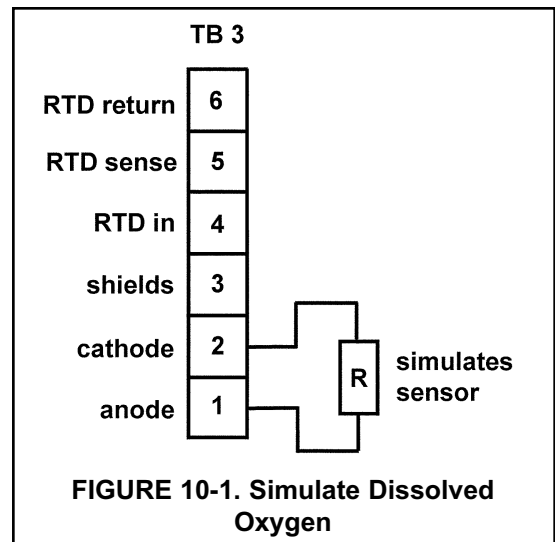

10.7 SIMULATING TEMPERATURE

10.7.1 General.

The 54eA analyzer accepts a Pt100 RTD. The Pt100 RTD is in a three-wire configuration. See Figure 10-2.

10.7.2 Simulating temperature

To simulate the temperature input, wire a decade box to the analyzer or junction box as shown in Figure 10-3.

To check the accuracy of the temperature measurement, set the resistor simulating the RTD to the values indicated in the table and note the temperature readings. The measured temperature might not agree with the value in the table. During sensor calibration an offset might have been applied to make the measured temperature agree with a standard thermometer. The offset is also applied to the simulated resistance. The controller is measuring temperature correctly if the difference between measured temperatures equals the difference between the values in the table to within $\pm 0.1^\circ\text{C}$.

For example, start with a simulated resistance of $103.9\ \Omega$, which corresponds to 10.0°C . Assume the offset from the sensor calibration was $-0.3\ \Omega$. Because of the offset, the analyzer calculates temperature using $103.6\ \Omega$. The result is 9.2°C . Now change the resistance to $107.8\ \Omega$, which corresponds to 20.0°C . The analyzer uses $107.5\ \Omega$ to calculate the temperature, so the display reads 19.2°C . Because the difference between the displayed temperatures (10.0°C) is the same as the difference between the simulated temperatures, the analyzer is working correctly.

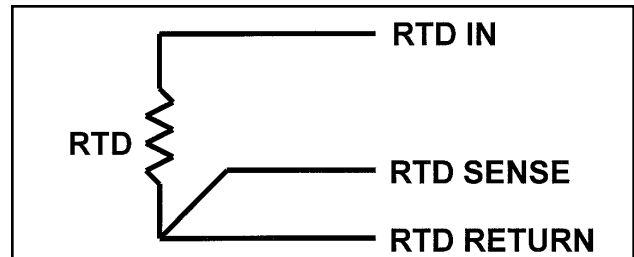

FIGURE 10-2. Three-Wire RTD Configuration.

Although only two wires are required to connect the RTD to the analyzer, using a third (and sometimes fourth) wire allows the analyzer to correct for the resistance of the lead wires and for changes in the lead wire resistance with temperature.

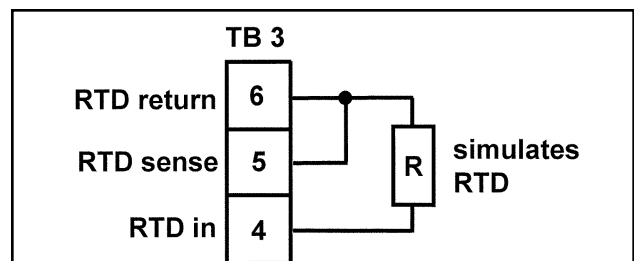

FIGURE 10-3. Simulating RTD Inputs.

The figure shows wiring connections for sensors containing a Pt 100 RTD.

Temp. ($^\circ\text{C}$)	Pt 100 (Ω)
0	100.0
10	103.9
20	107.8
25	109.7
30	111.7
40	115.5
50	119.4
60	123.2
70	127.1
80	130.9
85	132.8
90	134.7
100	138.5

SECTION 11.0 RETURN OF MATERIAL

11.1 GENERAL.

To expedite the repair and return of instruments, proper communication between the customer and the factory is important. Before returning a product for repair, call 1-949-757-8500 for a Return Materials Authorization (RMA) number.

11.2 WARRANTY REPAIR.

The following is the procedure for returning instruments still under warranty:

1. Call Rosemount Analytical for authorization.
2. To verify warranty, supply the factory sales order number or the original purchase order number. In the case of individual parts or sub-assemblies, the serial number on the unit must be supplied.
3. Carefully package the materials and enclose your "Letter of Transmittal" (see Warranty). If possible, pack the materials in the same manner as they were received.
4. Send the package prepaid to:

Emerson Process Management
 Liquid Division
 2400 Barranca Parkway
 Irvine, CA 92606

Attn: Factory Repair

RMA No. _____

Mark the package: Returned for Repair

Model No. _____

IMPORTANT

Please see second section of "Return of Materials Request" form. Compliance with the OSHA requirements is mandatory for the safety of all personnel. MSDS forms and a certification that the instruments have been disinfected or detoxified are required.

11.3 NON-WARRANTY REPAIR.

The following is the procedure for returning for repair instruments that are no longer under warranty:

1. Call Rosemount Analytical for authorization.
2. Supply the purchase order number, and make sure to provide the name and telephone number of the individual to be contacted should additional information be needed.
3. Do Steps 3 and 4 of Section 11.2.

NOTE

Consult the factory for additional information regarding service or repair.

RETURN OF MATERIALS REQUEST

•IMPORTANT!

This form must be completed to ensure expedient factory service.

FROM:	RETURN	BILL TO:													
CUSTOMER	_____	_____	_____												
NOTICE TO SENDER	<p>CUSTOMER/USER MUST SUBMIT MATERIAL SAFETY SHEET (MSDS) OR COMPLETE STREAM COMPOSITION, AND/OR LETTER CERTIFYING THE MATERIALS HAVE BEEN DISINFECTED AND/OR DETOXIFIED WHEN RETURNING ANY PRODUCT, SAMPLE OR MATERIAL THAT HAVE BEEN EXPOSED TO OR USED IN AN ENVIRONMENT OR PROCESS THAT CONTAINS A HAZARDOUS MATERIAL ANY OF THE ABOVE THAT IS SUBMITTED TO ROSEMOUNT ANALYTICAL WITHOUT THE MSDS WILL BE RETURNED TO SENDER C.O.D. FOR THE SAFETY AND HEALTH OF OUR EMPLOYEES. WE THANK YOU IN ADVANCE FOR COMPLIANCE TO THIS SUBJECT.</p>														
<p>SENSOR OR CIRCUIT BOARD ONLY: (Please reference where from in MODEL / SER. NO. Column)</p> <table style="width:100%; border-collapse: collapse;"> <tr> <td style="width: 33%;">1. PART NO. _____</td> <td style="width: 33%;">1. MODEL _____</td> <td style="width: 33%;">1. SER. NO. _____</td> </tr> <tr> <td>2. PART NO. _____</td> <td>2. MODEL _____</td> <td>2. SER. NO. _____</td> </tr> <tr> <td>3. PART NO. _____</td> <td>3. MODEL _____</td> <td>3. SER. NO. _____</td> </tr> <tr> <td>4. PART NO. _____</td> <td>4. MODEL _____</td> <td>4. SER. NO. _____</td> </tr> </table>				1. PART NO. _____	1. MODEL _____	1. SER. NO. _____	2. PART NO. _____	2. MODEL _____	2. SER. NO. _____	3. PART NO. _____	3. MODEL _____	3. SER. NO. _____	4. PART NO. _____	4. MODEL _____	4. SER. NO. _____
1. PART NO. _____	1. MODEL _____	1. SER. NO. _____													
2. PART NO. _____	2. MODEL _____	2. SER. NO. _____													
3. PART NO. _____	3. MODEL _____	3. SER. NO. _____													
4. PART NO. _____	4. MODEL _____	4. SER. NO. _____													
REASON FOR RETURN	<p>PLEASE CHECK ONE:</p> <p><input type="checkbox"/> REPAIR AND CALIBRATE <input type="checkbox"/> DEMO EQUIPMENT NO. _____</p> <p><input type="checkbox"/> EVALUATION <input type="checkbox"/> OTHER (EXPLAIN) _____</p> <p><input type="checkbox"/> REPLACEMENT REQUIRED? <input type="checkbox"/> YES <input type="checkbox"/> NO</p> <p>DESCRIPTION OF MALFUNCTION:</p> <p>_____</p> <p>_____</p> <p>_____</p>														
REPAIR STATUS	<p>WARRANTY REPAIR REQUESTED:</p> <p><input type="checkbox"/> YES-REFERENCE ORIGINAL ROSEMOUNT ANALYTICAL ORDER NO. _____</p> <p style="padding-left: 100px;">CUSTOMER PURCHASE ORDER NO. _____</p> <p><input type="checkbox"/> NO-PROCEED WITH REPAIRS-INVOICE AGAINST P.O. NO. _____</p> <p><input type="checkbox"/> NO-CONTACT WITH ESTIMATE OF REPAIR CHARGES: LETTER <input type="checkbox"/> _____</p> <p style="padding-left: 150px;">PHONE <input type="checkbox"/> _____</p>														
<p>NAME _____ PHONE _____</p> <p>ADDRESS _____</p> <p style="padding-left: 350px;">ZIP _____</p>															
<p>RETURN AUTHORITY FOR CREDIT ADJUSTMENT [Please check appropriate box(s)]</p> <table style="width:100%; border-collapse: collapse;"> <tr> <td style="width: 50%;"><input type="checkbox"/> WRONG PART RECEIVED</td> <td style="width: 50%;"><input type="checkbox"/> REPLACEMENT RECEIVED</td> </tr> <tr> <td><input type="checkbox"/> DUPLICATE SHIPMENT</td> <td>REFERENCE ROSEMOUNT ANALYTICAL SALES ORDER NO. _____</td> </tr> <tr> <td><input type="checkbox"/> RETURN FOR CREDIT</td> <td>RETURN AUTHORIZED BY: _____</td> </tr> <tr> <td colspan="2">WARRANTY DEFECT _____</td> </tr> </table>				<input type="checkbox"/> WRONG PART RECEIVED	<input type="checkbox"/> REPLACEMENT RECEIVED	<input type="checkbox"/> DUPLICATE SHIPMENT	REFERENCE ROSEMOUNT ANALYTICAL SALES ORDER NO. _____	<input type="checkbox"/> RETURN FOR CREDIT	RETURN AUTHORIZED BY: _____	WARRANTY DEFECT _____					
<input type="checkbox"/> WRONG PART RECEIVED	<input type="checkbox"/> REPLACEMENT RECEIVED														
<input type="checkbox"/> DUPLICATE SHIPMENT	REFERENCE ROSEMOUNT ANALYTICAL SALES ORDER NO. _____														
<input type="checkbox"/> RETURN FOR CREDIT	RETURN AUTHORIZED BY: _____														
WARRANTY DEFECT _____															

24-6047

Emerson Process Management

Liquid Division

2400 Barranca Parkway
Irvine, CA 92606 USA
Tel: (949) 757-8500
Fax: (949) 474-7250

<http://www.raihome.com>

© Rosemount Analytical Inc. 2004



WARRANTY

Seller warrants that the firmware will execute the programming instructions provided by Seller, and that the Goods manufactured or Services provided by Seller will be free from defects in materials or workmanship under normal use and care until the expiration of the applicable warranty period. Goods are warranted for twelve (12) months from the date of initial installation or eighteen (18) months from the date of shipment by Seller, whichever period expires first. **Consumables, such as glass electrodes, membranes, liquid junctions, electrolyte, o-rings, catalytic beads, etc., and Services are warranted for a period of 90 days from the date of shipment or provision.**

Products purchased by Seller from a third party for resale to Buyer ("Resale Products") shall carry only the warranty extended by the original manufacturer. Buyer agrees that Seller has no liability for Resale Products beyond making a reasonable commercial effort to arrange for procurement and shipping of the Resale Products.

If Buyer discovers any warranty defects and notifies Seller thereof in writing during the applicable warranty period, Seller shall, at its option, promptly correct any errors that are found by Seller in the firmware or Services, or repair or replace F.O.B. point of manufacture that portion of the Goods or firmware found by Seller to be defective, or refund the purchase price of the defective portion of the Goods/Services.

All replacements or repairs necessitated by inadequate maintenance, normal wear and usage, unsuitable power sources, unsuitable environmental conditions, accident, misuse, improper installation, modification, repair, storage or handling, or any other cause not the fault of Seller are not covered by this limited warranty, and shall be at Buyer's expense. Seller shall not be obligated to pay any costs or charges incurred by Buyer or any other party except as may be agreed upon in writing in advance by an authorized Seller representative. All costs of dismantling, reinstallation and freight and the time and expenses of Seller's personnel for site travel and diagnosis under this warranty clause shall be borne by Buyer unless accepted in writing by Seller.

Goods repaired and parts replaced during the warranty period shall be in warranty for the remainder of the original warranty period or ninety (90) days, whichever is longer. This limited warranty is the only warranty made by Seller and can be amended only in a writing signed by an authorized representative of Seller. Except as otherwise expressly provided in the Agreement, THERE ARE NO REPRESENTATIONS OR WARRANTIES OF ANY KIND, EXPRESS OR IMPLIED, AS TO MERCHANTABILITY, FITNESS FOR PARTICULAR PURPOSE, OR ANY OTHER MATTER WITH RESPECT TO ANY OF THE GOODS OR SERVICES.

RETURN OF MATERIAL

Material returned for repair, whether in or out of warranty, should be shipped prepaid to:

**Emerson Process Management
Liquid Division
2400 Barranca Parkway
Irvine, CA 92606**

The shipping container should be marked:

Return for Repair

Model _____

The returned material should be accompanied by a letter of transmittal which should include the following information (make a copy of the "Return of Materials Request" found on the last page of the Manual and provide the following thereon):

1. Location type of service, and length of time of service of the device.
2. Description of the faulty operation of the device and the circumstances of the failure.
3. Name and telephone number of the person to contact if there are questions about the returned material.
4. Statement as to whether warranty or non-warranty service is requested.
5. Complete shipping instructions for return of the material.

Adherence to these procedures will expedite handling of the returned material and will prevent unnecessary additional charges for inspection and testing to determine the problem with the device.

If the material is returned for out-of-warranty repairs, a purchase order for repairs should be enclosed.



*The right people,
the right answers,
right now.*

ROSEMOUNT ANALYTICAL
CUSTOMER SUPPORT CENTER
1-800-854-8257



Emerson Process Management

Liquid Division

2400 Barranca Parkway
Irvine, CA 92606 USA
Tel: (949) 757-8500
Fax: (949) 474-7250

<http://www.raihome.com>

ON-LINE ORDERING NOW AVAILABLE ON OUR WEB SITE
<http://www.raihome.com>

Specifications subject to change without notice.



Credit Cards for U.S. Purchases Only.

