

Instruction Manual

90003752

11/2003

Instruction Manual

AK Protocol

Communication Option for

MLT 1, MLT 2, MLT 3, MLT 4, MLT 5 and CAT 200

3rd Edition 11/2003



ROSEMOUNT
Analytical

www.EmersonProcess.com

EMERSON
Process Management

ESSENTIAL INSTRUCTIONS

READ THIS PAGE BEFORE PROCEEDING!

Emerson Process Management (Rosemount Analytical) designs, manufactures and tests its products to meet many national and international standards. Because these instruments are sophisticated technical products, you **MUST properly install, use, and maintain them** to ensure they continue to operate within their normal specifications. The following instructions **MUST be adhered to** and integrated into your safety program when installing, using and maintaining Emerson Process Management (Rosemount Analytical) products. Failure to follow the proper instructions may cause any one of the following situations to occur: Loss of life; personal injury; property damage; damage to this instrument; and warranty invalidation.

- **Read all instructions** prior to installing, operating, and servicing the product.
- If you do not understand any of the instructions, **contact your Emerson Process Management (Rosemount Analytical) representative** for clarification.
- **Follow all warnings, cautions, and instructions** marked on and supplied with the product.
- **Inform and educate your personnel in the proper installation, operation, and maintenance of the product.**
- **Install your equipment as specified in the Installation Instructions of the appropriate Instruction Manual and per applicable local and national codes.** Connect all products to the proper electrical and pressure sources.
- To ensure proper performance, **use qualified personnel** to install, operate, update, program, and maintain the product.
- When replacement parts are required, ensure that qualified people use replacement parts specified by Emerson Process Management (Rosemount Analytical). Unauthorized parts and procedures can affect the product's performance, place the safe operation of your process at risk, **and VOID YOUR WARRANTY.** Look-alike substitutions may result in fire, electrical hazards, or improper operation.
- **Ensure that all equipment doors are closed and protective covers are in place, except when maintenance is being performed by qualified persons, to prevent electrical shock and personal injury.**

The information contained in this document is subject to change without notice. Misprints reserved.

1st Edition 10/1998 2nd Edition 11/2001

3rd Edition 11/2003

© 2003 by Emerson Process Management

Emerson Process Management
GmbH & Co. OHG
Industriestrasse 1
D-63594 Hasselroth
Germany
T +49 (0) 6055 884-0
F +49 (0) 6055 884-209
Internet: www.EmersonProcess.com



Contents

I)	V24/RS232/485 Interface – Basics	1 - 1
1	Introduction	1 - 1
2	Hardware	1 - 2
3	Protocol settings	1 - 3
3.1	Command telegram	1 - 3
3.2	Response telegram	1 - 4
3.3	Command telegram for RS485 BUS operating	1 - 5
3.4	Response telegram for RS485 BUS operating.....	1 - 6
4	Specifications of data settings	1 - 7
4.1	Head telegram (Header)	1 - 7
4.2	Data block and error status byte	1 - 8
4.3	End of telegram.....	1 - 9
4.4	Command and response telegram timing	1 -10
4.5	Handling of malfunctions.....	1 -10
5	Examples for potential responses to control or write commands resp. to command telegrams with data (format) errors	1 -11
6	Function sequence and error status after the receipt of the "SRES" or "STBY" commands.....	1 -19
II)	V24/RS232/485 Interface – Single Analyzers and Systems	2 - 1
1	Basic Informations	2 - 2
2	List of all Codes [Commands - Overview including page numbers]	2 - 5
2.1	Control commands.....	2 - 5
2.2	Read commands.....	2 - 6
2.3	Write commands	2 - 7
3	Description of all Control Commands	2 - 8
4	Description of all Read Commands	2 -39
5	Description of all Write Commands.....	2 -85
 Supplement		
1	Overview about working AK commands in NGA devices	Supplement - 1
2	AK Service Commands.....	Supplement - 3

**Protocol settings of a serial interface
between a test bench control computer
and peripheral analyzers on exhaust test benches**

1. Introduction

The serial interface is made for slow point to point connections ($f \leq 10$ Hz). The communication between the test bench control computer (TBCC) and the peripheral analyzers works according to the master slave principle. That means that the peripheral analyzers will only answer with a response telegram to the command telegram of the TBCC. They will not send an own message.

You can distinguish two cases:

(1) Analyzers in a function unit (system)

Some analyzers are combined to a logical unit. They are connected to the TBCC via an front-end computer. In that case the communication will not take place directly between the TBCC and the analyzers, but between the TBCC and the front-end computer. Each analyzer or the whole system unit will be identified by a defined channel number:

K0 is the channel number for the whole defined system.

("Assembling command resp. assembling report")

Kn ($n=1, n_{max}$) is the channel number for each analyzer.

KV is the channel number for the front-end computer.

(2) Single analyzers

Each analyzer is connected directly to the TBCC. In that case the identification of each analyzer will be done by the hardware connections and not by a software control. That is why the two channel number bytes (Kn) could be deleted. But in spite of that the channel number is generally 0 (K0) to get a uniform protocol.

The data transfer will only be done by ASCII code to get an easy handling of the protocol with a terminal for simulation of the TBCC, the system unit and the analyzers. Therefore, no parity check will be done as data saving.

2. Hardware

- 1. Baud rate: 1200, 2400, 4800, 9600, 19200
- 2. Length of signs: 1 start bit
7 or 8 data bits
1 or 2 stop bits
- 3. Parity: even/odd/none
- 4. Operating: full duplex, no echo
- 5. Handshake: Xon/Xoff
- 6. Plug: 9 pin sub d, socket
- 7. Pin assignment: RS 232 module

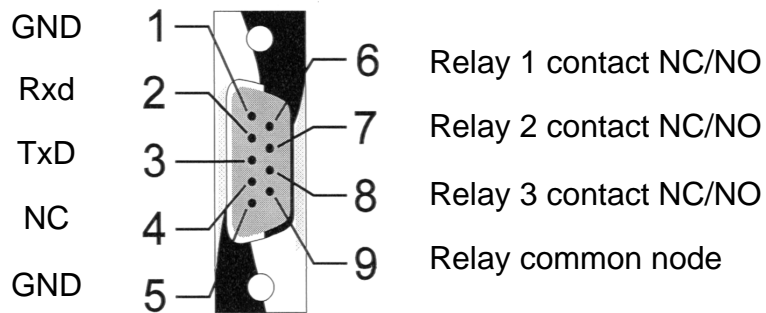

RS 485 module

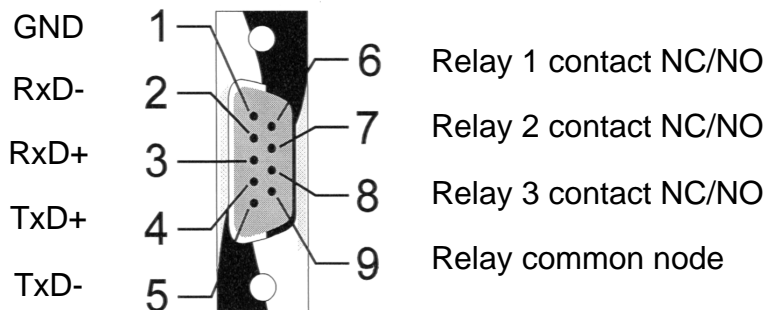

3. Protocol settings

The data and command transfer protocol has the following structure:

3.1. Command telegram

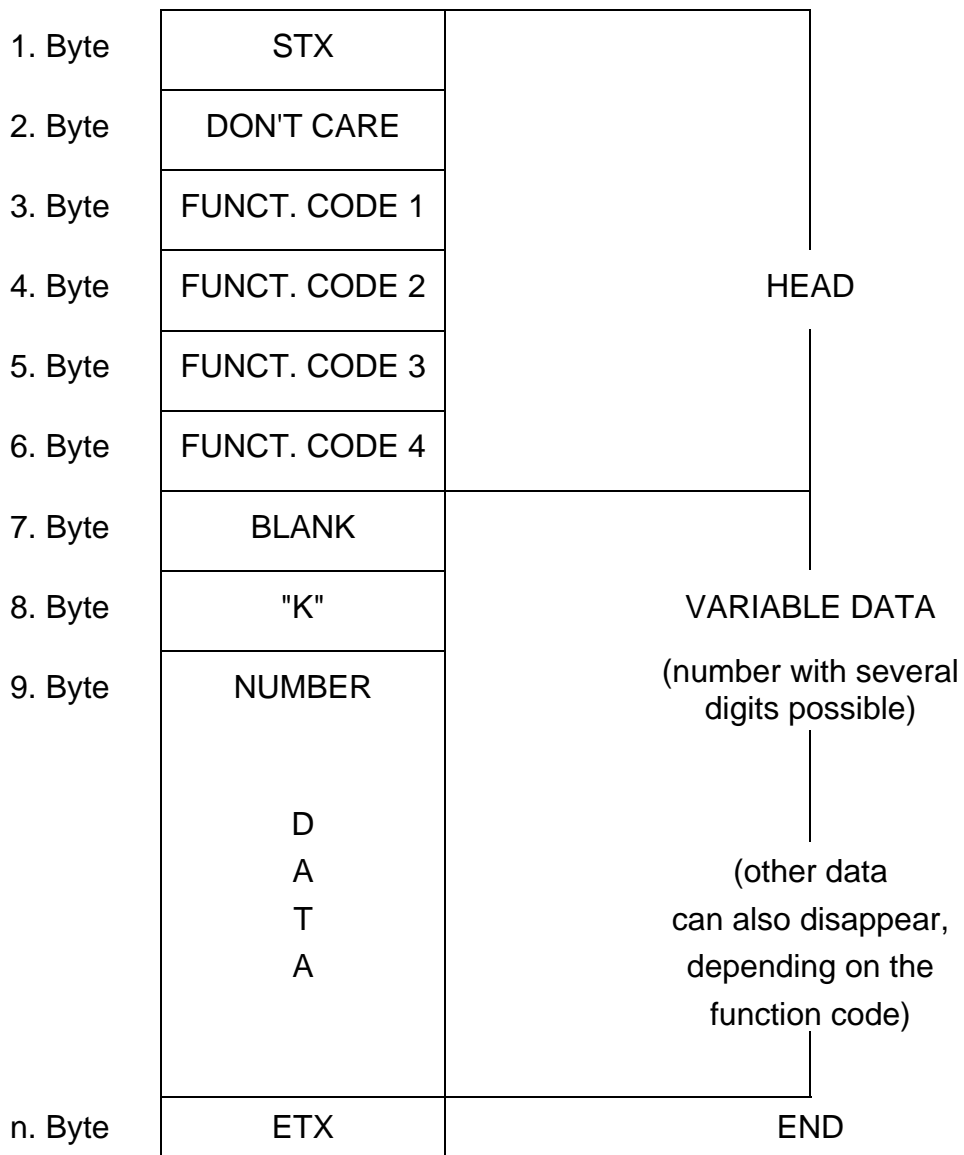

3.2. Response telegram

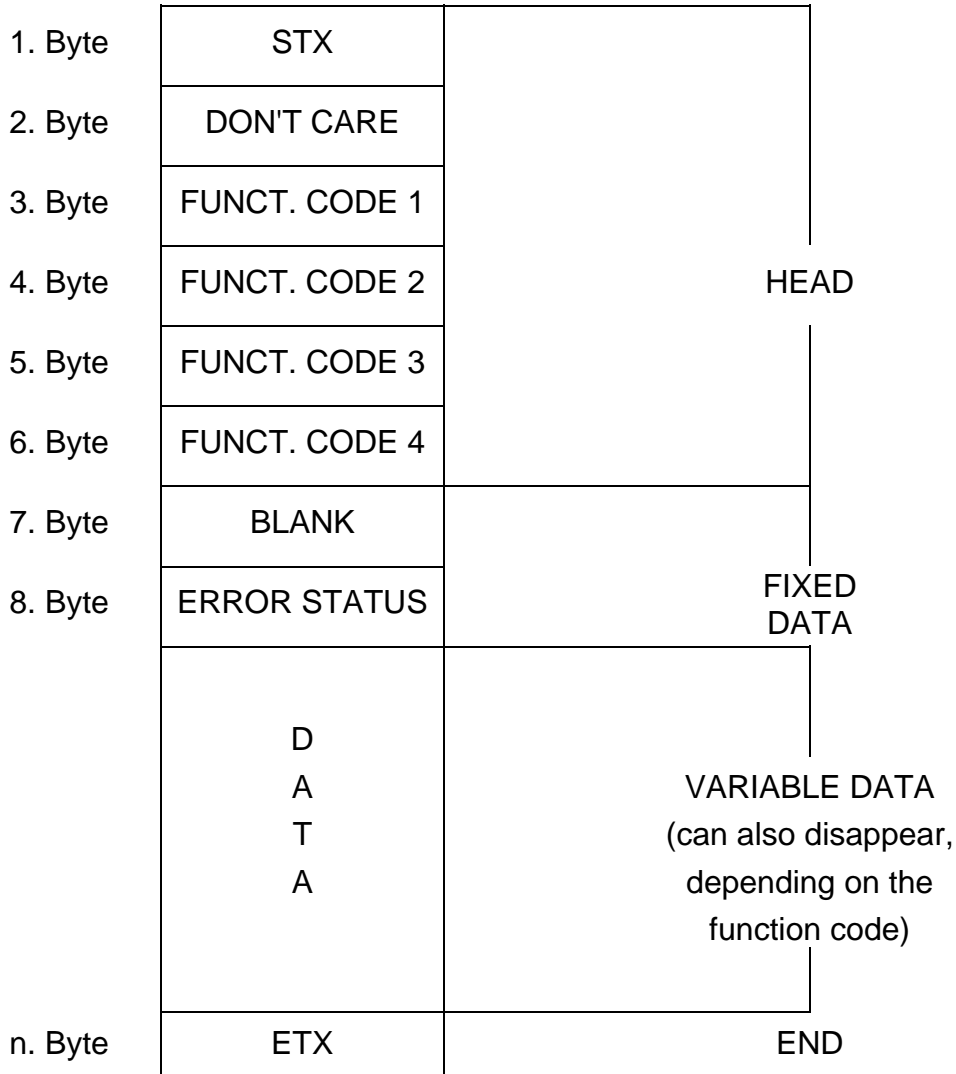

3.3. Command telegram for RS485 BUS operating

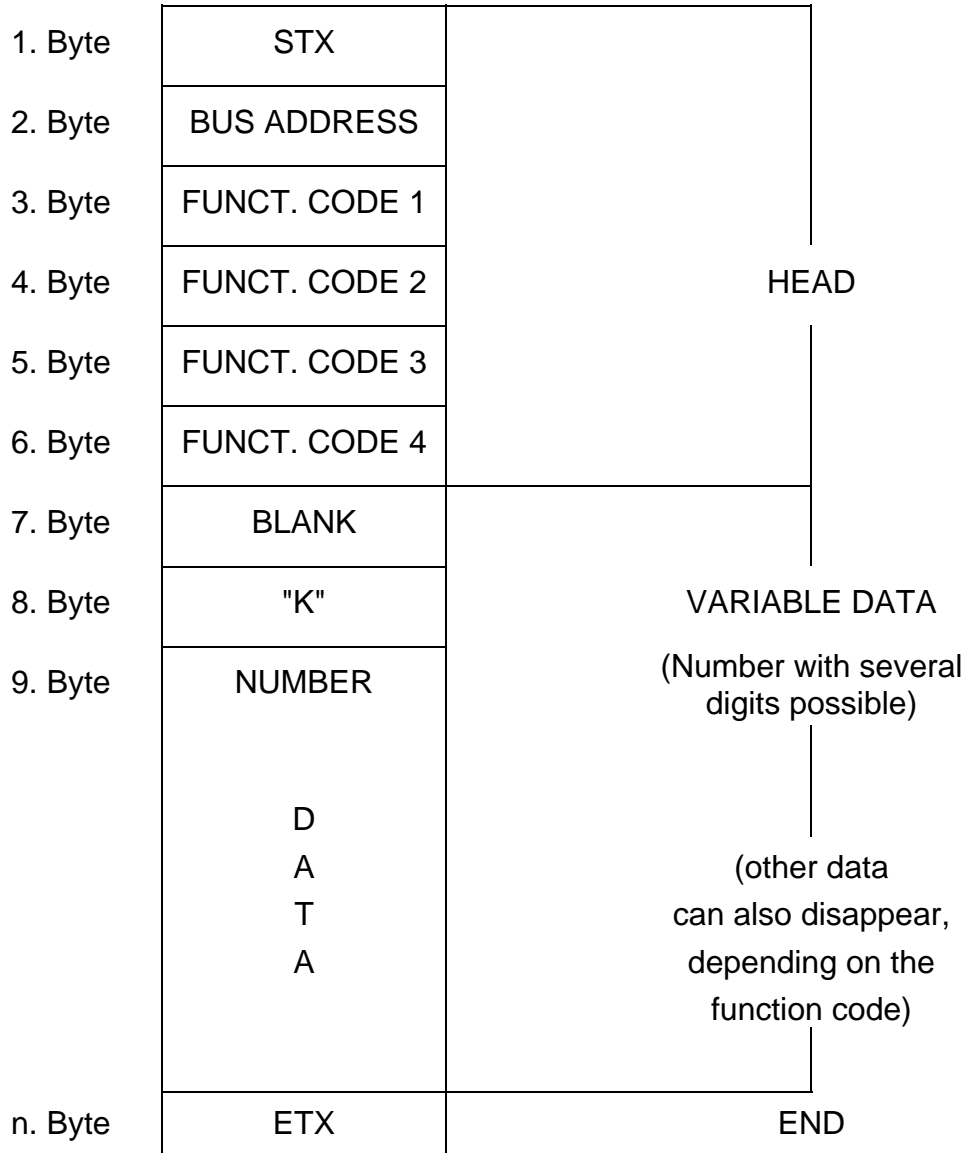

3.4. Response telegram for RS485 BUS operating

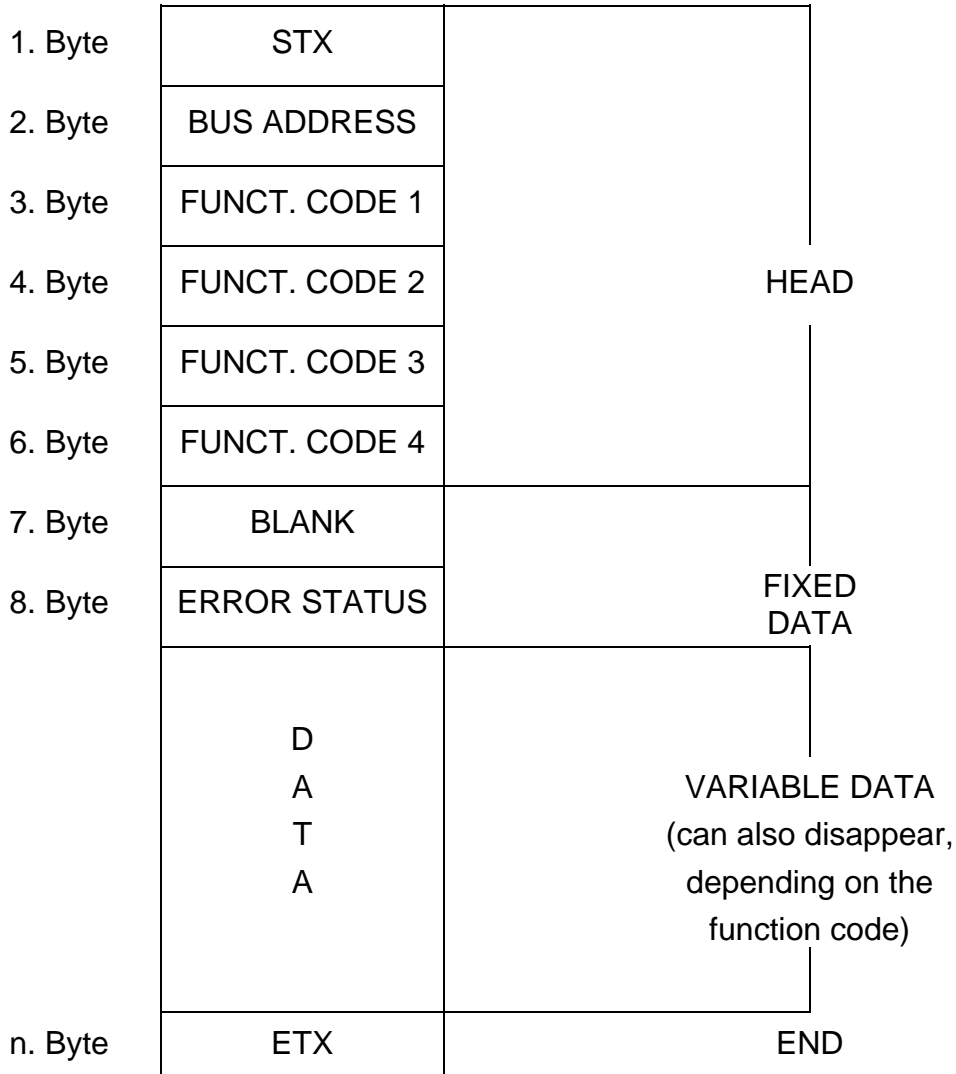

4. Specifications of data settings

4.1. Head telegram (Header)

The begin of each transfer is a "STX" in the first byte. Each "STX" will start a new transfer. Previous transfers will be deleted, if they are not finished by "ETX". That means, only completed telegrams may be interpreted and answered.

You can take any content for the "DON'T CARE" byte, excluding control signs or signs reserved by the AK commands.

For the RS485 BUS operating an address byte will be used instead of the "DON'T CARE" byte. The analyzers will only answer to this command if the bus address setup will concur with this byte.

In the command telegram a function code will be sent to the system unit or the analyzer with the four function bytes.

In the response telegram this function code will be sent back as an echo if the transfer is successful. The echo will be four question marks (????), if

- the command telegram has not minimum the number of bytes of the head telegram, the channel number in the data part and the end telegram (number of bytes = 10; using a channel number with two digits = 11 bytes) or
- the function code has errors or is unknown.

The function code may not contain blanks.

There are three groups of function codes:

- (1) Control commands
- (2) Read commands
- (3) Write commands

4.2. Data block and error status byte

The data presentation is variable. A fixed format will not be used. A blank or a <CR> with <LF> will be used as separating characters of data. The separation with <CR><LF> will only be done, if the following complete date will have more than 60 digits. Each data set will begin normally with a blank.

The data block of the command telegram has only variable data. These data depend on the function code. They can disappear for some function codes excluding the channel number. The channel number can have more than two bytes.

The data block of the response telegram is divided in fixed and variable data. The first digit of the fixed data is a blank followed by an error status byte. The error status number will be zero for an error free running analyzer or system unit. The error status number will be counted up from 1 to 9 with each change in the error status. The error status number will be zero again after the errors will be removed. Changing the status of the system will not change the error status number. The variable data depend on the function code. They can disappear for some function codes.

The long and variable floating point format or the E- Format are allowed to display the digits of numbers. You can find in each analyzer protocol which of these formats may be used. The decimal point can disappear for integers. The "+/-" sign may only be used for negative numbers. Digits without physical meaning have to be vanished.

You can distinguish the following cases if a date with an error exists for a reading:

- (1) The transfer of the date is not possible, e.g. an analyzer in a system is missing or it cannot send a signal.
→ The date will be replaced by a "#".
- (2) The date is only valid with restrictions, e.g. FID temperature too low.
→ The date will begin with a "#".
Range overflow and range underflow will be displayed in the same way. "Valid" means that no criterions of plausibility will be considered.
Example:
You ask for a concentration value and the analyzer is in the "stand-by" mode. The date must not be marked with "#" as "valid with restrictions", if the analyzer would work normally in the operation mode.

If an analyzer or a system is not in the "REMOTE" status, the control and write commands have to report "OF" ("Offline") in the data set to the. In system units the channel number has to be reported, too.

If one analyzer is missing, a system unit has to send the channel number and "NA" ("Not Available") to the test bench control computer with control and write commands.

A response telegram is not possible, if the test bench control computer has a direct contact to the analyzers and one analyzer is missing or the whole system is missing. So the test bench control computer has to realize the missing of devices by "Time Out".

If the system or the analyzer is occupied by executing a function, the new start of a control command will lead to the response "BS" (Busy) in the data block of the response telegram. The running function will not be disturbed. Exception: The order was a software reset.

If the data or parameters transfer is not complete (i.e. not expected format) in the command telegram to the system or the analyzer, the test bench control computer will get a "SE" (Syntax Error) in the data block of the following response telegram.

If the system or the analyzers cannot work with the data or the parameters of the command telegram (data error, parameter error), the test bench control computer will get a "DF" (data error) in the data block of the following response telegram.

4.3. End of telegram

Each transfer will end with "ETX" in the last byte.

4.4. Command and response telegram timing

For each command telegram of the TBCC the peripheral analyzer sends a response telegram.

It is not allowed for the TBCC to send new command telegrams before this response telegram is received.

For most of the command telegrams this response might be sent after some milliseconds. But for some commands the response telegram might be started to sent 2-3 seconds after receiving the command telegram. The time starts the moment the peripheral analyzer receives the ETX character of the command telegram.

It is not assured that the response telegram is sent without any delay between the single characters but it might be that there are up to 2-3 seconds in between.

4.5. Handling of malfunctions

For the case of a malfunction it might be that the ETX-character of the command telegram is not received by the peripheral analyzer. Then it will not evaluate the command telegram and so will not send a response telegram.

In this case it is in the responsibility of the TBCC not to run into an endless loop. It has to have a timeout of 4-5 seconds to react on this communication failure.

The TBCC may repeat the last command telegram or doing some other exception handling.

5. Examples for potential responses to control or write commands resp. to command telegrams with data (format) errors:

1. Analyzer and/or system unit with several analyzers "Online" and called analyzers are existing.

1. Byte	STX	
2. Byte	DON'T CARE	
3. Byte	C	
4. Byte	O	
5. Byte	D	
6. Byte	E	
7. Byte	BLANK	
8. Byte	x	Error status byte
	evtl. variable	
	...	
	.	
	...	
	Data	
n. Byte	ETX	

Error status byte: Value is zero: Device without error.
 Value is not zero: Device with one or more errors.

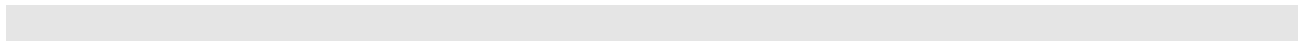

2. Analyzer and/or system unit with several analyzers "Offline" and called analyzers are existing.

1. Byte	STX	
2. Byte	DON'T CARE	
3. Byte	C	
4. Byte	O	
5. Byte	D	
6. Byte	E	
7. Byte	BLANK	
8. Byte	x	Error status byte
9. Byte	BLANK	
10. Byte	K	
11. Byte	n	
12. Byte	BLANK	
13. Byte	O	
14. Byte	F	
	evtl. variable	
	...	
	.	
	...	
	Data	
n. Byte	ETX	

Error status byte: Value is zero: Device without error.
Value is not zero: Device with one or more errors.
11. Byte: Channel number is zero: "The whole system unit offline".
Channel number is one to n: "Single analyzer offline".

3. Called system unit "online", called single analyzer not available.

If the test bench control computer will call the devices directly and the system unit or the analyzer are not available, you will not get any response telegram. So, the test bench control computer will have to realize the missing of the system or of the analyzer by "Time Out".

1. Byte	STX	
2. Byte	DON'T CARE	
3. Byte	C	
4. Byte	O	
5. Byte	D	
6. Byte	E	
7. Byte	BLANK	
8. Byte	x	Error status byte
9. Byte	BLANK	
10. Byte	K	
11. Byte	n	
12. Byte	BLANK	
13. Byte	N	
14. Byte	A	
15. Byte	ETX	

Error status byte: Value is zero: Device without error
Value is not zero: Device with one or more errors

11. Byte: Channel number one to n: "Called device not available".

4. Called system unit "offline", called single analyzer not available.

If the test bench control computer will call the devices directly and the system unit or the analyzer are not available, you will not get any response telegram. So, the test bench control computer will have to realize the missing of the system or of the analyzer by "Time Out".

1. Byte	STX	
2. Byte	DON'T CARE	
3. Byte	C	
4. Byte	O	
5. Byte	D	
6. Byte	E	
7. Byte	BLANK	
8. Byte	x	Error status byte
9. Byte	BLANK	
10. Byte	K	
11. Byte	0	
12. Byte	BLANK	
13. Byte	O	
14. Byte	F	
15. Byte	BLANK	
16. Byte	K	
17. Byte	n	
18. Byte	BLANK	
19. Byte	N	
20. Byte	A	
21. Byte	ETX	

I) V24/RS232/485-Interface - Basics

Error status byte: Value is zero: Device without error.
Value is not zero: Device with one or more errors.

11. Byte: Channel number zero: "System unit offline"

17. Byte: Channel number one to n: "Called device not available."

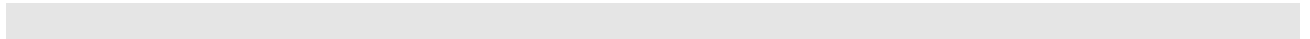

5. Called unit or channel is busy with a running function.

1. Byte	STX	
2. Byte	DON'T CARE	
3. Byte	C	
4. Byte	O	
5. Byte	D	
6. Byte	E	
7. Byte	BLANK	
8. Byte	x	Error status byte
9. Byte	BLANK	
10. Byte	K	
11. Byte	n	
12. Byte	BLANK	
13. Byte	B	
14. Byte	S	
15. Byte	ETX	

Error status byte: Value is zero: Device without error.
 Value is not zero: Device with one or more errors.

11. Byte: Channel number is zero: "The whole unit is busy".
 Channel number is one to n: "Single analyzer is busy".

6. The data are incomplete or the data do not have the expected format.
--

1. Byte	STX	
2. Byte	DON'T CARE	
3. Byte	C	
4. Byte	O	
5. Byte	D	
6. Byte	E	
7. Byte	BLANK	
8. Byte	x	Error status byte
9. Byte	BLANK	
10. Byte	K	
11. Byte	n	
12. Byte	BLANK	
13. Byte	S	
14. Byte	E	
15. Byte	ETX	

Error status byte: Value is zero: Device without error.
Value is not zero: Device with one or more errors.

7. The data or the parameters do not have the expected size.

1. Byte	STX	
2. Byte	DON'T CARE	
3. Byte	C	
4. Byte	O	
5. Byte	D	
6. Byte	E	
7. Byte	BLANK	
8. Byte	x	Error status byte
9. Byte	BLANK	
10. Byte	K	
11. Byte	n	
12. Byte	BLANK	
13. Byte	D	
14. Byte	F	
15. Byte	ETX	

Error status byte: Value is zero: Device without error.
 Value is not zero: Device with one or more errors.

6. Function sequence and error status after the receipt of the 'SRES' or 'STBY' commands

1. The test bench control computer is sending the control command SRES (Reset) to the system unit or any single analyzer.

All running functions or procedures will be canceled. An initializing will start, that is analogous to the switching on of the system unit or the analyzer: CPU and memory check, regulating or controlling of required temperatures, igniting of the flame in a FID and so on. The operation mode of the system or analyzer is "stand-by" during the initializing, even if the device is not ready and error free. That means, the status STBY will be reported to the read command ASTZ. The test bench control computer can only realize with the read command ASTF (error status), if the device is ready for measurements. The device will be ready to measure, if the essential functions of the current measuring instruction will be error free.

Example:

The status of the system unit or analyzer is SXYZ. The test bench control computer sends SRES:

Test bench control computer sends SRES Kn
→ System or analyzer will response SRES x

The system unit or the analyzer will cancel the status SXYZ. It will run a CPU and memory check and it will control the temperatures. If the temperatures are out of the allowed setpoint range, the device will regulate it. The FID will control the flame and will try to ignite it, if necessary, and so on. The test bench control computer will read the operation mode and the error status:

Test bench control computer sends ASTZ Kn
→ System or analyzer will response ASTZ 0 SMAN STBY

or

Test bench control computer sends ASTZ Kn
System or analyzer will response ASTZ x SMAN STBY

Test bench control computer sends ASTF Kn
System or analyzer will response ASTF x n

The error status byte will be zero and the system or the analyzer will be ready to measure, if all temperatures are in the allowed setpoint range, if the FID flame is burning etc.

If these parameters are not correct, the error status byte will be different from zero. The test bench control computer will read the operation mode and the error status as long as the system or the analyzer will be ready to measure. The test bench control computer will control the maximum time for this reading.

2. The test bench control computer is sending the control command STBY (Stand-by) to the system unit or any single analyzer.

There are two different cases:

- ☝ If the system or the analyzer is resting, this mode will be finished. Then, it will be tried to get the stand-by mode ready for an error free measurement. The system or the analyzer will regulate all temperatures to the required setpoints, that were down during the resting. The FID will control the flame burning and if necessary it will try to ignite the flame etc. The operation mode of the system or analyzer is "stand-by" during these checkups, even if the device is not ready and error free. That means, the status STBY will be reported to the read command ASTZ. The test bench control computer can only realize with the read command ASTF (error status), if the device is ready for measurements. The device will be ready to measure, if the essential functions of the current measuring instruction will be error free.

Example:

The system or the analyzer is resting. No error is existing. The test bench control computer will ask for the operation mode:

Test bench control computer sends ASTZ Kn

→ **System or analyzer will response ASTZ 0 SREM SPAU**

Test bench control computer sends STBY. System or analyzer shall accept the stand-by mode:

Test bench control computer sends STBY Kn

→ **System or analyzer will response STBY 0**

The system or analyzer is finishing the resting. Then, it will try to get the stand-by mode for an error free measurement. The system or analyzer will check the conditions: Are all temperatures in the setpoint range ? Is the FID flame burning ? etc. The test bench control computer will read the operation mode:

Status is error free:

Test bench control computer sends ASTZ Kn

→ **System or analyzer will response ASTZ 0 SREM STBY**

or status has still some errors:

Test bench control computer sends ASTZ Kn

→ **System or analyzer will response ASTZ x SREM STBY**

Test bench control computer sends ASTF Kn

→ **System or analyzer will response ASTF x n**

The error status byte will be zero and the system or the analyzer will be ready to measure, if all temperatures are in the allowed setpoint range, if the FID flame is burning etc.

If these parameters are not correct, the error status byte will be different from zero. The test bench control computer will read the operation mode and the error status as long as the system or the analyzer will be ready to measure. The test bench control computer will control the maximum time for this reading.

☞ The system or the analyzer is in the operation mode SXYZ. This mode will be finished. Then, it will be tried to get the stand-by mode ready for an error free measurement. If there will be an error in the function SXYZ, the system or the analyzer will try to remove this error to get the stand-by mode ready for an error free measurement (i.e. FID flame is not burning, the FID will try to ignite). The operation mode of the system or analyzer is "stand-by" during these check-ups, even if the device is not ready and error free. That means, the status STBY will be reported to the read command ASTZ. The test bench control computer can only realize with the read command ASTF (error status), if the device is ready for measurements. The device will be ready to measure, if the essential functions of the current measuring instruction will be error free.

Example:

The system or the analyzer is in the operation mode SXYZ. An error is existing with the error number n, i.e. FID flame is not burning. The test bench control computer will ask for the error status:

Test bench control computer sends ASTF Kn
→ System or analyzer will response ASTF x n

Test bench control computer sends STBY. System or analyzer shall accept the stand-by mode and get ready for an error free measurement:

Test bench control computer sends STBY Kn
→ System or analyzer will response STBY x

The system or analyzer is finishing the operation mode SXYZ. Then, it will try to get the stand-by mode for an error free measurement. The system or analyzer will check the conditions and will try to remove the error, i.e. ignition of the FID flame. The test bench control computer will read the operation mode:

Error is removed (e.g. Flame was ignited):

Test bench control computer sends ASTZ Kn
→ System or analyzer will response ASTZ 0 SREM STBY

or

Error is still existing (e.g. Flame has not been ignited):

Test bench control computer sends ASTZ Kn
→ System or analyzer will response ASTZ x SREM STBY

Test bench control computer sends ASTF Kn
→ System or analyzer will response ASTF x n

The error status byte will be zero and the system or the analyzer will be ready to measure, if the error is removed i.e. the FID flame is still burning.

If these parameters are not correct, the error status byte will be different from zero. The test bench control computer will read the operation mode and the error status as long as the system or the analyzer will be ready to measure. The test bench control computer will control the maximum time for this reading.

II) V24/RS232/485 Interface - Single Analyzers and Systems

Specifications of the criteria and codes for the communication between

- the front-end computer (system computer) of an exhaust analyzer system and the test bench control computer.
- each analyzer of an exhaust analyzer system and the test bench control computer.
- the front-end computer (system computer) of an exhaust analyzer system and their single devices. The following measurement systems and equipments can also be such single devices.
- the front-end computer (system computer) of a fuel consumption analyzer and a test bench control computer.
- the front-end computer (system computer) of an SHED measurement equipment and the test bench control computer. (SHED: Sealed Housing for Evaporative Determination)
- the front-end computer (system computer) of a sampling system and the test bench control computer.

The computer of an analyzer or of a system will be named as FU (Function Unit) and the test bench control computer will be abbreviated with TBCC.

1. Basic Informations

You can distinguish three cases:

(1) Exhaust analyzer system:

Some analyzers are combined logically. That means, these analyzers are connected with the TBCC via an front-end computer (system computer). The communication does not take place directly between the TBCC and the analyzers, but it will take place via the front-end computer. The identification of each device resp. of the whole system will be done by a channel number. K0 means the whole configured analyzer system ("assembling command resp. assembling report"). Kn (n=1, nmax) means each physical available analyzer. KV means the corresponding front-end computer.

Some analyzers and the sampling devices or systems (e.g. CVS equipment, particle sampler, sampling system, etc.) are combined logically. That means, these analyzers are connected with the TBCC via an front-end computer (system computer). The communication does not take place directly between the TBCC and the devices or systems, but it will take place via the front-end computer. The identification of each device and system will be done by a channel number. The handling of the analyzers will be like described above. All the other devices or systems can only be called directly by the corresponding channel number. The front-end computer must know the mnemonics of these devices and systems. Furthermore, the front-end computer has to be able to send orders and read commands to the channels resp. to send responses to the TBCC.

(2) Single exhaust analyzers (single channel analyzers):

All analyzers are connected to the TBCC individually. So, an identification of the analyzers by the software would not be necessary, because the analyzers are identified by their hardware connections. But to get a homogeneous protocol, the channel number will be indicated with K0.

(3) Single exhaust analyzers (multi channel analyzers):

All analyzers are connected to the TBCC individually, but they measure more than a single component (e.g. CO and CO₂). The identification by the software is necessary, because it will call the single channels resp. components. That is why such a single analyzer will be treated like a system.

II) V24/RS232/485 Interface - Single Analyzers and Systems

The codes determined in this manual are valid for the communication between

- the TBCC and the front-end computer of an exhaust analyzer system.
- the front-end computer of an exhaust analyzer system and the corresponding single devices.
- the TBCC and the single exhaust analyzers connected directly to the TBCC.
- the TBCC and other exhaust measuring or analyzing devices or equipments connected directly to the TBCC.

The floating point format is valid for the signal transfer.

The physical units are determined as follows:

- Exhaust values: ppm
- Temperatures: K
- Pressures: Pa
- Flow: l/min

The analyzer system or each analyzer can be set to the operation mode "MANUAL" selecting "REMOTE DISABLE" for the parameter "REMOTE EN-/DISABLE". This setup does not depend on the previous status of the system or analyzer.

If you select "REMOTE ENABLE", the mode "MANUAL" will retain for the moment, but the TBCC can call this operation mode with a control command. If the TBCC will setup the system/the analyzer to "REMOTE", the system/the analyzer will execute control commands from the TBCC. Precondition: The system/the analyzer is able to start the function selected.

In the mode "REMOTE DISABLE", the TBCC can only send read commands. It is only possible to read signals and status informations. If then the system or the analyzer is in the mode "MANUAL", it will ignore the control command from the TBCC. No change of the error status will be done in the response to the TBCC. Instead of that the response will display "MANUAL" as first date.

The same will be valid, if the parameter is "REMOTE ENABLE", but the TBCC did switch the system/the analyzer to the mode "MANUAL".

Otherwise, the operation mode can only be recognized by reading the status. This is also valid during a test is running.

If it is possible in a system to put single channels together to lines, so the following definition will be valid:

A line is the summary of "1-x" analyzers to a logical group "y", that can be switched physically to a gas channel "z". Each device can only be assigned to one line at the same time. If you will try to assign a channel to another line and this channel is already assigned, the front-end computer will send as response "DF" (data error).

The organization of each defined line will be done in the front-end computer (CODE KV Ln ...). The order must be sent to the front-end computer "KV".

A line will be dissolved by the configuration without assignment of channels (CODE KV Ln) or by the reset order (SRES).

All available gas inputs can be assigned to a defined line. So it is possible to assign different lines to different gas sampling points, e.g. in front of a catalyst, behind a catalyst. If the gas running time will change in such cases, you have to regard for it.

II) V24/RS232/485 Interface - Single Analyzers and Systems

2. List of all Codes

2.1. Control commands

CODE		Function	Page
SALI	Kn Mm	Linearization check with spangas	2 - 8
SARA	Kn	Autoranging "OFF" (located range will remain)	2 - 9
SARE	Kn	Autoranging "ON"	2 - 9
SATK	Kn	Autom. calibration (zero and span calibration + zerogas + stand-by)	2 - 10
SEGA	Kn	Spangas (spangas will flow with time limit)	2 - 15
SEMB	Kn Mm	Set range (1, 2, 3, 4)	2 - 16
SFRZ	Kn	Decimal point setup for floating point format	2 - 18
SGTS	Kn	Device test	2 - 19
SHDA	K0	Hold mode "OFF"	2 - 20
SHDE	K0	Hold mode "ON"	2 - 20
SINT	Kn	Start integration (integral average)	2 - 21
SLCH	Kn Mm	Linearization check (with gas distribution)	2 - 22
SLIN	Kn Mm	Linearization (with determination of corrections and saving)	2 - 23
SLST	Kn	Set linearization step and get values	2 - 24
SMAN	Kn	Operation mode "Manual"	2 - 25
SMGA	Kn	Samplegas (will be sucked or will be on)	2 - 26
SNAB	Kn	Zerogas calibration	2 - 27
SNGA	Kn	Zerogas (zerogas will flow with time limit)	2 - 28
SPAB	Kn	Spangas calibration	2 - 29
SPAU	Kn	Pause (resting status, e.g. pumps, ozonator, deozonator, high voltage off, gas input closed within the device)	2 - 30
SQEF	Kn Mm	Cross interference (only for CO analyzers)	2 - 31
SREM	Kn	Operation mode "Remote"	2 - 32
SRES	Kn	Reset (analyzer will change via initializing mode to stand-by)	2 - 33
SROF	Kn	Delay modus "OFF" (operation mode: signal output with/without delay time, involved are SINT, AKON, AIKO, AIKG, analog signal)	2 - 34
SRON	Kn	Delay modus "ON" (analog to "SROF")	2 - 34
SSPL	Kn	Purging (purge air will be sucked or will be on)	2 - 35
ST90	Kn	Set t_{90} time step (S = fast, M = medium, L = slowly)	2 - 36
STBY	Kn	Stand-by (get ready for measurement no matter of the previous history)	2 - 37
<u>Optional:</u>			
SCAL	Kn	Start system calibration (only for platform)	2 - 13
SENO	Kn	NO measurement (operation mode CLD)	2 - 17
SNOX	Kn	NO _x measurement (operation mode CLD)	2 - 17

Kn: Channel n

Mm: Range m

Response

The response to the control commands will contain the CODE of the control command and the error status byte (0-9).

2.2. Read commands

CODE		Function	Page
AAEG	Kn	Spangas deviation	2 - 39
AALI	Kn Mm	Deviations of the last linearization checks with spangas	2 - 40
AANG	Kn	Zerogas deviation	2 - 41
AEMB	Kn	Selected range (R1, R2, R3, R4)	2 - 45
AFDA	Kn CODE	Zero- /spangas time (function length of calibration)	2 - 46
AFDA	Kn CODE	Purge time	2 - 46
AGID	Kn	Device identification	2 - 47
AGRW	Kn m	Limit	2 - 48
AIKG	Kn	Concentration integral average; all (in ppm)	2 - 49
AIKO	Kn	Concentration integral average (in ppm)	2 - 51
AKAK	Kn Mm	Calibration gas concentration (in ppm)	2 - 53
AKAL	Kn	Stored calibration corrections	2 - 54
AKFG	Kn	Configuration of the system	2 - 57
AKON	Kn	Concentration (current value in ppm)	2 - 58
ALCH	Kn Mm	Deviations of the last linearization checks	2 - 61
ALIK	Kn	Calculation of linearization curve	2 - 62
ALIN	Kn Mm	Linearization values in the device (X/Y = Setpoint-/raw value)	2 - 63
ALKO	Kn Mm	Polynomial coefficients of the linearization curve	2 - 64
ALST	Kn	Linearization steps	2 - 65
AM90	Kn	Actual response time (t90 time)	2 - 66
AMBA	Kn Mm	Begin of range (in ppm)	2 - 67
AMBE	Kn Mm	End of range (in ppm)	2 - 68
AMBU	Kn	Switch levels for autoranging	2 - 69
AMDR	Kn	Manual adjusted pressure	2 - 70
AQEF	Kn	Cross interference check result (in ppm) (only for CO analyzers)	2 - 71
ASOL	Kn	Setpoint value with limits	2 - 72
ASTA	Kn	General status of the system	2 - 73
ASTF	Kn	Internal error status	2 - 74
ASTZ	Kn	Device status	2 - 76
ASYZ	Kn	System time (year, month, day, hour, min., sec.)	2 - 78
AT90	Kn	T90 time (response time)	2 - 79
ATEM	Kn m	Temperature	2 - 80
ATOL	Kn Mm	Stability tolerances	2 - 81
AVEZ	Kn	Delay and synchronization time	2 - 83
AZEI	Kn CODE	Times (for procedures)	2 - 84

Optional:

ABST	Kn	Counter of operating hours	2 - 42
ADRU	Kn m	Pressure (for service)	2 - 43
ADUF	Kn m	Flow (for service)	2 - 44
AKEN	Kn	Device tag	2 - 56
AKOW	Kn Mm	Correction (zerogas calibration and gradient)	2 - 60
AUKA	Kn	Uncorrected analog value	2 - 82

Kn: Channel n

Mm: Range m

Response

The response to the read command will contain the CODE of the read command, the error status byte (0-9) and the data.

II) V24/RS232/485 Interface - Single Analyzers and Systems

2.3. Write commands

CODE			Function	Page
EFDA	Kn	CODE DATA	Zero- /spangas time (function length of calibration)	2 - 85
EFDA	Kn	CODE	Purge time	2 - 85
EGRW	Kn	DATA	Limits	2 - 87
EKAK	Kn	Mm DATA	Calibration gas concentration (in ppm) Value = 0: no spangas available	2 - 88
EKFG	Kn	DATA	Configuration of the system	2 - 90
ELIN	Kn	Mm DATA	Linearization values in the device (X/Y = Setpoint-/raw value)	2 - 91
ELKO	Kn	DATA	Polynomial coefficients of the linearization curve	2 - 92
ELST	Kn	DATA	Linearization steps	2 - 93
EMBA	Kn	Mm DATA	Begin of range (in ppm) Value = 0: no range defined	2 - 94
EMBE	Kn	Mm DATA	End of range (in ppm) Value = 0: no range defined	2 - 95
EMBU	Kn	DATA	Switch levels for autoranging	2 - 96
EMDR	Kn	DATA	Manual adjusted pressure	2 - 97
ESOL	Kn	m DATA	Setpoint value with limits	2 - 98
ESYZ	Kn	DATA	System time (year, month, day, hour, min., sec.)	2 - 99
ET90	Kn	DATA	T90 time (response time)	2 -100
ETOL	Kn	Mm DATA	Stability tolerances	2 -101
EVEZ	Kn	DATA	Delay and synchronization time	2 -102
EZEI	Kn	CODE DATA	Times (for procedures)	2 -103
<u>Optional:</u>				
EKEN	Kn	DATA	Device tag	2 - 89

Kn: Channel n

Mm: Range m

Response

The response to the write commands will contain the CODE of the write command and the error status byte (0 - 9).

II) V24/RS232/485 Interface - Single Analyzers and Systems

SARA – Control command "Autoranging OFF"
SARE – Control command "Autoranging ON"

Starting the command "Autoranging ON" the analyzers in a system or the single analyzer will select the best range for the current concentration automatically. With the control command "SEMB" the autoranging will be stopped and the range sent with the "SEMB" command will be selected. The command "Autoranging OFF" will stop this function, but the found range will remain.

Control command

SARE K0
SARA K0

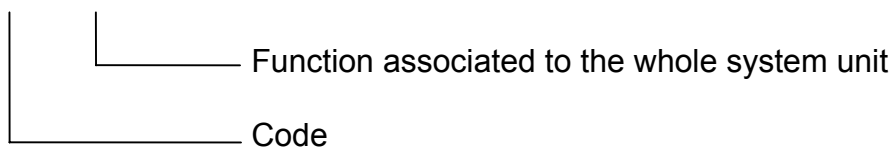

SARE Kn
SARA Kn

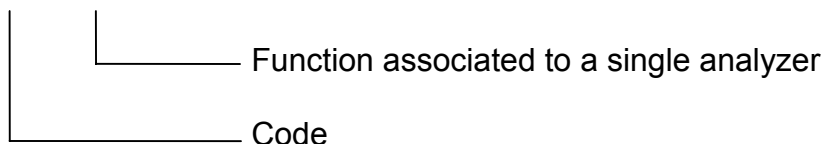

SATK – Control command "Automatic calibration"

Starting this command the analyzers in a system or the single analyzer will start a calibration procedure to determine the correction values. The required calibration gases and the pumps will be switched on automatically. Then, the calibration procedure will start automatically. Such a procedure has to run until the end. It may not be canceled or interrupted by other functions. Otherwise it is not sure that the correction values will be valid to calculate the exhaust values of analysis. Exceptions are the commands "Reset" or "Stand-by". After the procedure will be over the system, the analyzers in a system or the single analyzer will have to change to the operation mode "Stand-by".

Control command

SATK K0

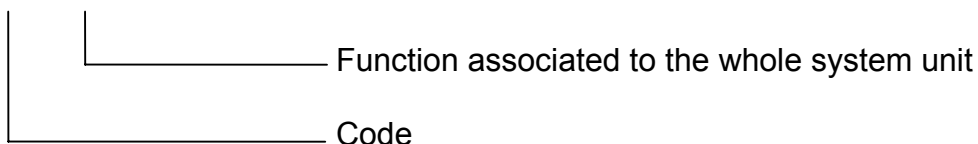

SATK K1 Kn

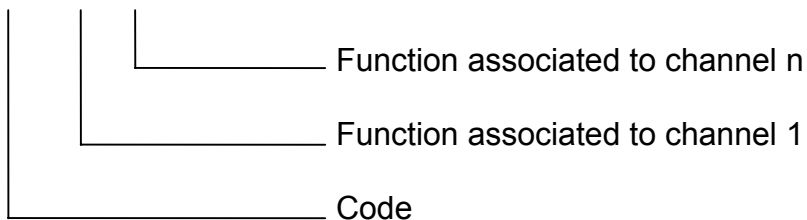

SATK Kn M3

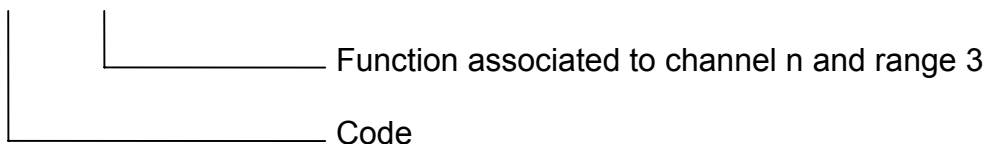

Response

SATK 0

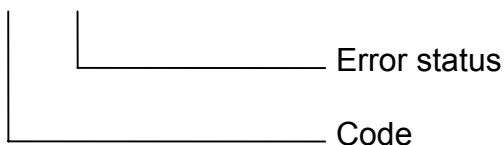

II) V24/RS232/485 Interface - Single Analyzers and Systems

Stability control procedure

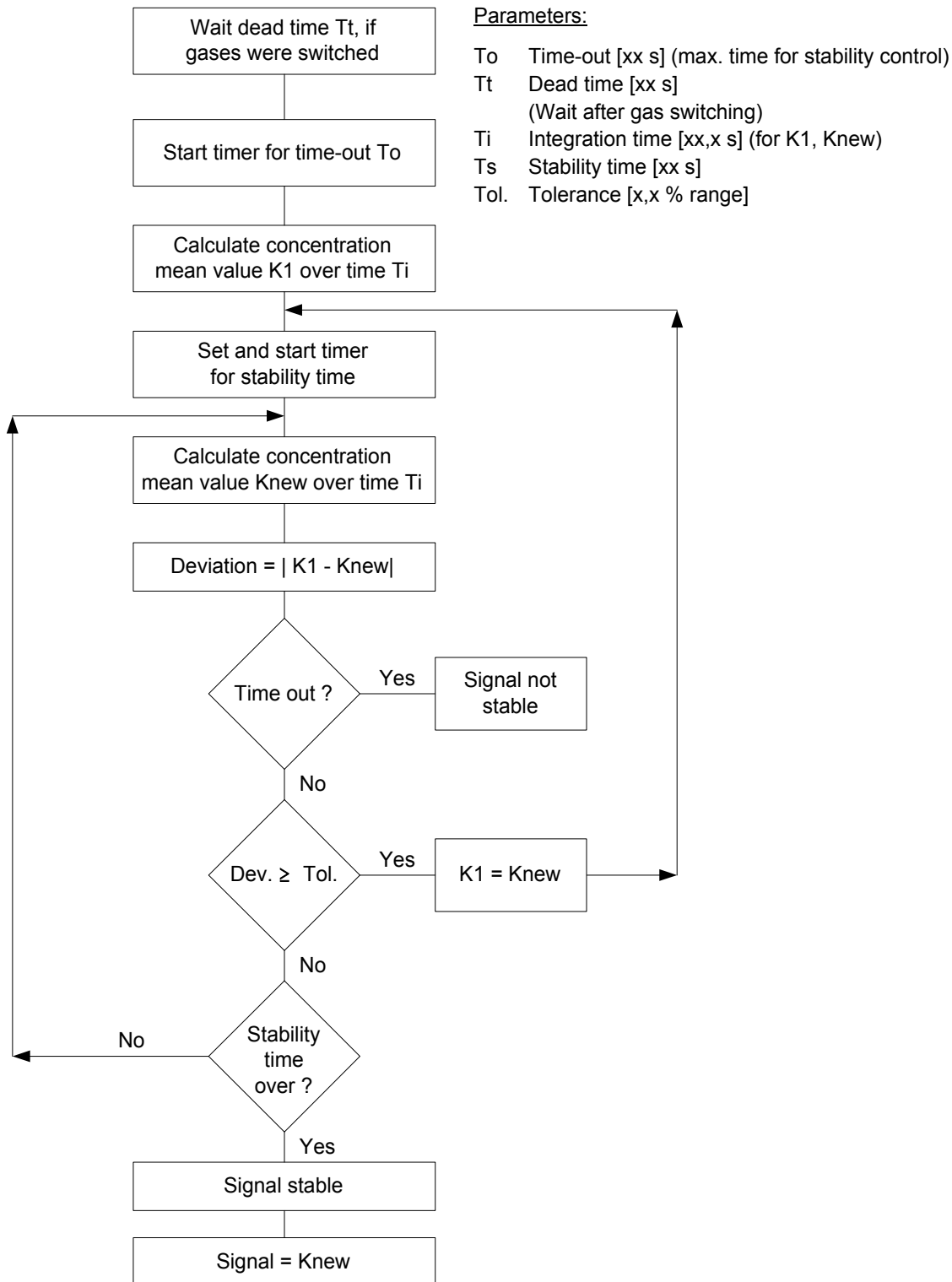

Stability control

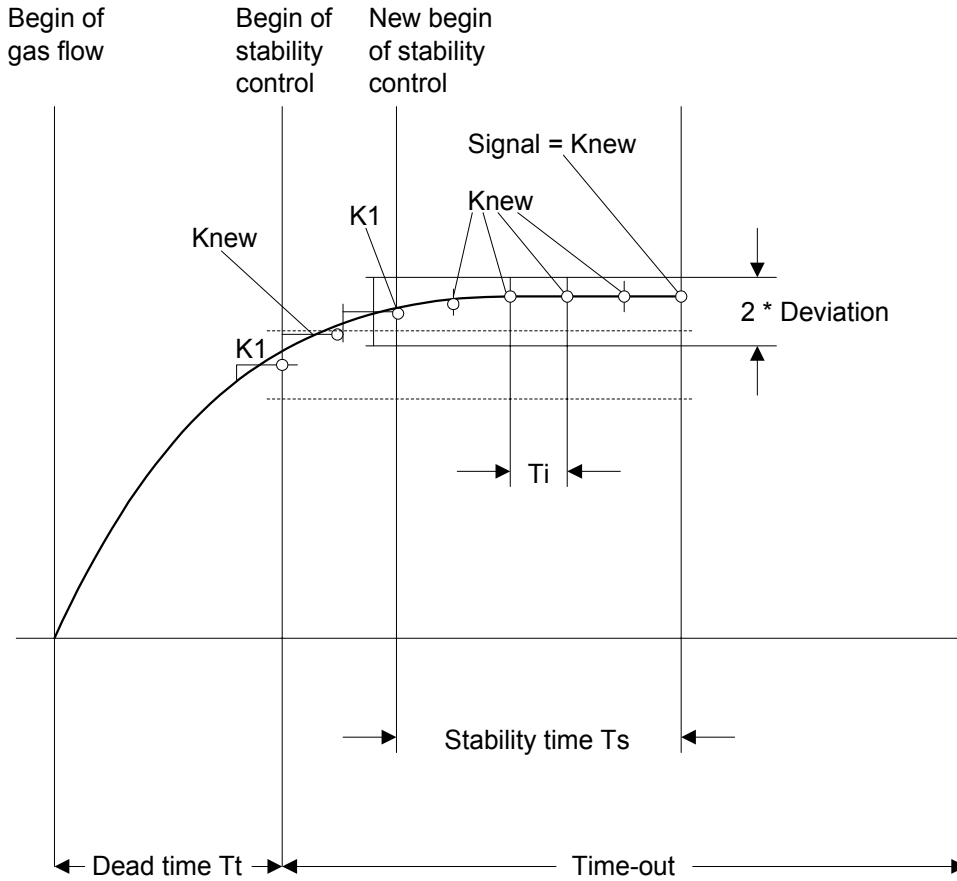

Stability controlled procedure of the zero/span calibration

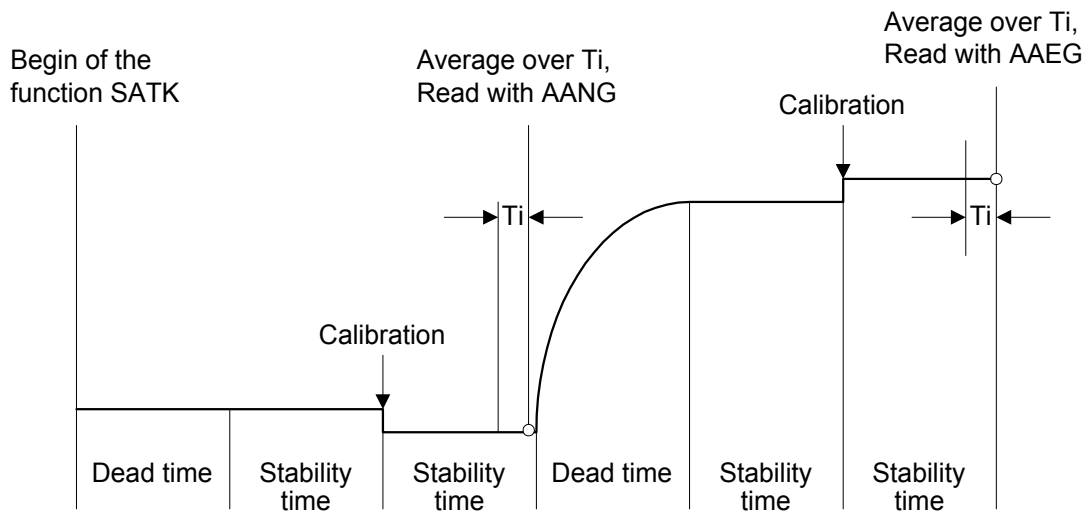

II) V24/RS232/485 Interface - Single Analyzers and Systems

Only for platform: SCAL – Control command "Start system calibration"

To control the system calibration procedures the commands "SCAL", "STBY" and "ASTZ" have to be used. With "SCAL" the procedures will be started. For more exact description of procedures see also the "documentation of system calibration".

Starting condition: All attached analyzer module are in the stand-by mode ("AK STBY") and the variable "CALSTAT" is "0".
Otherwise the response is "BUSY" (BS).

Control command

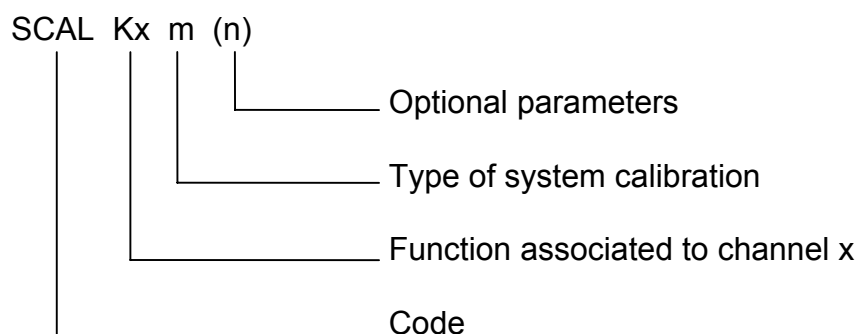

m	Kx	n
0 = ZERO-CAL	K0	n = 1: switch into test mode else: switch into normal mode
1 = ZERO/SPAN-CAL	K0	
2 = PROGRAM	K0	
3 = TEST ZERO-GAS	K1...999	time-out in sec
4 = TEST SPAN-GAS1	K1...999	time-out in sec
5 = TEST SPAN-GAS2	K1...999	time-out in sec
6 = TEST SPAN-GAS3	K1...999	time-out in sec
7 = TEST SPAN-GAS4	K1...999	time-out in sec
8 = TEST CLOSE GASES	K1...999	time-out in sec

If optional parameter "n" is not in the command string the appropriate variable will not be changed.

Stop command

STBY K0

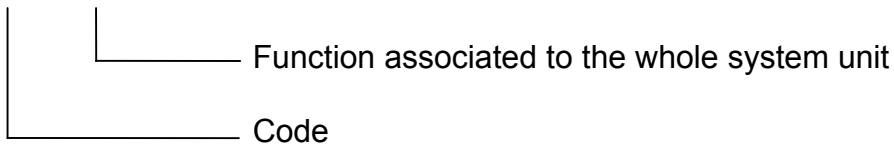

Only using the channel number 0 (K0) will stop running "SYSCAL" procedure. Besides, all procedures of the other analyzer modules will be stopped.

Response

SCAL 0

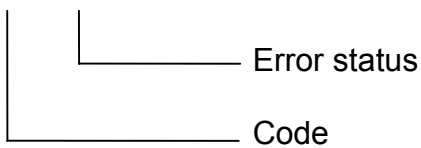

Read command

ASTZ K0

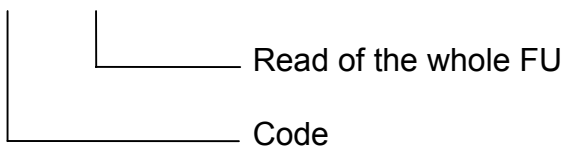

With the command "ASTZ K0" it will be checked, if a system calibration is running or not. "SCAL" will be sent back for a running system calibration. If no system calibration is running this string will be missed.

II) V24/RS232/485 Interface - Single Analyzers and Systems

SEGA – Control command "Spangas"

Starting this command the analyzers in a system or the single analyzer will switch on the calibration valve to spangas and switch on the required pumps. This function will only check the end point. It will not correct the calibration. If continuous line recorders will be available, the paper transport will also be switched on.

Control command

SEGA K0

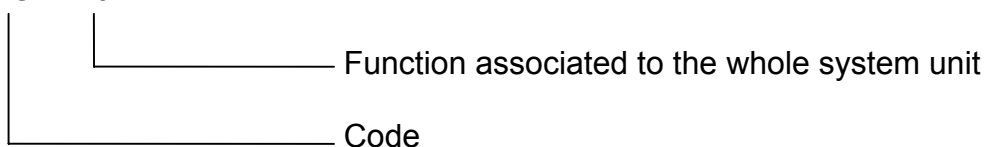

SEGA K1 Kn

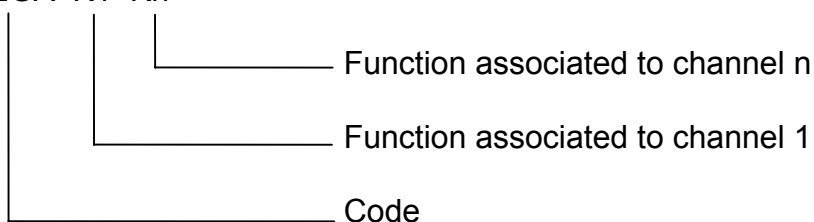

Response

SEGA 0

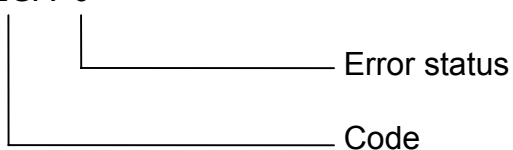

SEMB – Control command "Set range"

Starting this command the analyzers in a system or the single analyzer will set the range that is named in the data. If the function "Autoranging" is running at that moment, it will be stopped and the named range will be selected.

Control command

SEMB K1 M4 Kn M2

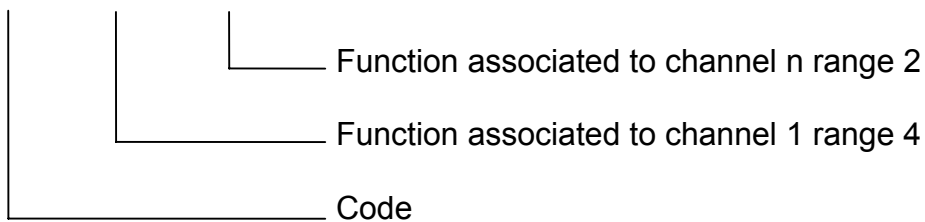

Response

SEMB 0

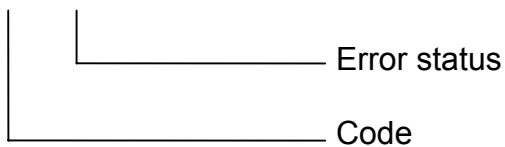

SFRZ – Control command "Decimal point setup for floating point format"

With this command the format of real numbers will be setup.

This command will have an effect to the output of all real numbers. It is not possible to vary it for different channels.

Control command

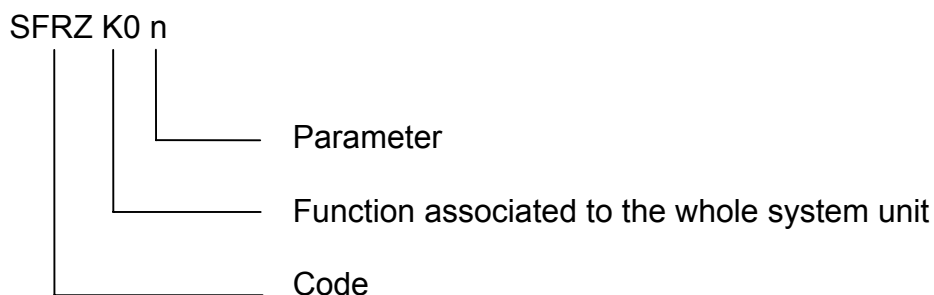

Description of parameter "n"

n = 1..9: n = number of digits after decimal point in normal floating point format.
(f-notation of C-language's printf)

n = 11..19: (n-10) = is the maximum number of significant digits of either normal floating point format or E-format, whichever is shorter.
(g-notation of C-language's printf).

Factory setting: n = 16 (= default).

Default is used if no other value for n is specified by a SFRZ command.

n = 10 will set n = default

Example:
Number: 1234567.821
n = 2 → 1234567.82
n = 13 → 1.23E06
n = 15 → 1234600

Response

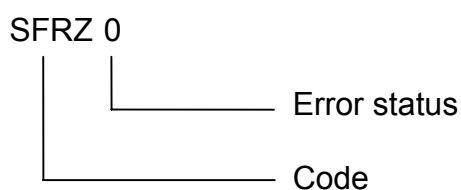

II) V24/RS232/485 Interface - Single Analyzers and Systems

SGTS – Control command "Device test"

Starting this command the analyzers in a system or the single analyzer will switch off the calibration gas and the sample gas. That means, all gas tubes to the analyzer device will be closed and the pumps will be switched off. Then, the device can be checked via a gas input that is located directly in front of the device.

Control command

SGTS K0

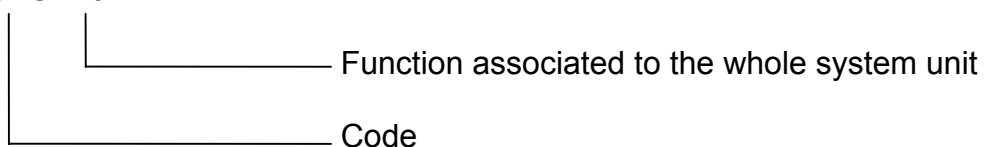

SGTS K1 Kn

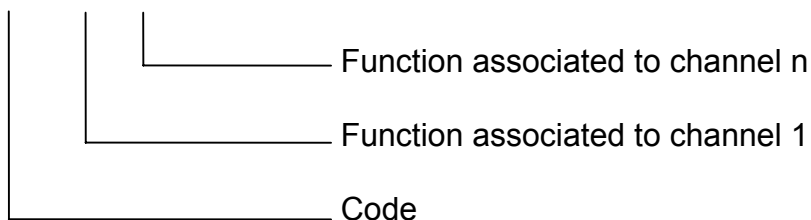

Response

SGTS 0

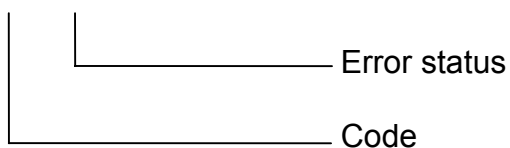

SHDE – Control command "Hold status ON"
SHDA – Control command "Hold status OFF"

We have the possibility to activate the "Hold"-feature not only per calibration. We can do this also by AK-Command "SHDE". With the command "SHDA" we have the possibility to deactivate an activated "Hold" again. Starting the command "SHDE" will switch on the "hold status". So it is possible to start the "Hold"-feature directly by AK command and not only per calibration. With the "SHDA" command the "Hold status" will be deactivated.

Control command

SHDE K0
SHDA K0

Function associated to the whole system unit

Code

Response

SHDE 0
SHDA 0

Error status

Code

II) V24/RS232/485 Interface - Single Analyzers and Systems

SINT – Control command "Integrator"

Starting this command the FU will activate the internal integrators. The previous calculated and stored integral averages will be set to zero. The integrator will calculate new integral averages as long as the control command "SINT" will be received again. The result of the integrator can be read with the command "AIKG".

Control command

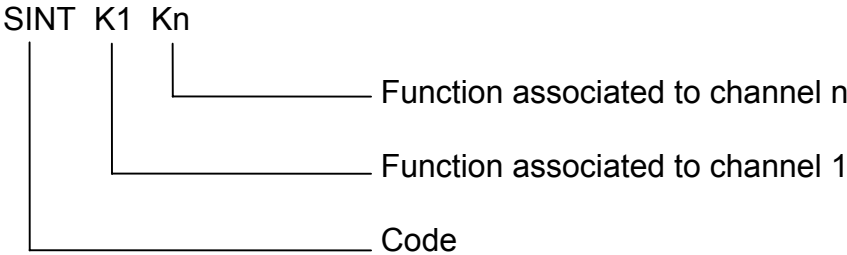
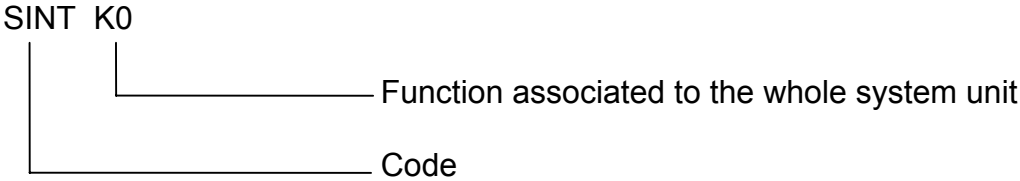

Response

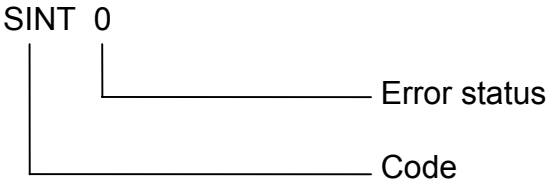

SLCH – Control command "Linearization check"

Starting this command the analyzers in a system or the single analyzer will switch on the gas tubing to a gas distribution and a linearization procedure will run. The device will record the correction values to the receiver specific raw curve. The deviations to the correction values of the last determined linearization will be stored. Look at the command "SLIN" for informations about the logic of the device control and of the gas distribution control.

Control command

SLCH Kn Mn

Range n

Function associated to channel n

Code

Response

SLCH 0

Error status

Code

SLIN – Control command "Linearization"

Starting this command the analyzers in a system or the single analyzer will switch on the gas tubing to a gas distribution. A linearization procedure for the selected range will run. The device will record the determined correction values to the receiver specific raw curve. The values will be stored in the device to calculate the gas concentration. This procedure will be controlled by several commands of the TBCC or the system. The device or the gas distribution will only accept those commands, if they have already received the "SLIN" command. The "SLIN" command prepares the device or the gas distribution to receive and execute further commands being necessary for the linearization procedure. The spangas concentration has to be set up before by the "EKAK" command.

Control command

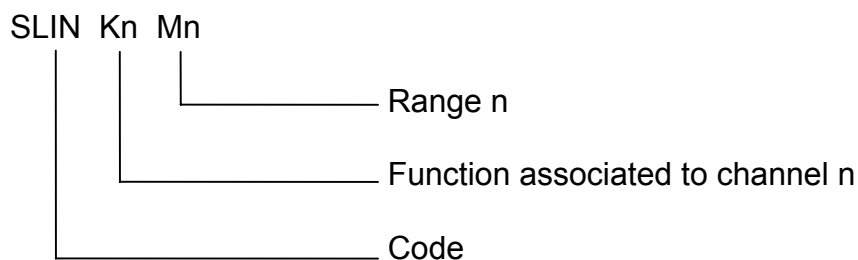

Response

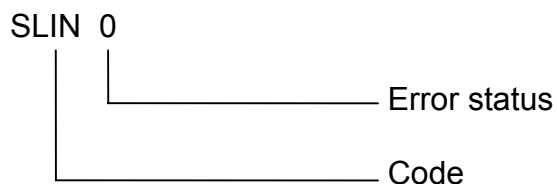

SLST – Control command "Set linearization step"

Starting this command the gas distribution will switch on the named distribution step. The device will work like described for the commands "SLIN" or "SLCH" depending on the current procedure. The device will only accept the "SLST" command, if the commands "SLIN" or "SLCH" were received before followed by the command "ELST".

Control command

SLST K1 n

Distribution step

Function associated to channel 1

Code

Response

SLST 0

Error status

Code

SMAN – Control command "Operation mode MANUAL"

With this command the FU will change to the operation mode "Manual". Then it will only be possible to start functions from an operating unit integrated in the FU. The same operation mode will be enabled, if the service switch of the FU will be in the position "Remote Disable". In that mode it will only be possible to answer to read commands of the TBCC.

Control command

SMAN K0

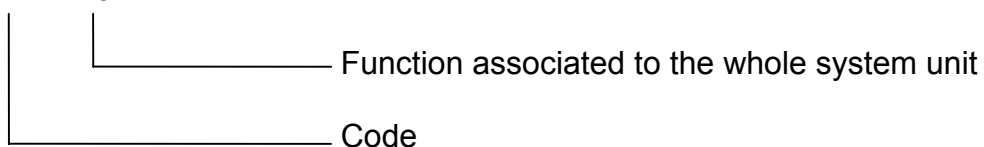

SMAN K1 Kn

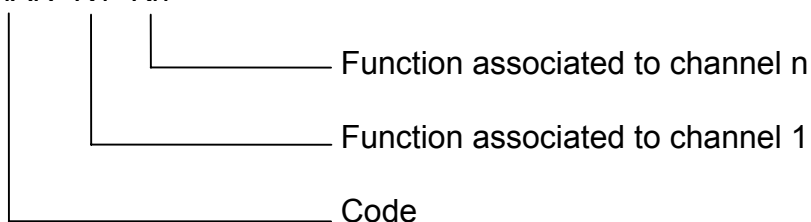

Response

SMAN 0

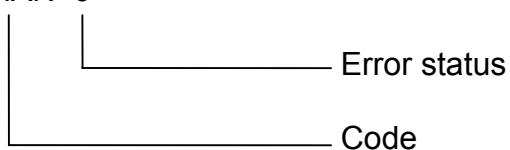

SMGA – Control command "Samplegas"

Starting this command the analyzers in a system or the single analyzer will switch on the sample gas valve and the pumps necessary for the samplegas transport. If continuous line recorders will be available, the paper transport will also be switched on.

Control command

SMGA K0

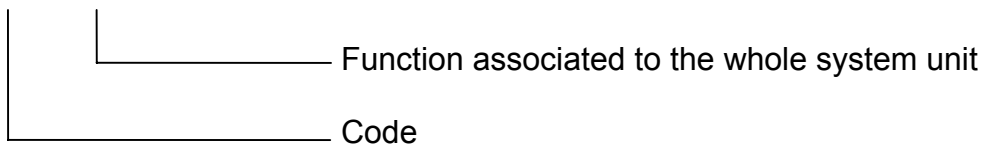

SMGA K1 Kn

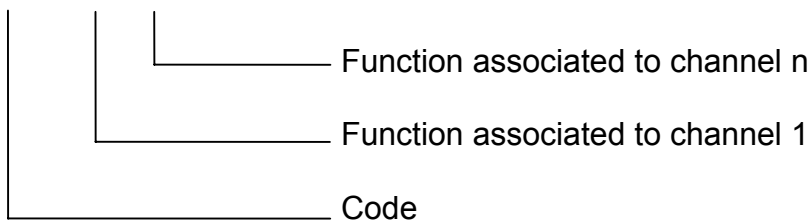

Response

SMGA 0

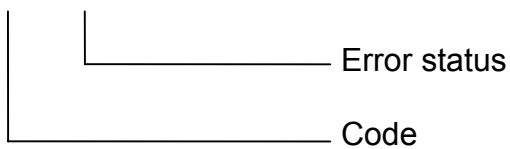

SNAB – Control command "Zerogas calibration"

Starting this command the analyzers in a system or the single analyzer will start a zerogas calibration. The calibration gas flow will start automatically and the calibration procedure will run. After this procedure will be over the system, the analyzer in a system or the single analyzer will change to the stand-by mode. The running calibration procedure can be canceled with the "STBY" command.

Control command

SNAB K0

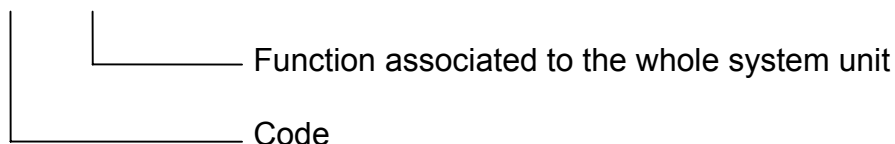

SNAB K1 Kn

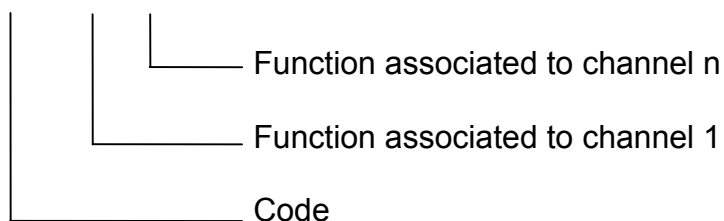

Response

SNAB 0

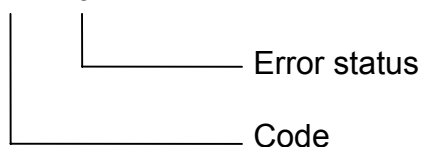

SNGA – Control command "Zerogas"

Starting this command the analyzers in a system or the single analyzer will switch on the zerogas valve and the pumps necessary for the zerogas transport. This function will only check the zero point. It will not correct the calibration. If continuous line recorders will be available, the paper transport will also be switched on.

Control command

SNGA K0

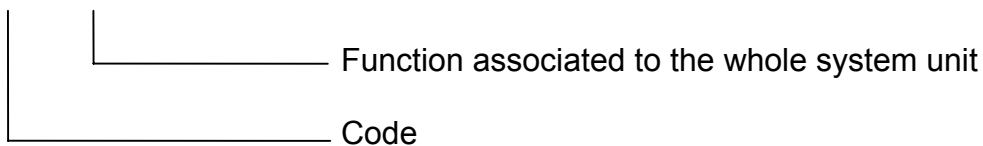

SNGA K1 Kn

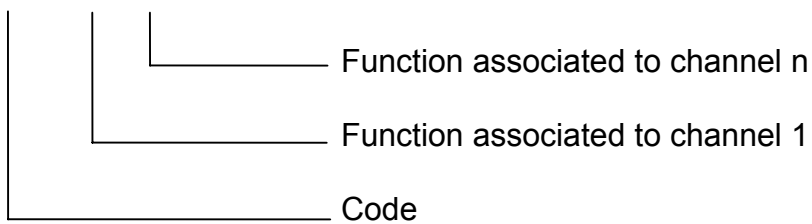

Response

SNGA 0

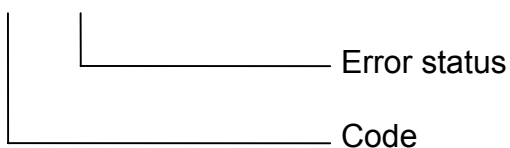

SPAB – Control command "Spangas calibration"

Starting this command the analyzers in a system or the single analyzer will start a spangas calibration. The calibration gas flow will start automatically and the calibration procedure will run. After this procedure will be over the system, the analyzer in a system or the single analyzer will change to the stand-by mode. The running calibration procedure can be canceled with the "STBY" command.

Control command

SPAB K0

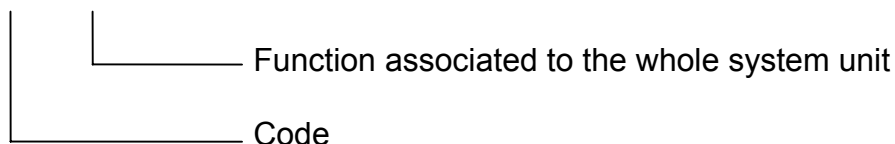

SPAB K1 Kn

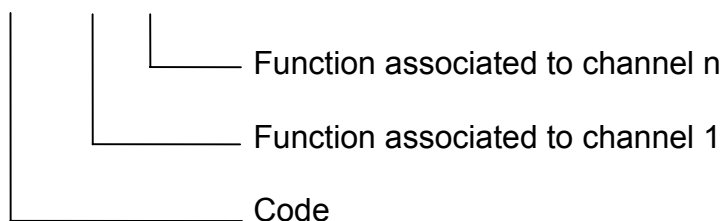

Response

SPAB 0

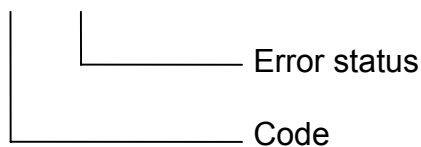

SPAU – Control command "Pause"

With this command the FU will be set to a defined status of interruption. This command will only be accepted, if the FU is already in the stand-by mode. The "SPAU" command will switch off the operation modes (e.g. FID flame, pump of an NO device) or the corresponding setpoints (e.g. temperature of the hot pipe). With the control command „Reset“ or „Stand-by“ the FU will change to the stand-by mode to get ready for operation. The real functionality of the "SPAU" command will depend on the used FU. It is part of each device or system specification.

Control command

SPAU K0

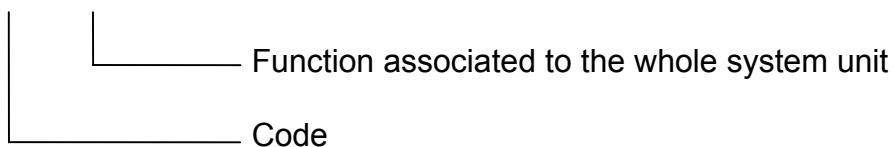

SPAU Kn

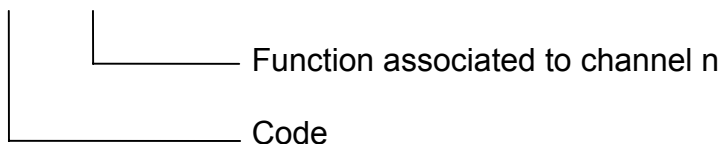

Response

SPAU 0

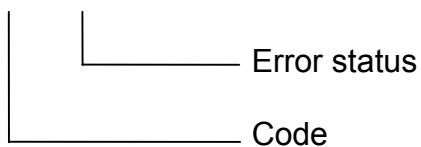

II) V24/RS232/485 Interface - Single Analyzers and Systems

SQEF – Control command "Cross interference"

Starting this command the CO analyzer will measure wet CO₂. It will be produced by streaming three percent CO₂ through water bottles at 20 degrees Celsius. The CO analyzer will measure this gas mixture. The signal will be stored in the analyzer. It can be read by the TBCC with the "AQEF" command. The measured concentration has to be maximum 3 ppm for ranges smaller than 300 ppm. For bigger ranges it has to be maximum 1 % of the end of range value. These limits will be controlled by the TBCC.

Control command

SQEF Kn
├── Function associated to channel n
└── Code

Response

SQEF 0
├── Error status
└── Code

SREM – Control command "Remote"

With this command the FU will change to the computing operation mode. Then, the function start will only be possible by the TBCC. This operation mode may only be set, if the service switch of the FU is in the position "Remote Enable".

Control command

SREM K0

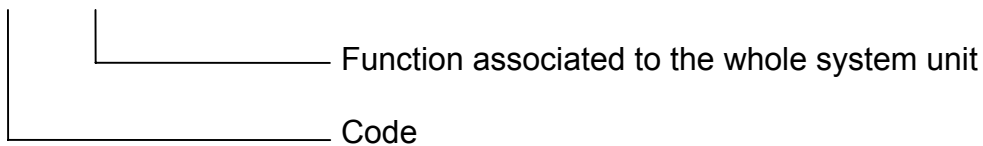

SREM K1 Kn

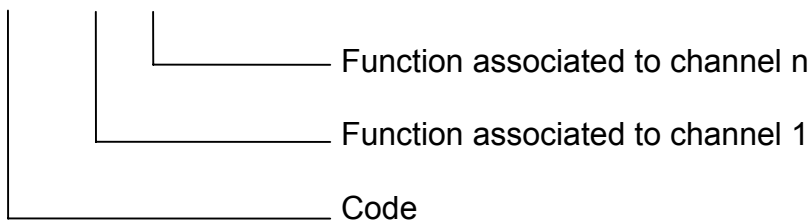

Response

SREM 0

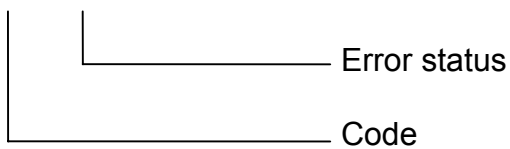

SRES – Control command "Reset"

With this command the FU will get a software reset. This command has the same effect to the FU like the switching off and on of the power supply. All running procedures will be canceled. An initializing will be started, e.g. check and control of temperature setpoints. After that the operation modes "Manual" and "Stand-by" will be enabled.

Control command

SRES K0

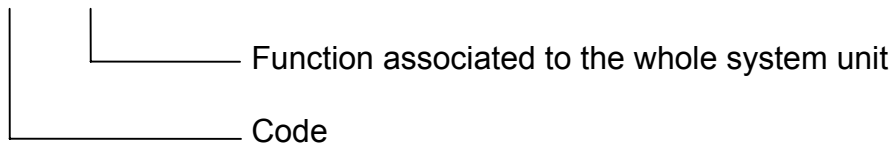

SRES Kn

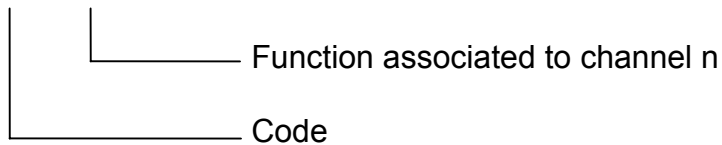

Response

SRES 0

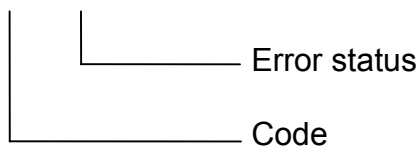

SRON – Control command "Delay modus ON"
SROF – Control command "Delay modus OFF"

Starting this command the analyzers in a system or the single analyzer will determine measurement and integral values (averages), that will be delayed according to the delay time of the write command "EVEZ". The read commands "AKON", "AIKO" and "AIKG" will get an old value according to the synchronization time of the command "EVEZ". The analog output will get the same delay. With the command "Delay modus OFF" the integrators will start immediately and the measurement and integral values will be determined and sent out without delay.

Control command

SRON K0
SROF K0

Function associated to the whole system unit
Code

SRON Kn
SROF Kn

Function associated to channel n
Code

Response

SRON 0
SROF 0

Error status
Code

SSPL – Control command "Purging"

Starting this command the analyzers in a system or the single analyzer will switch on the purge gas valve and the pumps necessary for the purge gas transport.

This function can be finished either by a new command or by a defined time interval. After the purging will be over the system, the analyzer in a system or the single analyzer will change to the stand-by mode.

Control command

SSPL K0

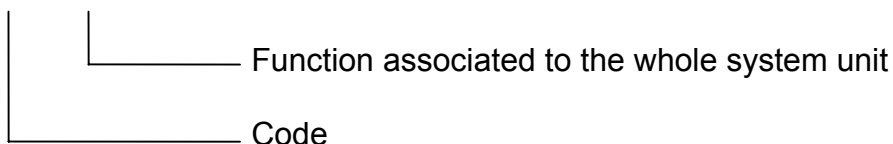

SSPL Kn

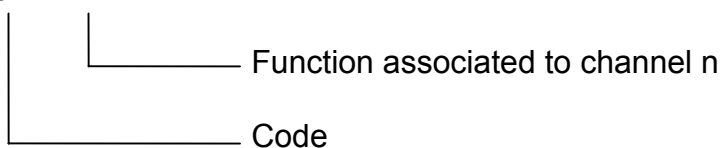

Response

SSPL 0

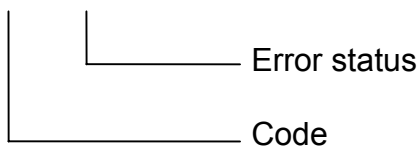

ST90 – Control command "Set t_{90} time step"

With this command the analyzer will use the t_{90} time according to the current step. The abbreviation "S" means fast time, "M" means medium time and "L" means slow time. After the switching on of the device or after a "Reset" the fastest time will be set.

Control command

ST90 K1 S

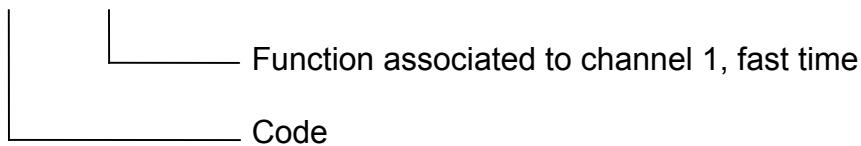

Response

ST90 0

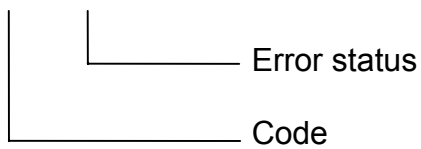

II) V24/RS232/485 Interface - Single Analyzers and Systems

STBY – Control command "Stand-by"

With the command "Stand-by" the FU will be set to a defined status of interruption. Running functions like measuring or purging will be canceled. Then, the stand-by mode will be enabled. The ranges will keep selected. The FU will get ready for measurement and operating, no matter which mode was the previous.

Control command

STBY Kn

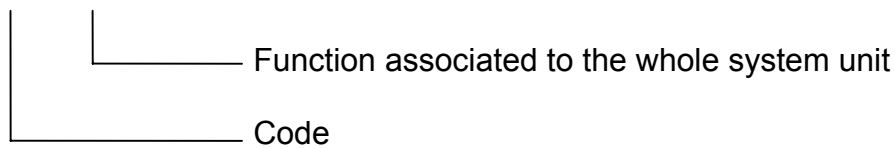

Response

STBY 0

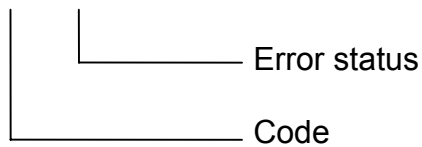

4. Description of all Read Commands

AAEG – Read command "Deviation to spangas"

To this read command the analyzers in a system or the single analyzer will send to the TBCC the following data for the called channel (device):

- * The measured and stored signal of the last spangas measurement.
- * The deviation from the setpoint value of the linearized curve in ppm and percent, referred to the end of range value.

Spangas measurement: Signal after the end of the functions "Automatic calibration" or "Spangas", stability controlled or time controlled depending on the setup in "EFDA".

Read command

AAEG K0

AAEG Kn

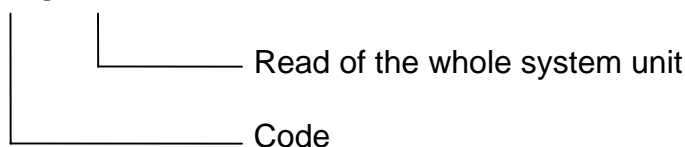

Response

AAEG 0 M1 XXX YYY ZZ ... Mn XXX YYY ZZ

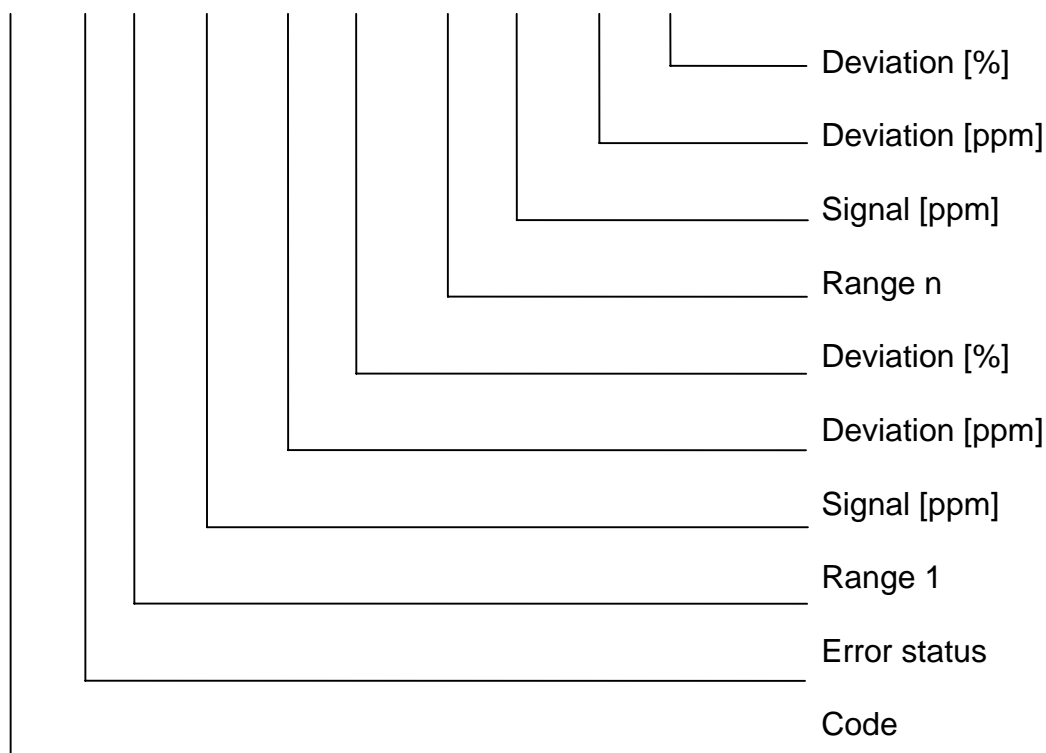

The values will get the same format for the read of single channels.

AAI – Read command "Deviations of the last linearization check with spangas"

To this read command the analyzers in a system or the single analyzer will send to the TBCC the following data for the called channel (device) and subchannel (range):

* The determined and stored deviations in ppm of the last linearization check with spangas.

Read command

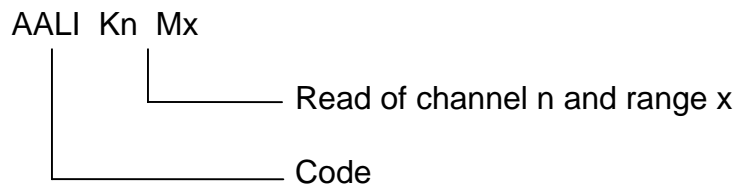

Response

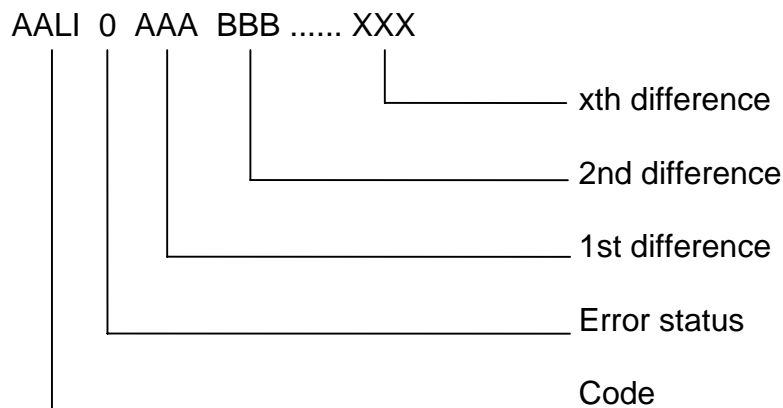

AANG – Read command "Deviation to zerogas"

To this read command the analyzers in a system or the single analyzer will send to the TBCC the following data for the called channel (device):

- * The determined and stored signal of the last zerogas measurement with its range.
- * The deviation from the setpoint value of the linearized curve in ppm and percent, referred to the end of range value.

Zerogas measurement: Signal after the end of the functions "Automatic calibration" or "Zerogas", stability controlled or time controlled depending on the setup in "EFDA".

Read command

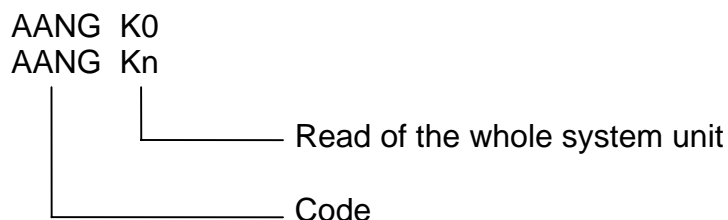

Response

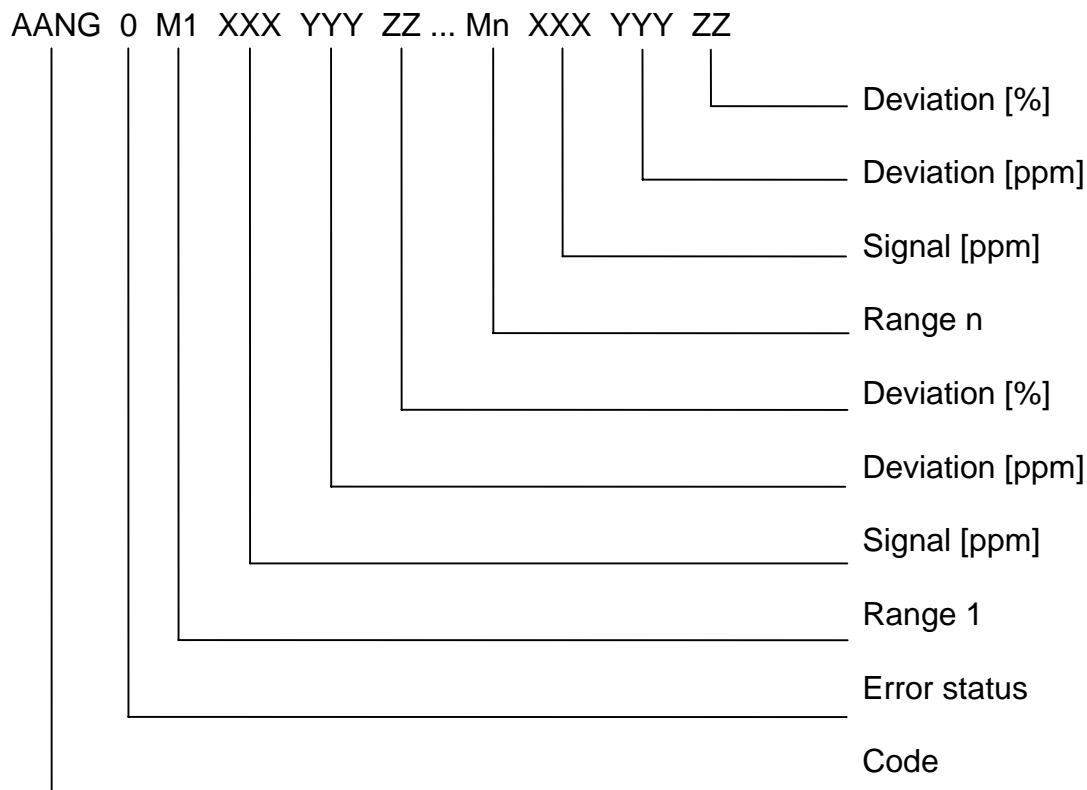

The values will get the same format for the read of single channels.

ABST – Read command "Counter of operating hours"

To this read command the FU will send to the TBCC the following data:

- * The operating hours until now for the roots fan, the turbo compressor, the sampling pumps etc. The operating hours will only be sent as integers.

Read command

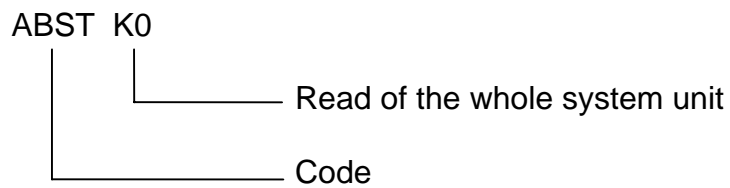

Response

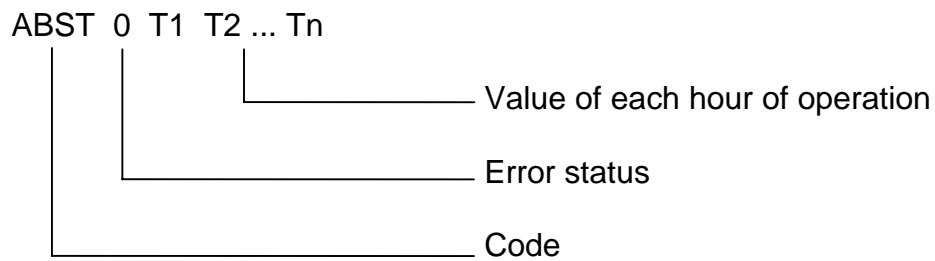

II) V24/RS232/485 Interface - Single Analyzers and Systems

ADRU – Read command "Pressure"

To this read command the analyzers in a system or the single analyzer will send to the TBCC the following data for the called channel (device) and if need be for the subchannel (pressure measurement):

* The signal in Pascal.

Note: At the moment no subchannels will be used.

Read command

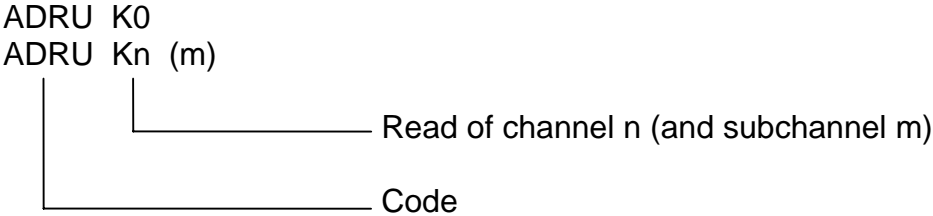

Response

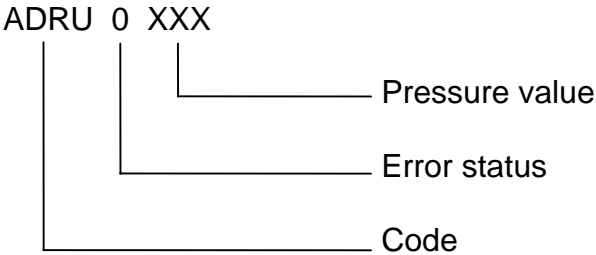

ADUF – Read command "Flow"

To this read command the analyzers in a system or the single analyzer will send to the TBCC the following data for the called channel (device) and subchannel (flow measurement):

* The signal in liter per time unit.

Read command

ADUF K0

ADUF Kn (m)

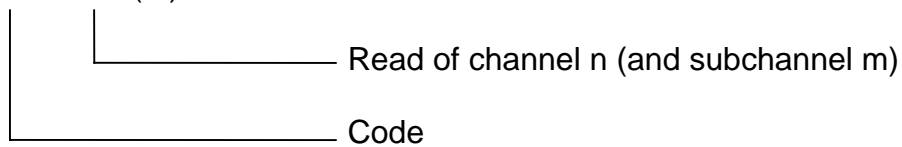

Response

ADUF 0 XXX

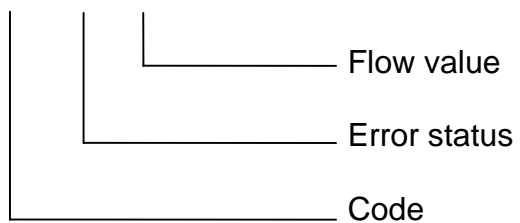

AEMB – Read command "Selected range"

To this read command the analyzers in a system or the single analyzer will send to the TBCC the following data for the called channel (device):

- * The selected and used range at this moment.

Read command

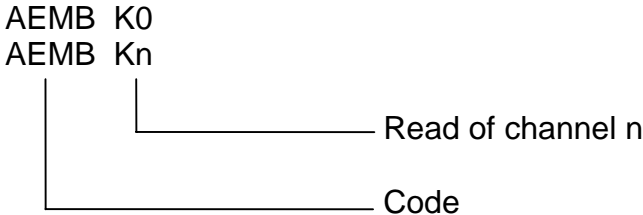

Response

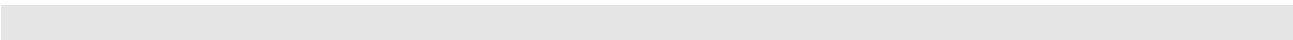
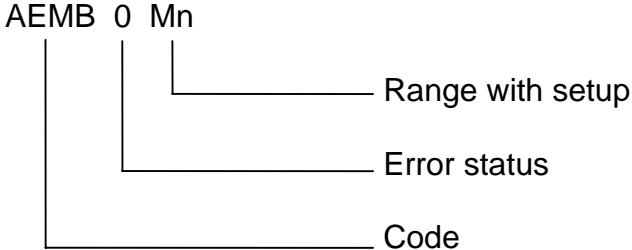

AFDA – Read command "Function length"

To this read command the FU will send to the TBCC the following data for the called channel (device):

* The function or procedure times of the function determined in "CODE".

Functions like "SATK", "SLIN", "SLCH", "SALI", "SQEF", "SNGA" or "SEGA" will run time controlled according to the times T1 to T4 or stability controlled.

Time control: If only T1 is set or if T2 = 0, time control will run with step time T1 (total function time).

Stability control: Times T1 to T4 have to be set.

Read command

AFDA K0 CODE

AFDA Kn CODE

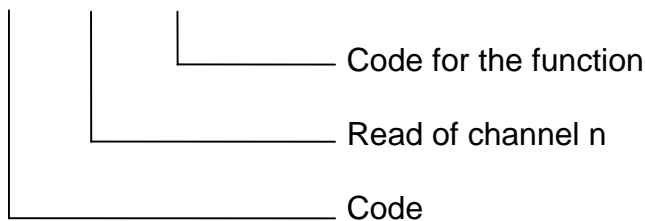

Response

AFDA 0 T1 (T2 T3 T4)

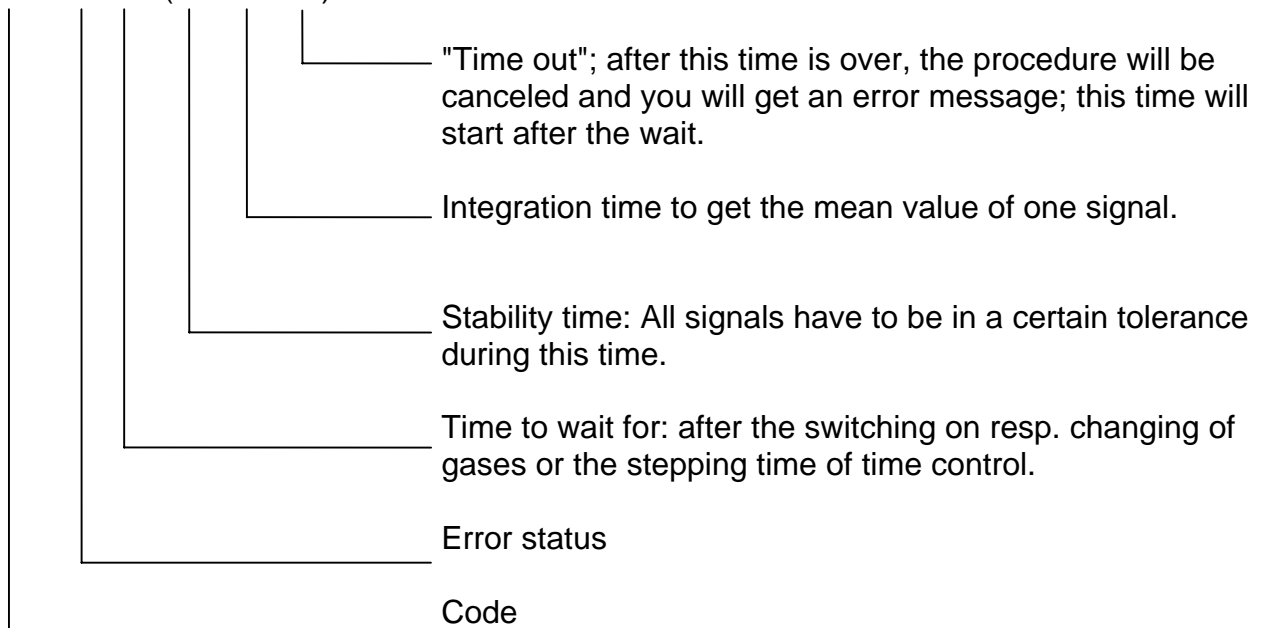

II) V24/RS232/485 Interface - Single Analyzers and Systems

AGID – Read command "Device identification"

To this read command the gas analyzer will send to the TBCC a text string consisting of several data. These data will be separated by a slash (/).

Read command

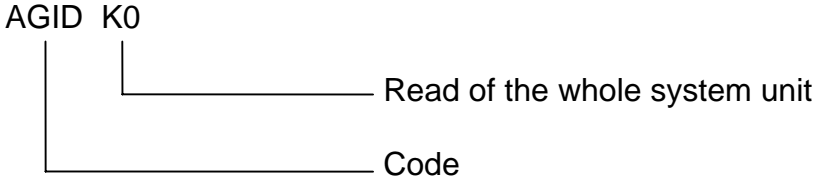

Response

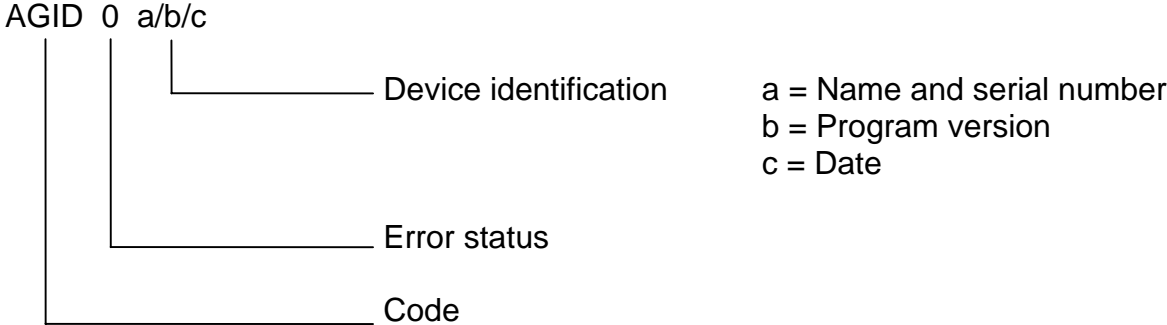

AGRW – Read command "Limits"

To this read command the analyzers in a system or the single analyzer will send to the TBCC the following data for the called channel (device):

* The corresponding limits, e.g. maximum deviations of calibration.

Read command

AGRW K0 m

AGRW Kn m

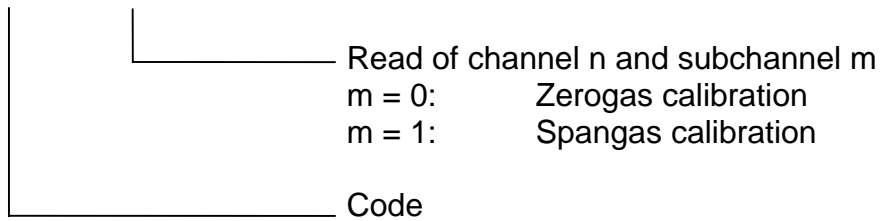

Response

AGRW 0 XXX

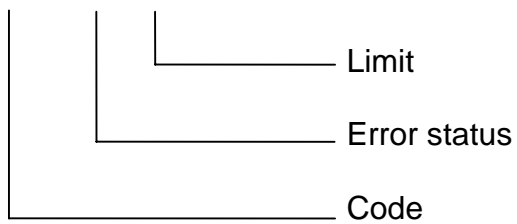

AIKG – Read command "Concentration integral value; all"

To this read command the FU will send to the TBCC the following data:

- * The corrected average signal valid at that moment (e.g. analyzed value), that has been calculated since the last "SINT" command. The physical parameter is described in the section about FU. The value will be limited to six relevant digits, because it is useless to send gas concentrations in an accuracy less than pars pro mille. Look at the example of the "AKON" command !

Cf. the "SFRZ" command !

Read command

AIKG K0

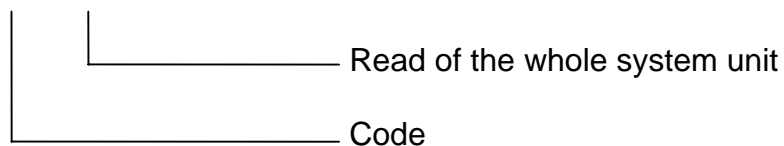

AIKG K1 ... Kn

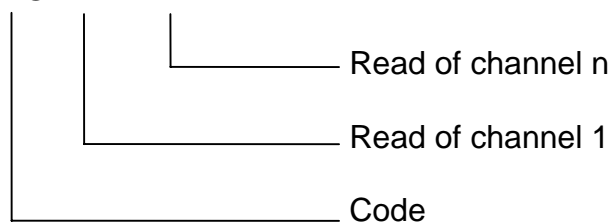

Response

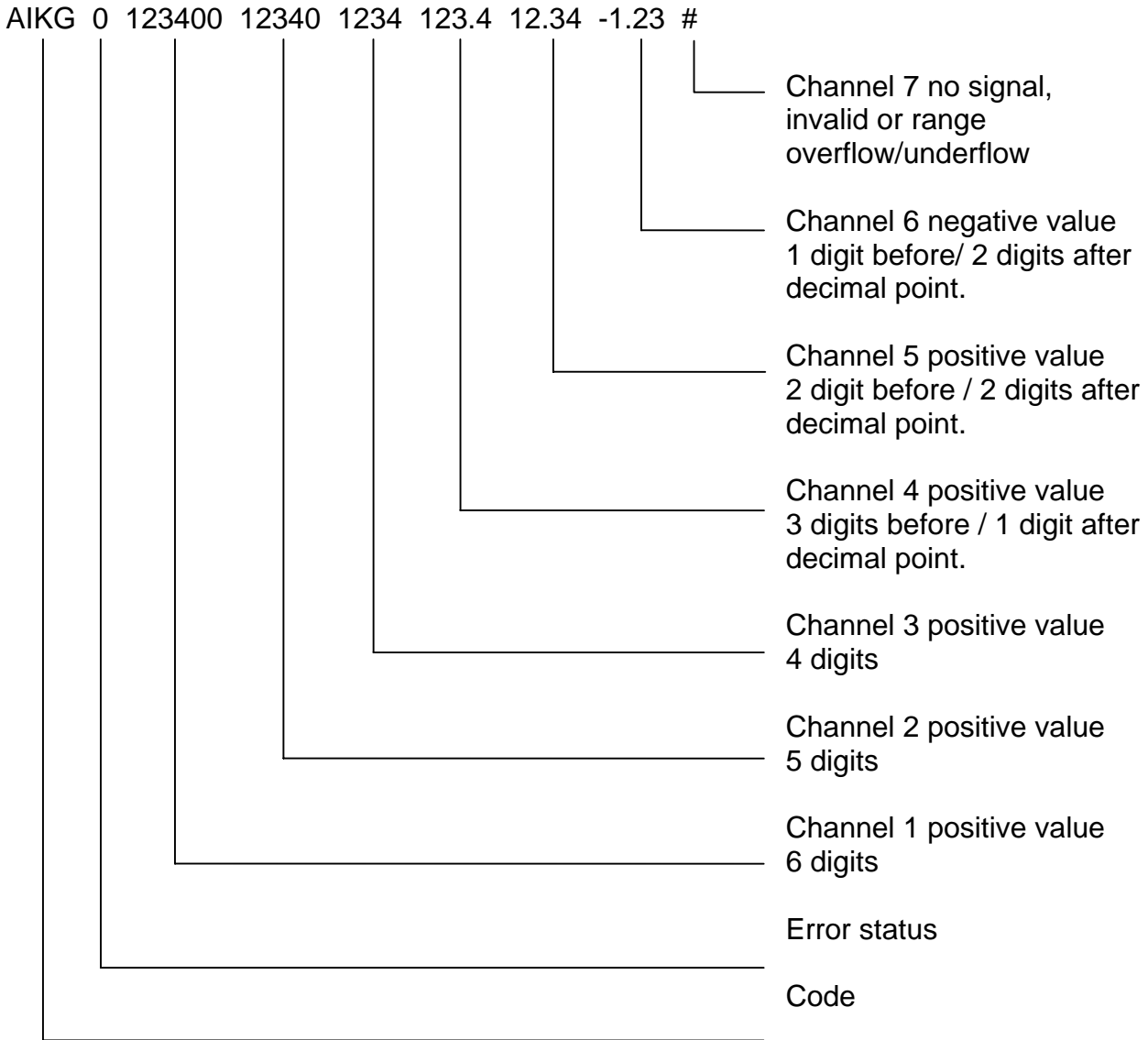

The values will get the same format for the read of single channels.

AIKO – Read command "Concentration integral value"

To this read command the FU will send to the TBCC the following data:

- * The corrected average signal valid at that moment (e.g. analyzed value), that has been calculated since the last "SINT" command resp. the last "AIKO" command. The physical parameter is described in the section about FU. The value will be limited to six relevant digits, because it is useless to send gas concentrations in an accuracy less than pars pro mille. Look at the example of the "AKON" command !

Read command

AIKO K0

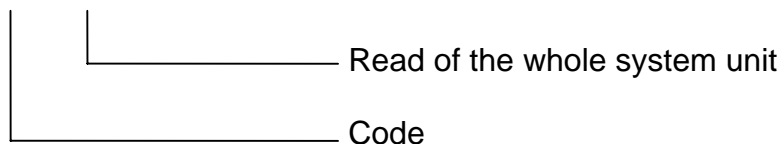

AIKO K1 ... Kn

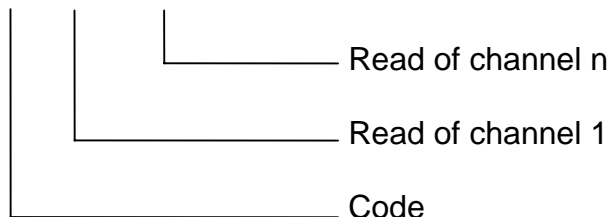

Response

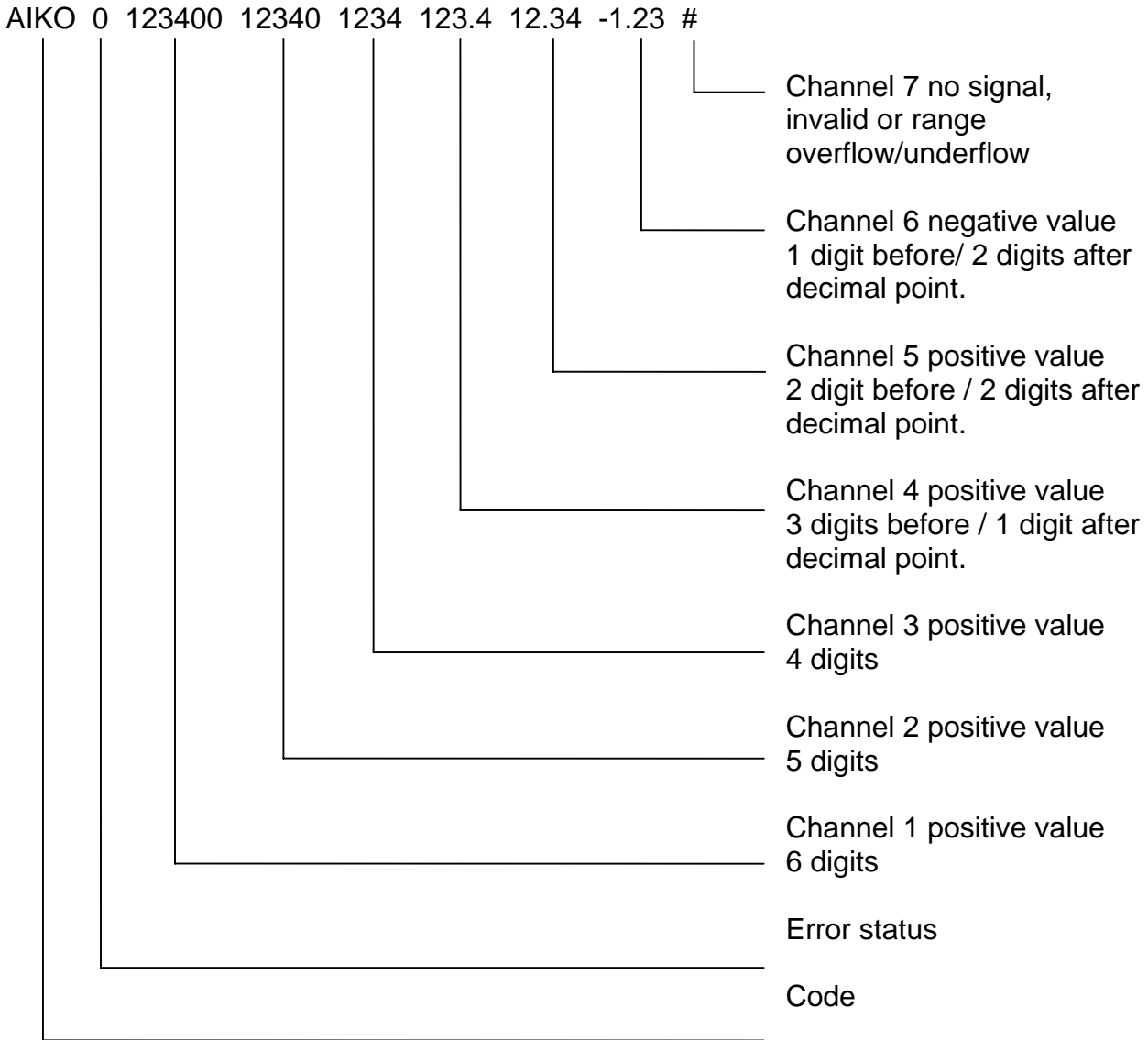

The values will get the same format for the read of single channels.

AKAK – Read command "Calibration gas concentration"

To this read command the analyzers in a system or the single analyzer will send to the TBCC the following data for the called channel (device) and range:

* The calibration gas concentration in ppm.

Read command

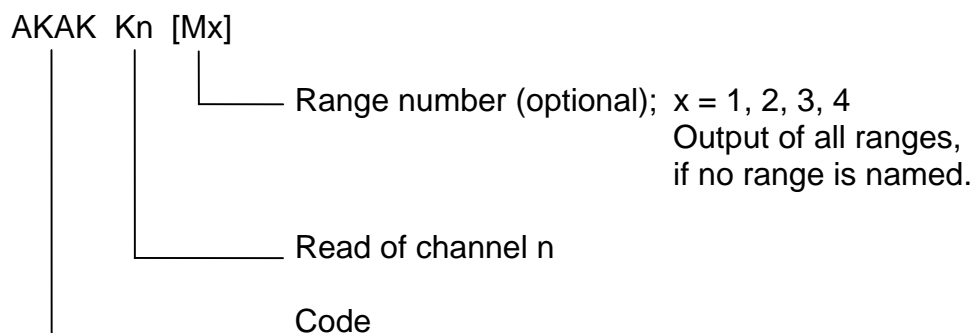

Response

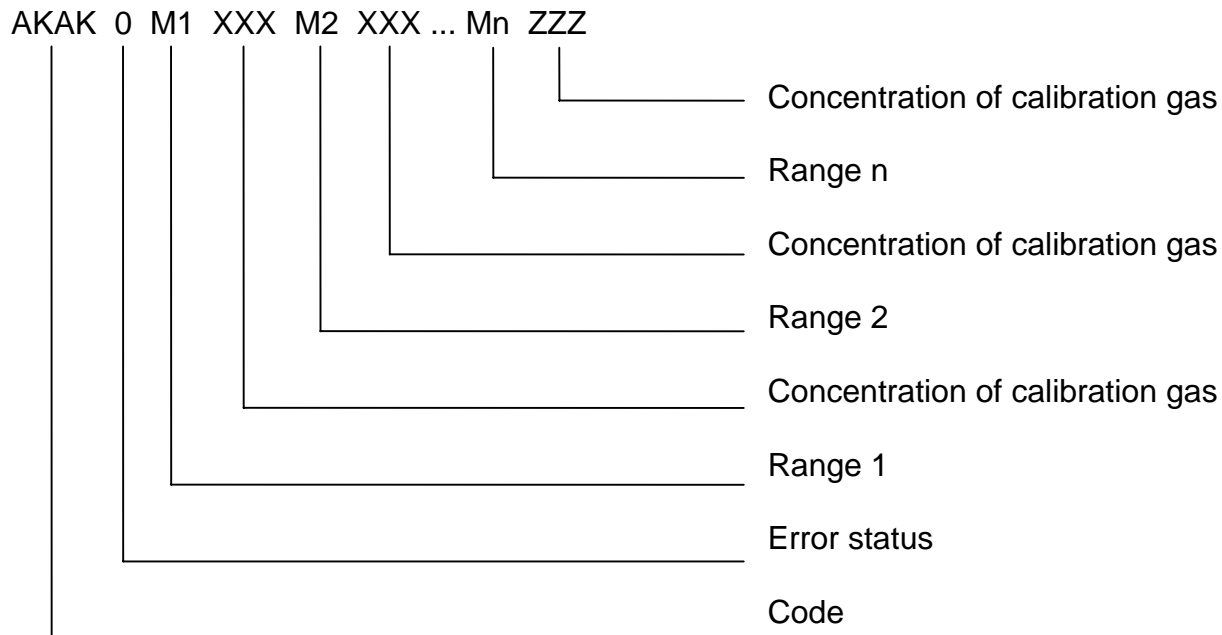

The values will get the same format for the read of single ranges.

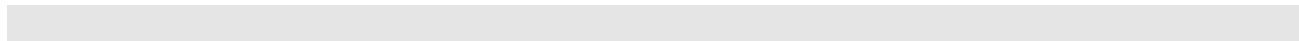

AKAL – Read command "Stored calibration corrections"

To this read command the analyzers in a system or the single analyzer will send to the TBCC the following data for the called channel (device):

- * The corrections in ppm determined and stored during the last calibration. These corrections are also necessary to calculate the analyzer values (deviations from the linearized curve).
- * The sum of deviations (total correction) to the calibration before the last linearization check for the last range calibrated with zero and spangas.

Read command

AKAL K0 [Mx]
AKAL Kn [Mx]

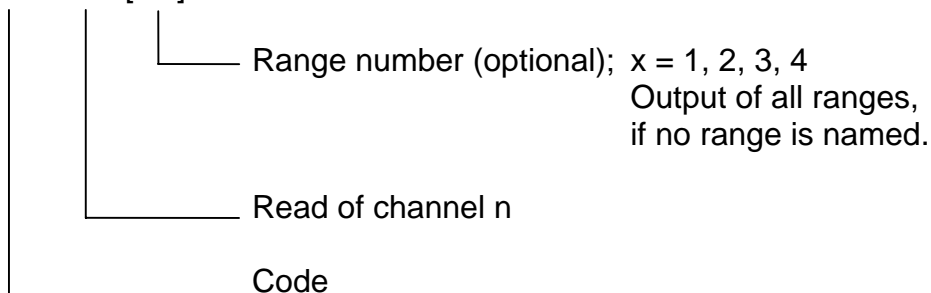

II) V24/RS232/485 Interface - Single Analyzers and Systems

Response

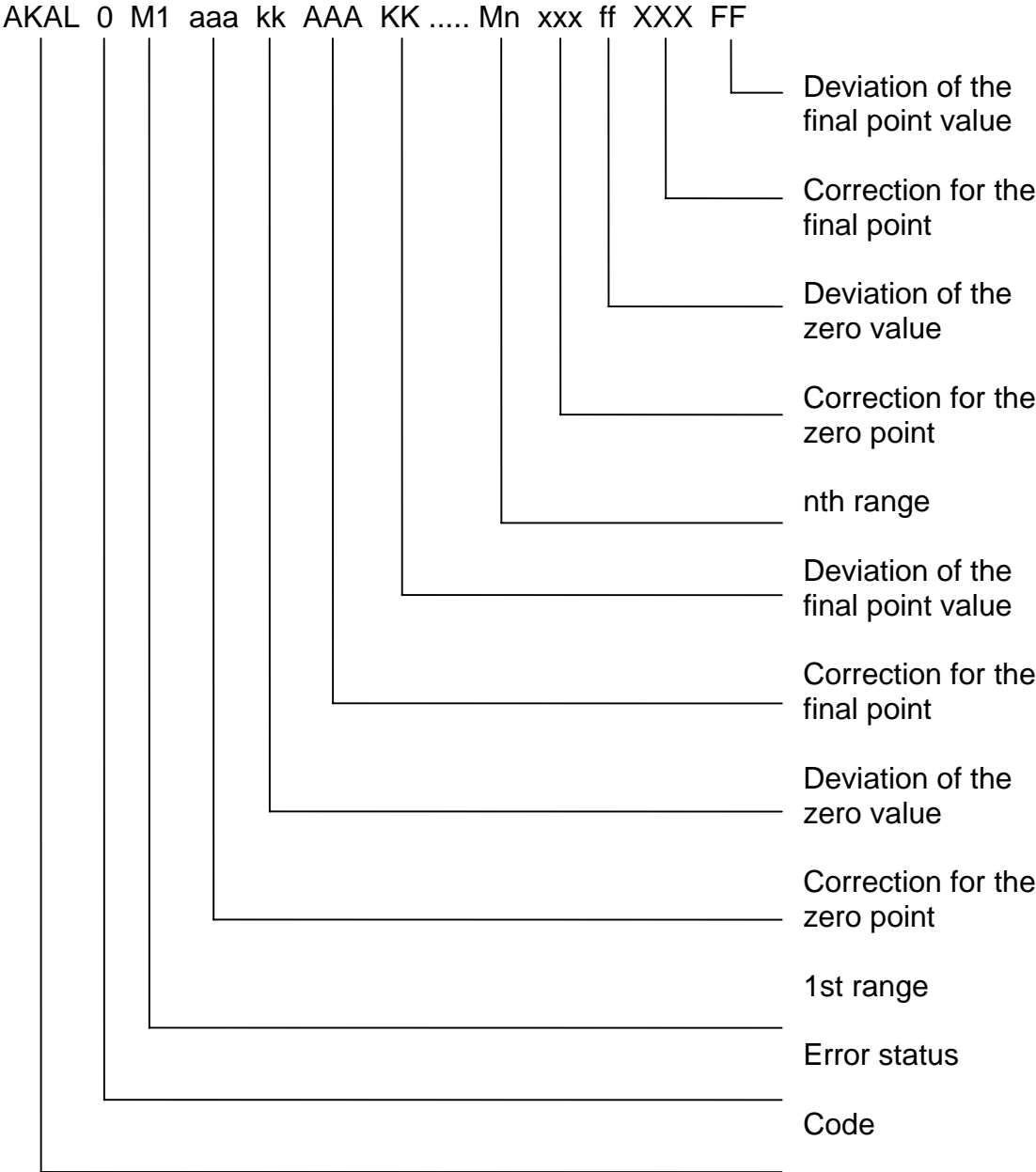

AKEN – Read command "Device tag"

To this read command the FU will send to the TBCC the tag for the called channel (device).

Read command

AKEN K0
AKEN Kn

Read of channel n
Code

Response

AKEN 0 XXX..X

Device tag
Error status
Code

AKFG – Read command "Configuration of the system"

To this read command the system will send to the TBCC the following data:

- * The adjustment about the channels (analyzers or virtual channels) that are expected to send the current signals and the corresponding sequence.
- * The channels that can be called with the total channel command "K0". That means: Which devices can be included with "K0" or "KV Ln" to operation modes like measuring, zerogas and spangas.
- * Which channel will analyze which chemical component.
- * The sequence in which the signals of analyzers or calculated values from virtual channels will be sent to the total channel read command "K0" or "KV Ln". This information will be done by the string "XYZ" standing for each component, e.g. CO, NO, NO_x, BRETT (Lambda according to Brettschneider) etc.

Read command

AKFG K0
AKFG KV Ln

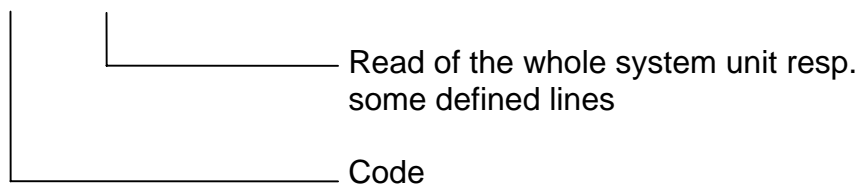

Response

AKFG 0 XYZ Kn XYZ Km XYZ Kx

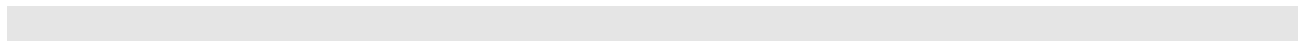
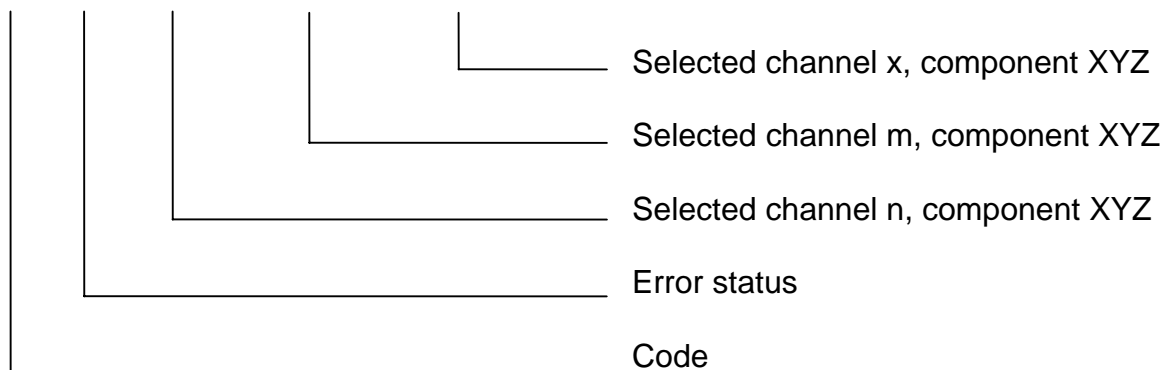

AKON – Read command "Signal" (measured concentration value)

To this read command the analyzers in a system or the single analyzer will send to the TBCC the following data:

- * The corrected signal (concentration value) valid at that moment. Normally the physical unit is ppm. The value will be limited to six relevant digits, because it is useless to send gas concentrations in an accuracy less than pars pro mille.

Example for four relevant digits (default: six digits):

measured conc. [ppm]	sent conc. [ppm]
123456	123500
12356	12360
1234.4	1234
123.45	123.5
12.56	12.56
1.23	1.23

Cf. the "SFRZ" command !

Read command

AKON K0

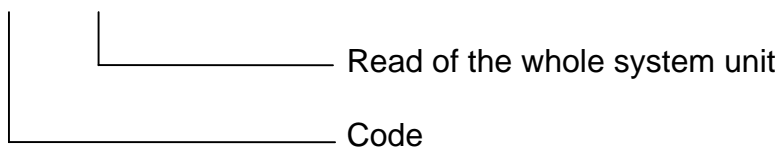

AKON K1 Kn

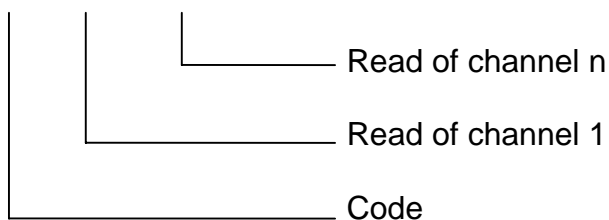

II) V24/RS232/485 Interface - Single Analyzers and Systems

Response

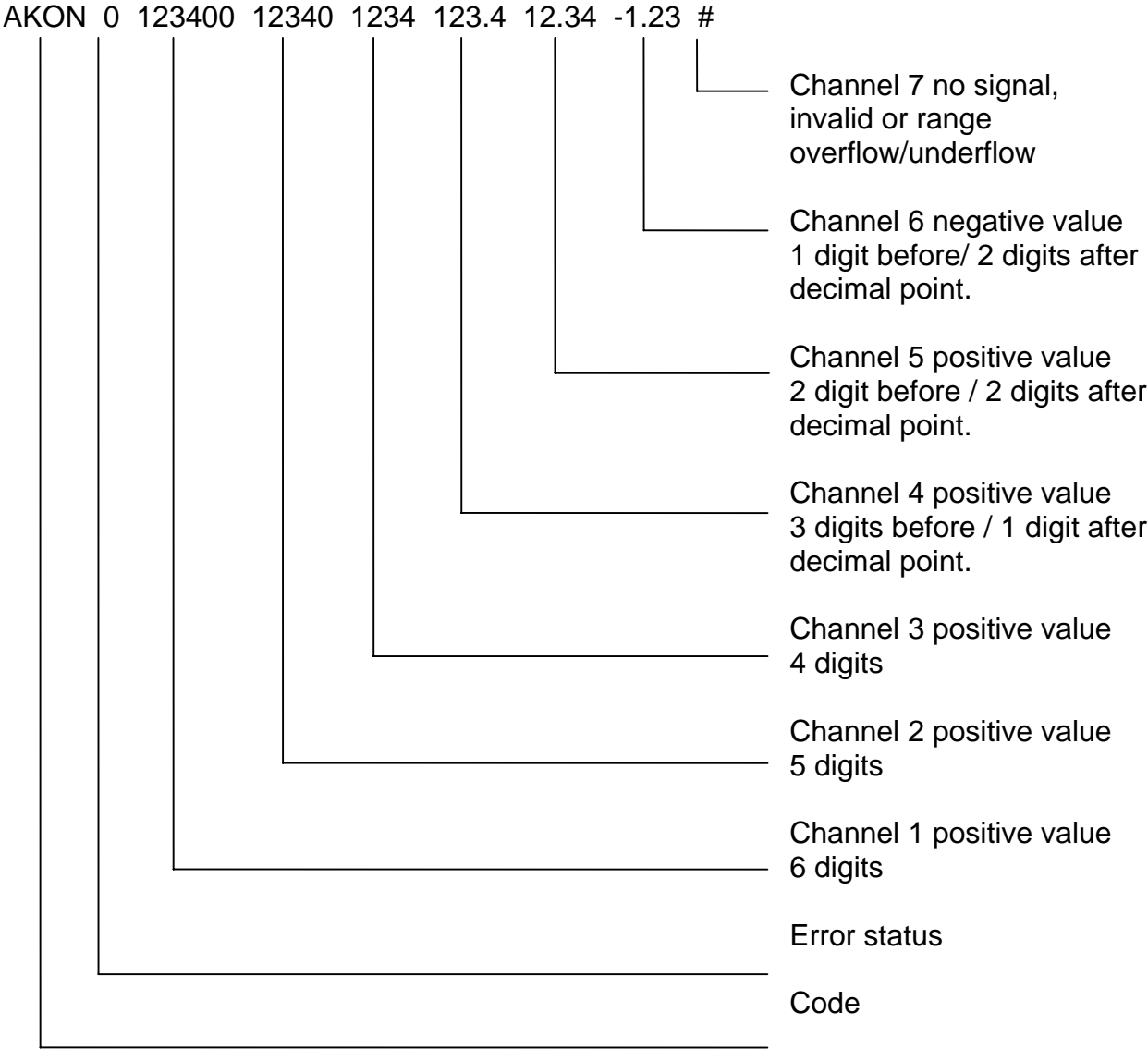

The values will get the same format for the read of single channels.



AKOW – Read command "Correction for zerogas calibration and gradient"

To this read command each analyzer in a system or the single analyzer will send to the TBCC the following data:

* The correction of the last zero calibration and the gradient of the calibration curve.

Read command

AKOW K0 Mx
AKOW Kn Mx

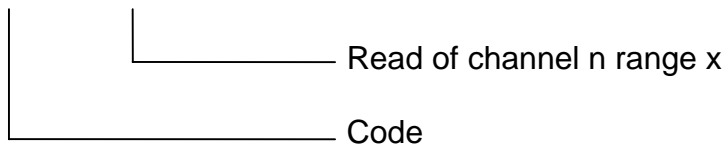

Response

AKOW 0 XXX YYY

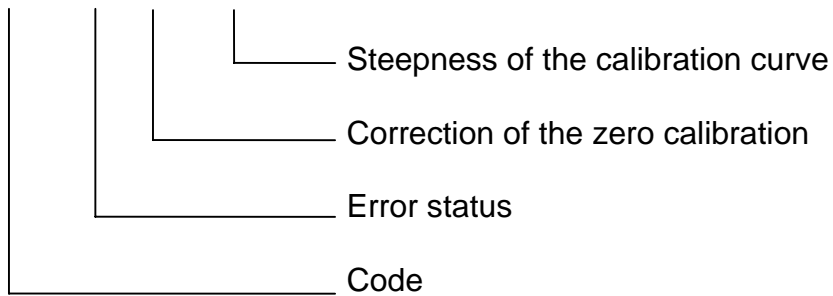

ALCH – Read command "Deviations of the last linearization check"

To this read command the analyzers in a system or the single analyzer will send to the TBCC the following data for the called channel (device) and subchannel (range):

- * The determined and stored deviations of the last linearization check in ppm.
- * The information if these deviations will be in the lawful tolerances. That means: Is the check o.k. or not ?

Read command

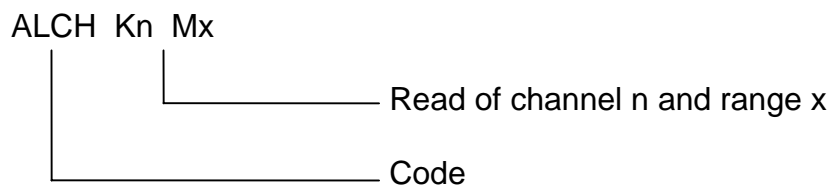

Response

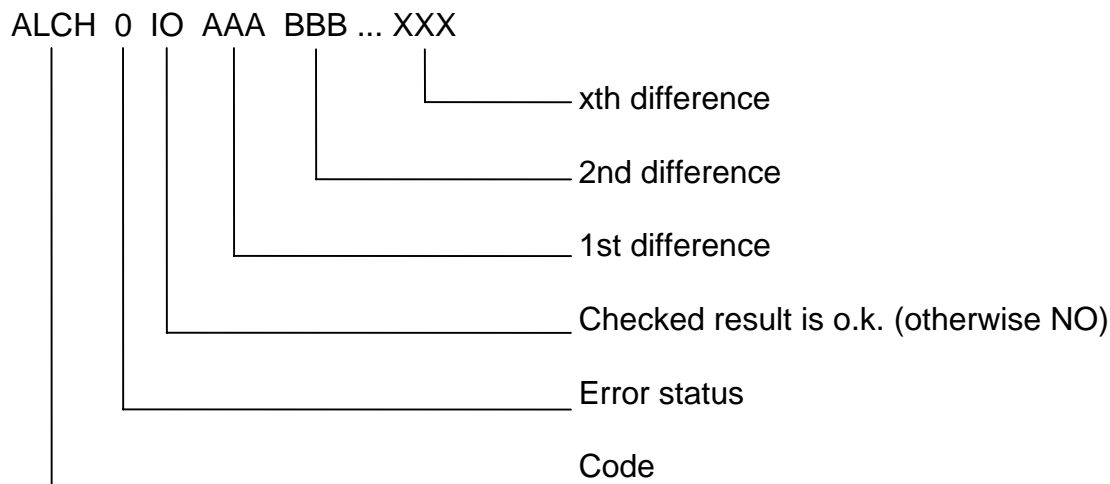

Only for MLT analyzers: ALIK – Read command "Output of the linearization curve"

To this read command the x/y values of the linearization curve will be sent. With this values can be determined the desired segment of the linearization curve and the interval between the function values.

Read command

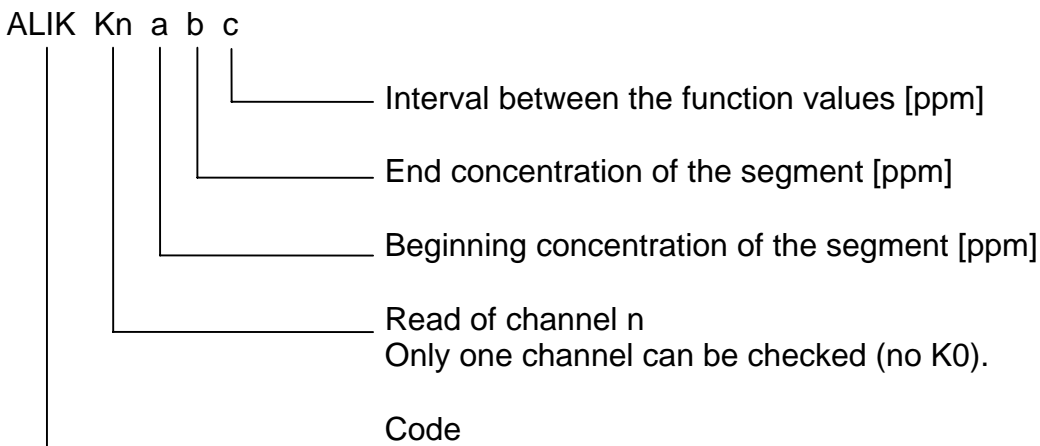

Response

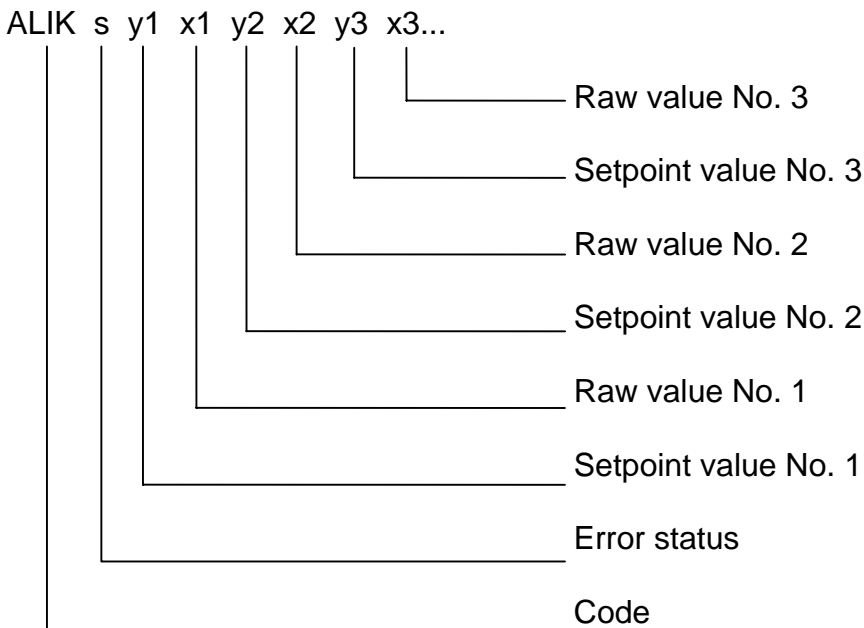

II) V24/RS232/485 Interface - Single Analyzers and Systems

ALIN – Read command "Linearization values" (X/Y = Setpoint / Raw value)

To this read command the analyzers in a system or the single analyzer will send to the TBCC the following data for the called channel (device) and subchannel (range):

* The determined and stored setpoint/raw values of the last linearization.

Read command

ALIN Kn [Mx]

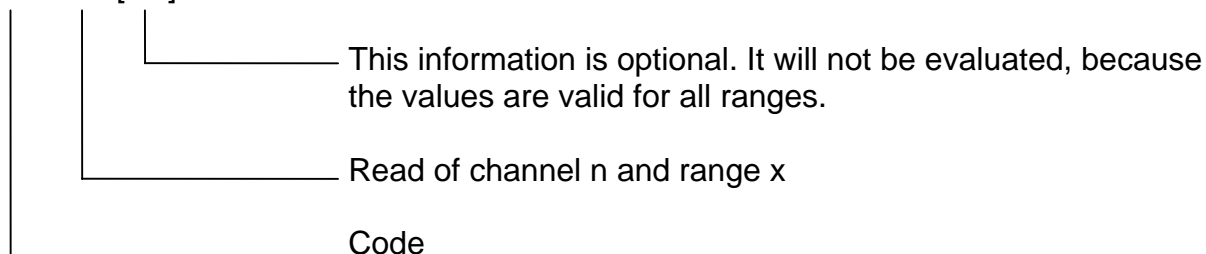

Response

ALIN 0 aaa AAA bbb BBB xxx XXX

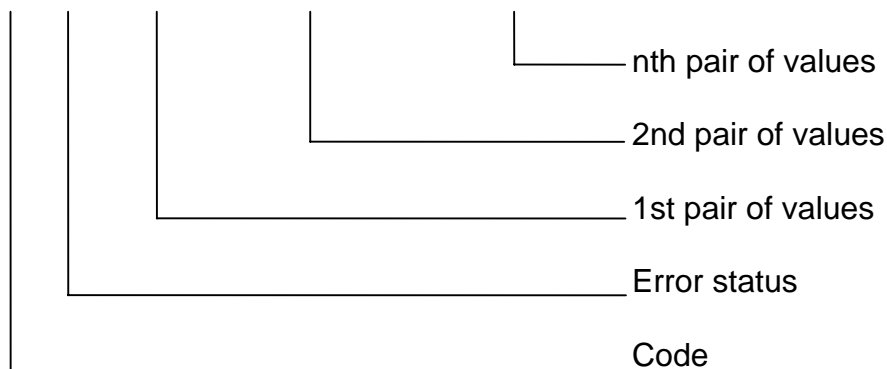

ALKO – Read command "Polynomial coefficients of the linearization curve"

The coefficients of the linearization polynomial calculated by the analyzer linearization will be transferred. These coefficients will be enabled using the polynomial method to linearize.

Read command

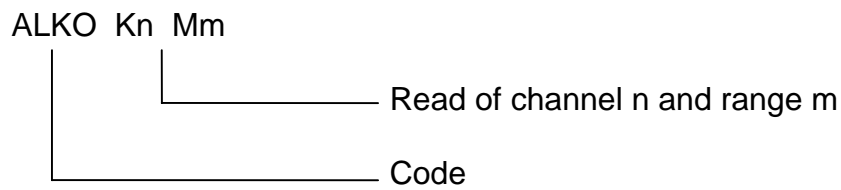

Response

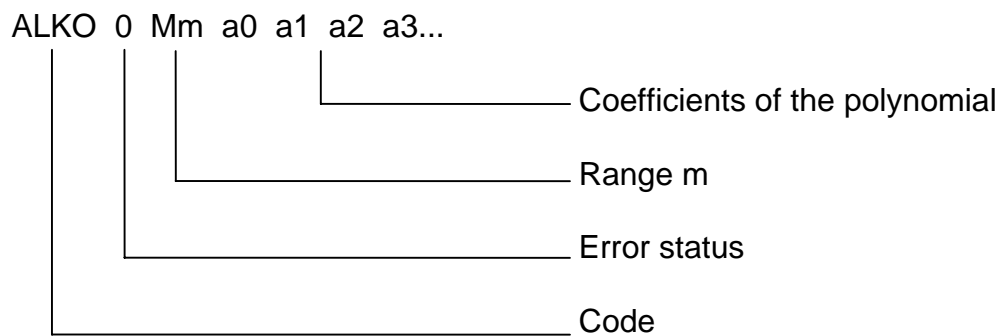

ALST – Read command "Linearization steps"

To this read command the gas distribution will send to the TBCC or to the system the following data:

* The numbers and the division in percent of the distribution steps (maximum two digits after decimal point).

This command will only be accepted by the gas distribution, if the commands "SLIN" or "SLCH" have been received before.

Read command

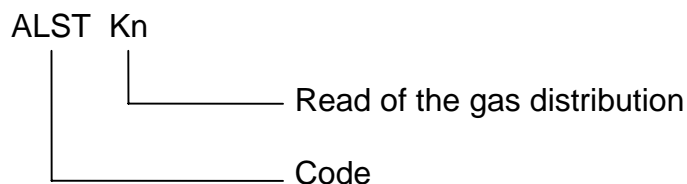

Response

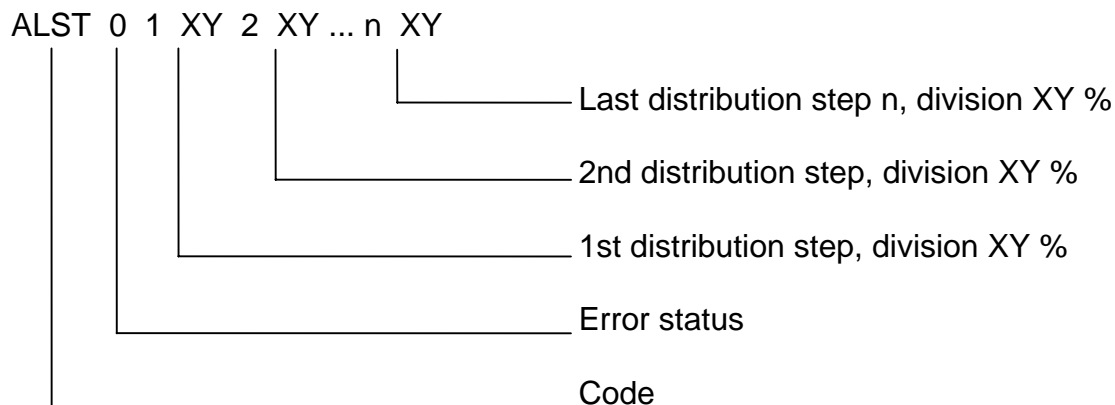

AM90 – Read command "Actual response time (t_{90})"

To this read command the analyzer will send the t_{90} time in seconds that is enabled to calculate the concentration for the called channel at the moment.

Cf. "AT90", "ET90", "ST90" and "EM90"

Read command

AM90 Kn
├── Read of channel n
└── Code

Response

AM90 0 a
├── t_{90} time (response time) [s]
├── Error status
└── Code

AMBA – Read command "Begin of range"

To this read command the analyzers in a system or the single analyzer will send to the TBCC the following data for the called channel (device):

* The begin of range values in ppm.

Read command

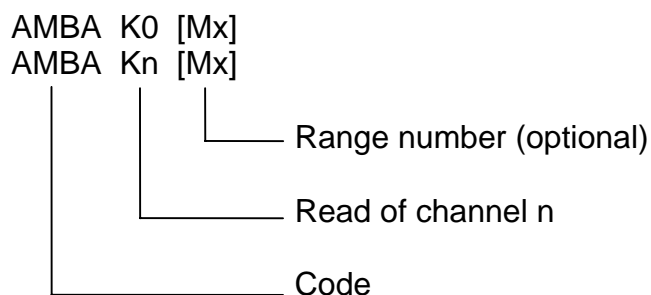

Response

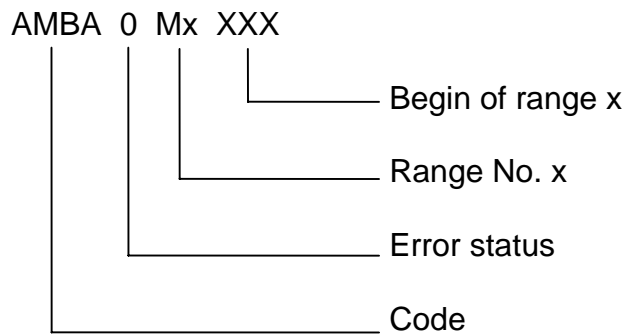

The values will get the same format for the read of single channels.

AMBE – Read command "End of range"

To this read command the analyzers in a system or the single analyzer will send to the TBCC the following data for the called channel (device):

* The end of range values in ppm.

Read command

AMBE K0 [Mx]

AMBE Kn [Mx]

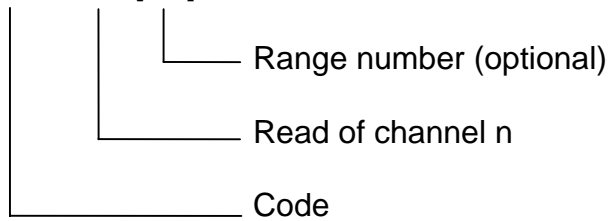

Response

AMBE 0 Mx XXX

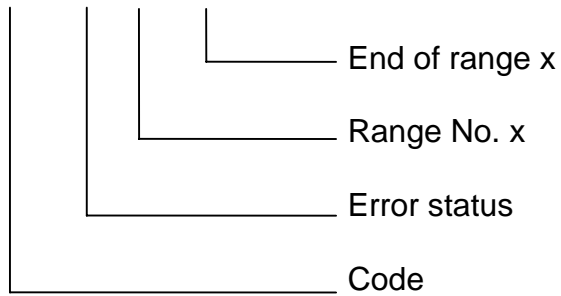

The values will get the same format for the read of single channels.

AMBU – Read command "Switching values for autoranging"

To this read command the analyzers in a system or the single analyzer will send to the TBCC the following data for the called channel (device):

* The adjusted switching values in ppm for a changing of ranges with autoranging.

Read command

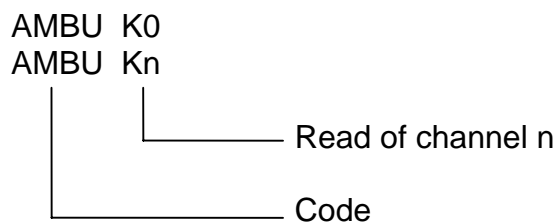

Response

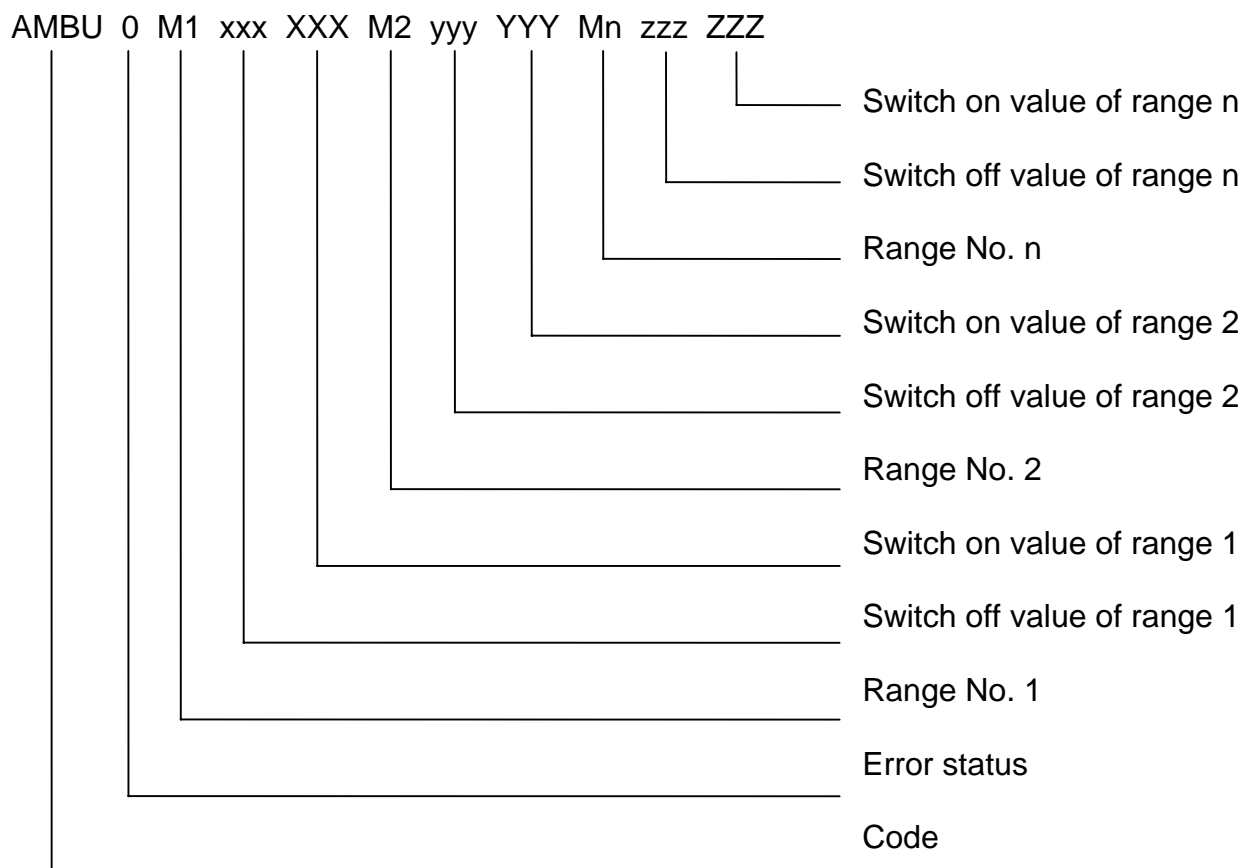

The values will get the same format for the read of single channels.



AMDR – Read command "Manual adjusted pressure"

To this read command the gas analyzer will send the value adjusted for the parameter. This value will be useful, if no pressure measurement will be installed in the analyzer.

Read command

AMDR Kn
├── Read of channel n
└── Code

Response

AMDR 0 a
├── Pressure [Pa]
├── Error status
└── Code

The values will get the same format for the read of single channels.

II) V24/RS232/485 Interface - Single Analyzers and Systems

AQEF – Read command "Cross interference"

To this read command the CO analyzer or the system will send to the TBCC:

- * The concentration value in ppm determined and stored in the analyzer. This value will be stored in the device until a new cross interference will be determined by the "SQEF" command. The TBCC will control, if limits will be exceeded. The TBCC will also start actions if necessary.

Read command

AQEF Kn
├── Read of channel n
└── Code

Response

AQEF 0 XXX
├── Interference [ppm]
├── Error status
└── Code

ASOL – Read command "Setpoint value with limits"

To this read command the FU will send to the TBCC the following data for the called channel (FU) and subchannel (e.g. heating):

* The adjusted setpoints with deviation limits for error reports.

For the actual used devices subchannel "m" will be:

m = 0	Concentration
m = 1	Temperature
m = 2	Pressure
m = 3	Flow
m = 4	Pocket calculator No. 1
m = 5	Pocket calculator No. 2
m = 6	Pocket calculator No. 3
m = 7	Pocket calculator No. 4

These assignments may be changed for devices used in the future !

Read command

ASOL K0 m

ASOL Kn m

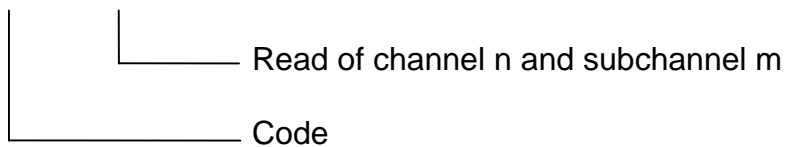

Response

ASOL 0 WWW xxx XXX

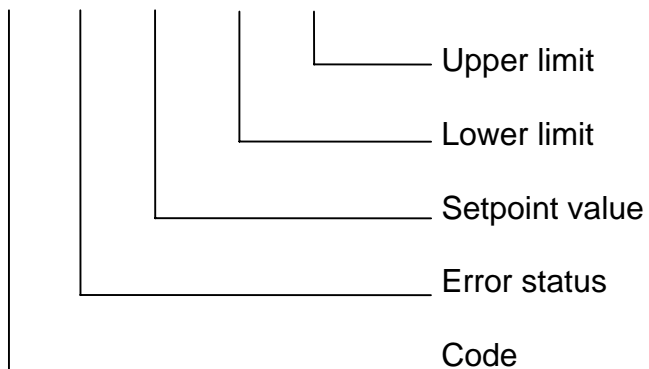

ASTA – Read command "General status of the system"

To this read command the FU will send to the TBCC:

- * All channels of the FU with any error in their status at that moment. A detailed description of the errors will not be sent to this read command. It is only possible to read channel No. 0.

Read command

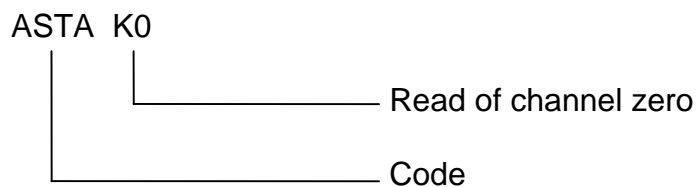

Response

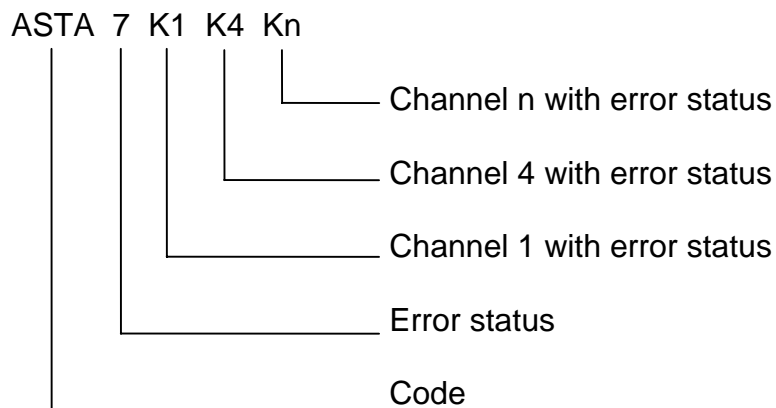

ASTF – Read command "Error status"

To this read command the FU will send to the TBCC:

- * All error existing at that moment in the called channel (FU). The description of the error characterization is specific for each device. It will be symbolized with a number. A reading to "K0" will get the errors of devices that are not assigned to single channels (e.g. samplegas cooler).

Read command

ASTF Kn

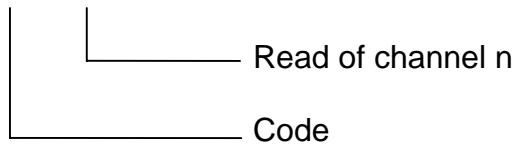

Response

ASTF 7 XXX YYY ... NNN

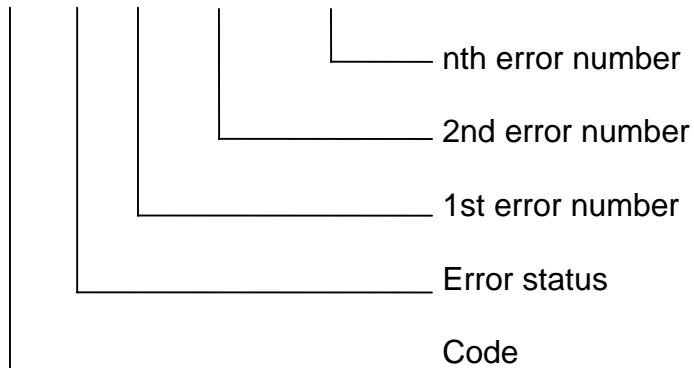

II) V24/RS232/485 Interface - Single Analyzers and Systems

Typical meanings of errors for certain devices:

NDIR/NDUV Analyzers

- No. 1 = Flow error
- No. 2 = Chopper failure
- No. 3 = Thermostat failure
- No. 4 = RAM error
- No. 5 = Calibration error zerogas
- No. 6 = Calibration error spangas
- No. 7 = Range overflow
- No. 8 = External error (digital input)
- No. 9 = Error of pressure measurement
- No.10 = Error of temperature measurement

TFID Analyzers

- No. 1 = Flow error
- No. 2 = Flame out
- No. 3 = Thermostat failure
- No. 4 = RAM error
- No. 5 = Calibration error zerogas
- No. 6 = Calibration error spangas
- No. 7 = Range overflow
- No. 8 = Fuel gas error
- No. 9 = Fuel air error
- No.10 = H₂ generator failure (optional H₂ generators, if available)
- No.11 = Temperature of the heated wires
- No.12 = Temperature of the heated filters
- No.13 = Response of ethane too high (optional for methane free measurement)

ASTZ – Read command "Status"

To this read command the FU will send to the TBCC the following data for the called channel (FU):

- * The device status at that moment
- * Running procedures.

The status will be described by the code used for the activation of the function. The operation modes "REMOTE" or "MANUAL" will also be sent. These modes will always be the first codes in the data string. To the read of channel 0 the statuses of all channels (FU) defined with "EKFG" will be sent. If a defined FU will be defect or not available and it cannot send its status, the statuses of these channels (FU) will be replaced by "#", analogous to the values like described for "AKON".

Read command

ASTZ K0

ASTZ Kn

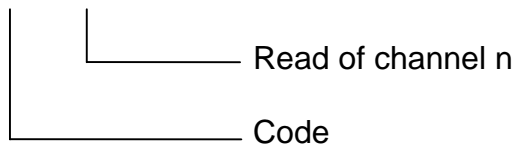

II) V24/RS232/485 Interface - Single Analyzers and Systems

Response

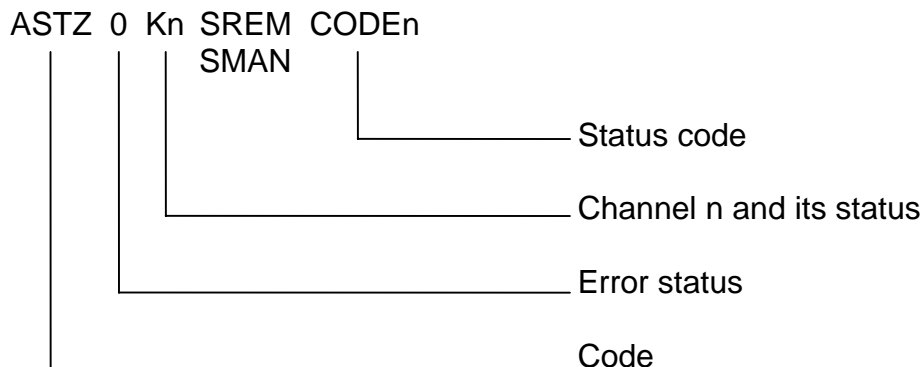
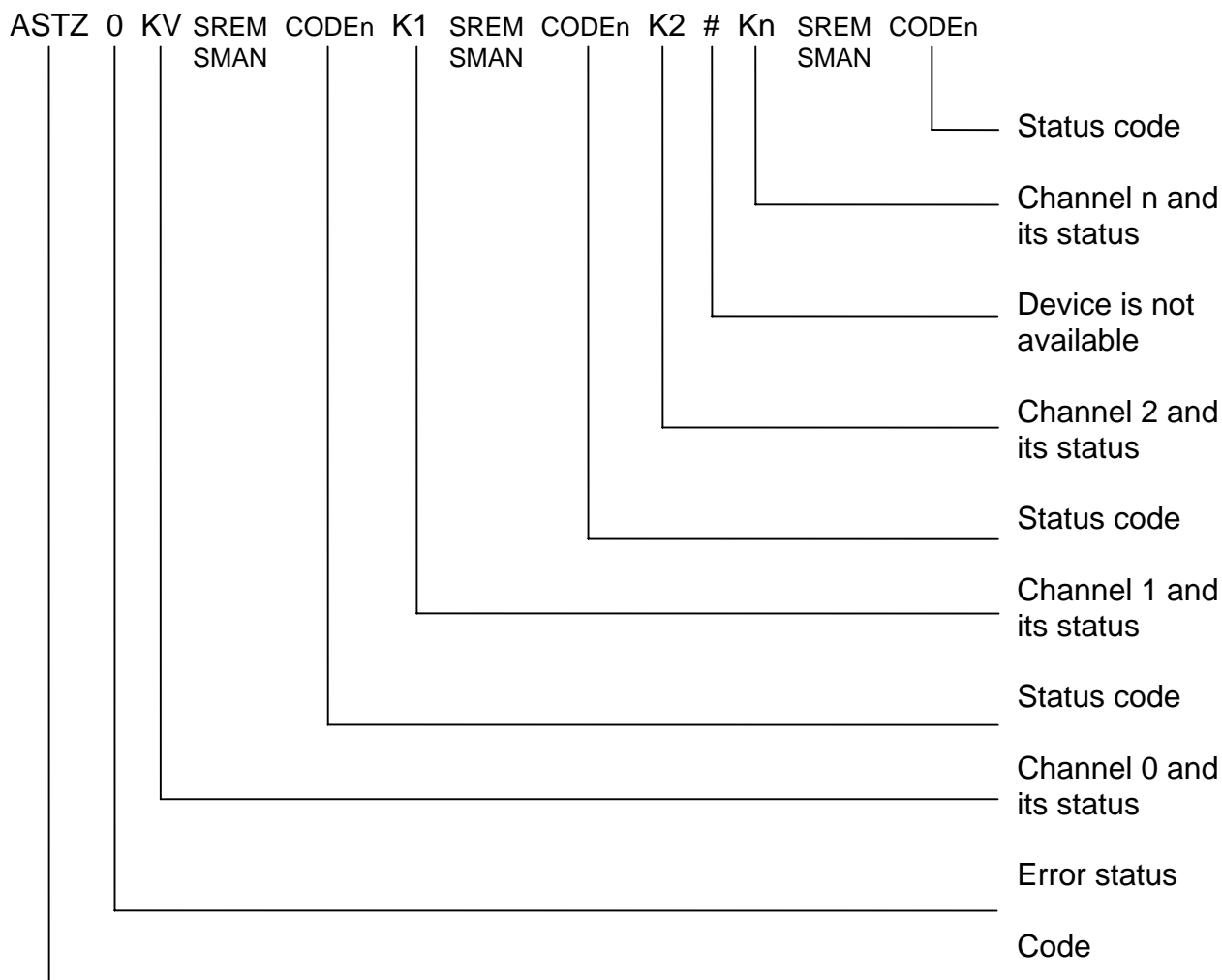

ASYZ – Read command "System time"

To this read command the FU will send to the TBCC the following data for the called channel (device):

- * The current system time (calendar time).

Read command

ASYZ Kn

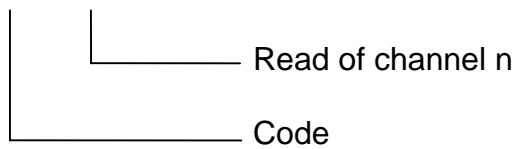

Response

ASYZ 0 JJMMTT hhmmss

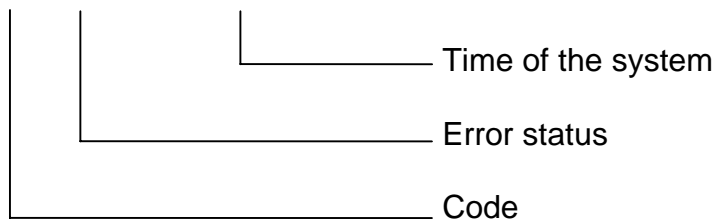

AT90 – Read command "T₉₀ time" (response time)

To this read command the analyzers in a system or the single analyzer will send to the TBCC the following data for the called channel (device):

- * The t₉₀ time steps.

Read command

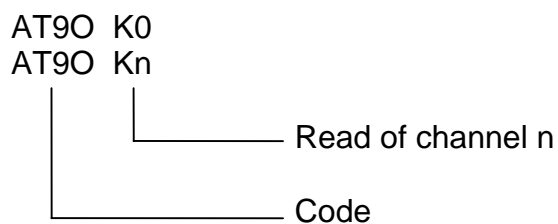

Response

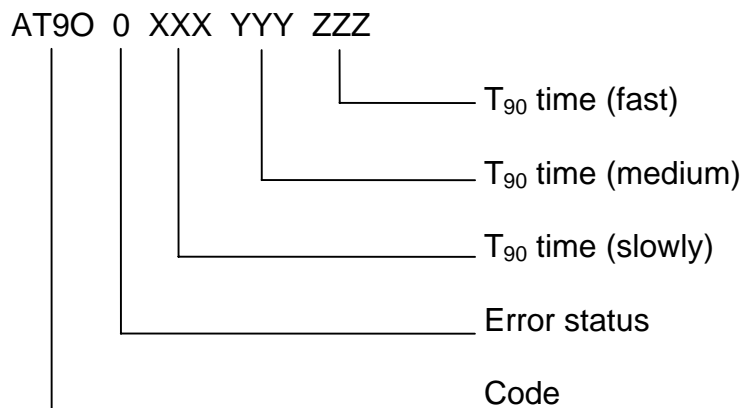

ATEM Read command "Temperature"

To this read command the analyzers in a system or the single analyzer will send to the TBCC the following data for the called channel (device) and subchannel (temperature measurement):

* The signal in Kelvin.

Read command

ATEM K0 (m)

ATEM Kn (m)

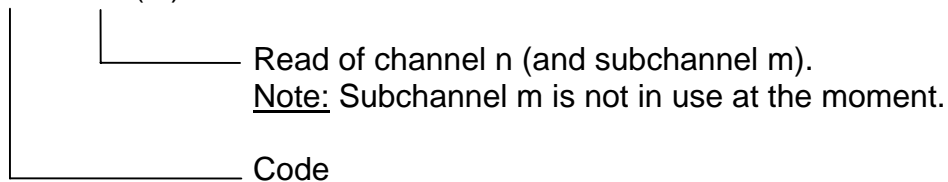

Response

ATEM 0 XXX

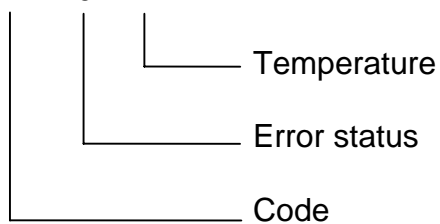

ATOL – Read command "Stability tolerances"

To this read command the analyzers in a system, the single analyzer or the front-end computer will send to the TBCC the following data:

- * The necessary tolerances for functions running stability controlled.

Read command

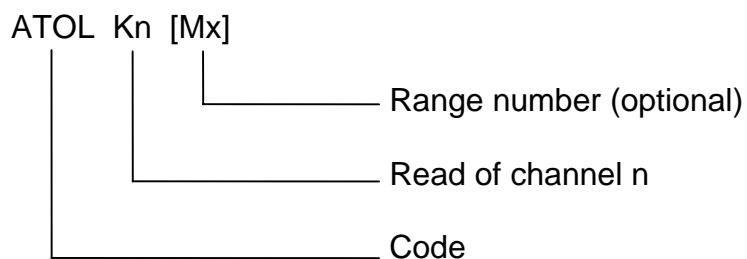

Response

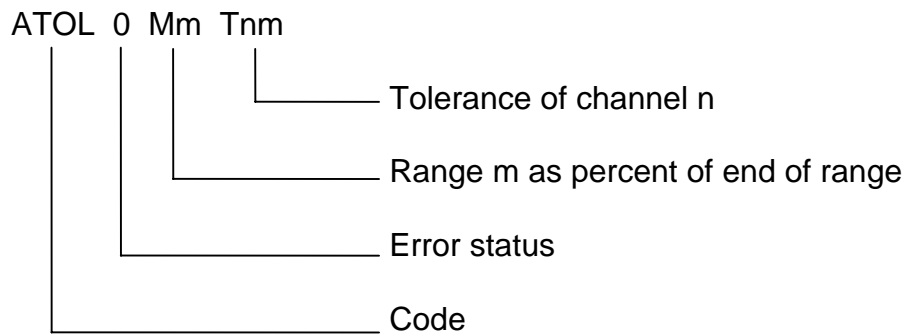

AUKA – Read command "Uncorrected analog value"

To this read command the called analyzer in a system or the single analyzer will send to the TBCC the following data:

- * The uncorrected analog output value in Volt and the corresponding range.

Read command

AUKA K0
AUKA Kn

Read of channel n
Code

Response

AUKA 0 Mn XXX

Uncorrected analog value
Range n
Error status
Code

AVEZ – Read command "Delay and synchronization time"

To this read command the analyzers in a system or the single analyzer will send to the TBCC the following data for the called channel (device):

- * The delay time used for the record of valid signals or used to start the integrators by "SINT".
- * The synchronization time used for the output of values from an internal buffer that were read by "AKON", "AIKO" and "AIKG". This synchronization time is also the delay time for the output signal of those values.

This procedure will be started with the control command "SRON" and will be finished with the control command "SROF".

Read command

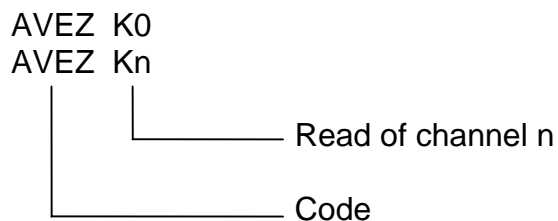

Response

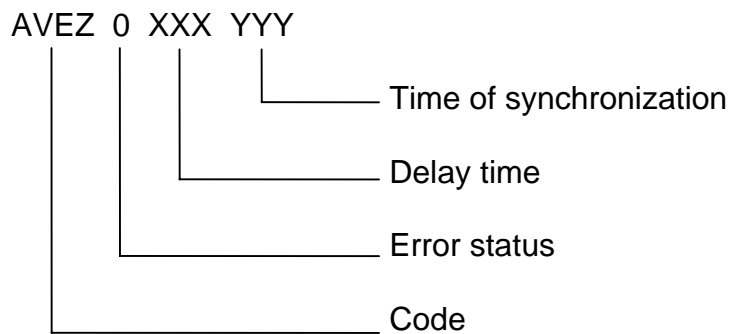

AZEI – Read command "Times"

To this read command the FU will send to the TBCC the following data for the called channel (FU):

- * The times used to start a function or procedure, e.g. times for the automatic start of a calibration.

Read command

AZEI Kn CODE

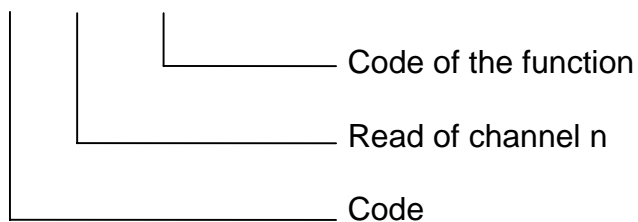

The following codes will be supported:

SNAB, SPAB, SATK, SNGA, SEGA, SQEF, SSPL, SALI, SMGA

Response

AZEI 0 JJMMTT hhmmss T-0

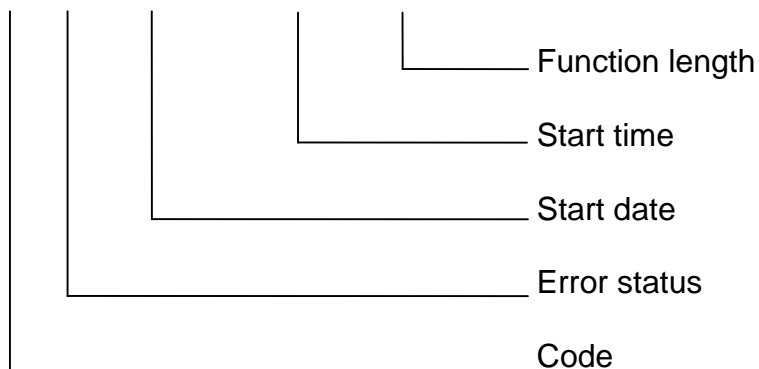

5. Description of all Write Commands

EFDA – Write command "Function length"

With this write command the FU will get the function length of the function "SXXX" in seconds for the called channel (device), e.g. "Time Out" for purging or for switching on the calibration gases. If the function "SXXX" will be a procedure with several internal steps, the times will be valid for each step and not for the whole procedure. If the function will be for instance "Automatic calibration", the times will be valid for each spangas resp. each range and not for the whole procedure. During this time of flow the analyzer will test, if the setpoint value will be reached and stable. If this test will not succeed during the function time, it will produce a function error. The same effect will exist for other procedures like linearization, converter test etc. If the function length will be set to zero, the function will run without any time limit.

Functions like "SATK", "SLIN", "SLCH", "SALI", "SQEF", "SNGA" or "SEGA" will run time controlled according to the times T1 to T4 or stability controlled.

Time control: If only T1 is set or if T2 = 0, time control will run with step time T1 (total function time).

Stability control: Times T1 to T4 have to be set.

Write command

EFDA Kn SXXX T1 (T2 T3 T4)

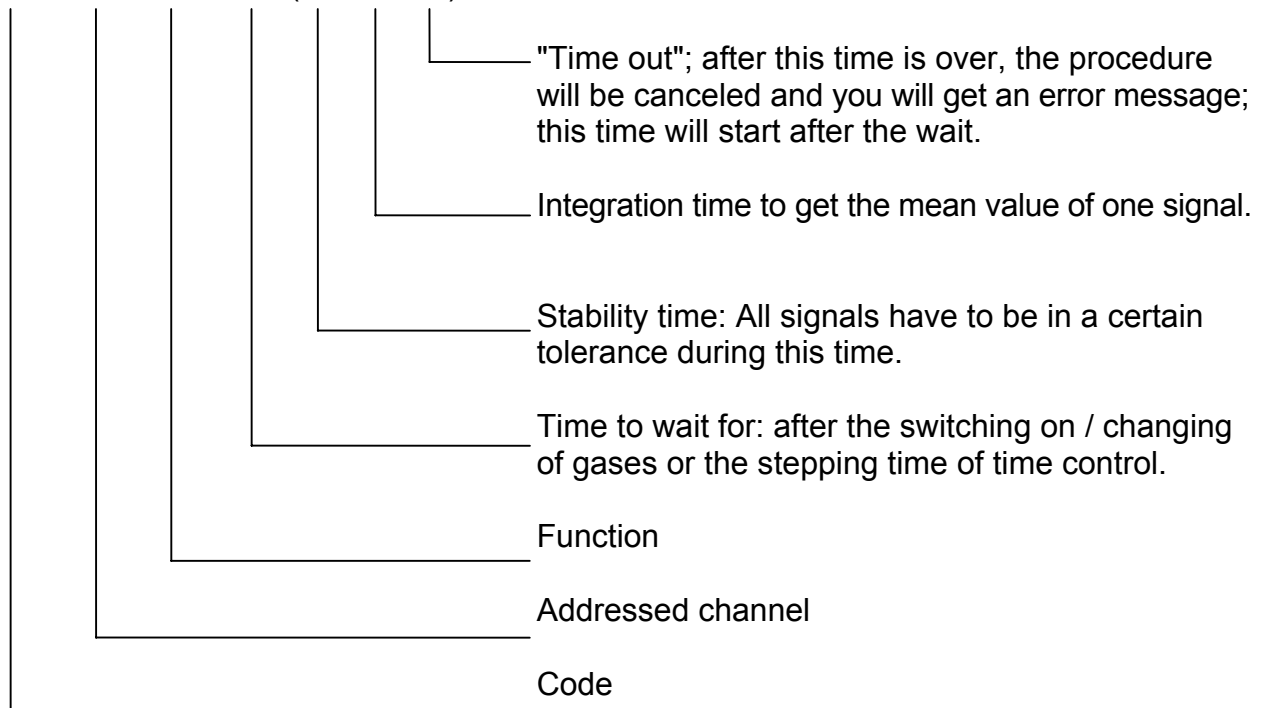

Response

EFDA 0

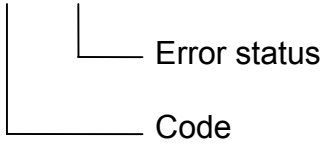

EGRW – Write command "Limit"

With this write command the analyzers in a system or the single analyzer will get the required limits for the called channel (device), e.g. maximum deviation for calibration. If these limits will be exceeded during the operation, it will cause a changing of the error status byte. – The unit of limits is percent. The deviation value is referred to the setpoint. For zero calibration the deviation value will be referred to the smallest spangas value.

Write command

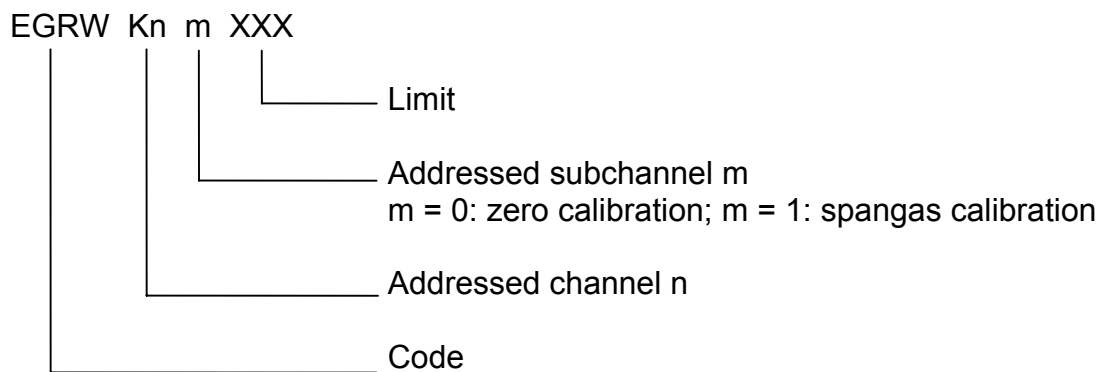

Response

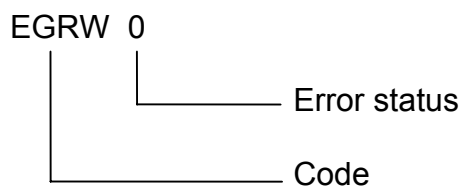

EKAK – Write command "Calibration gas concentration"

With this write command the analyzers in a system or the single analyzer will get the spangas values for each range.

Write command

EKAK K0 M1 YYYY ... Mx ZZZZ

EKAK Kn M1 YYYY ... Mx ZZZZ

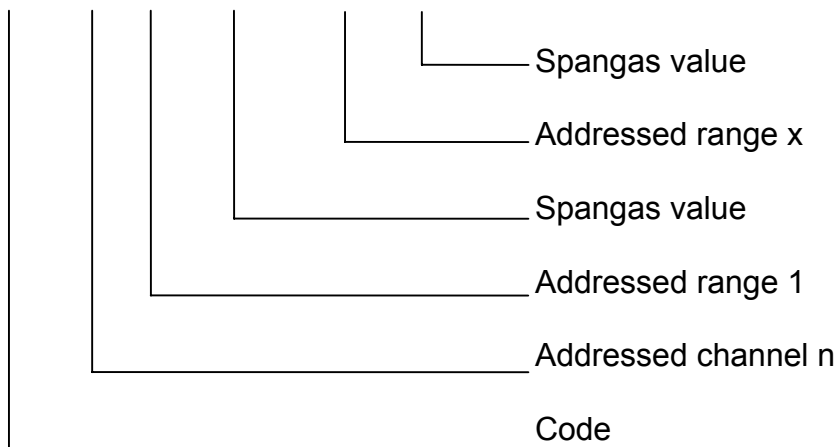

Response

EKAK 0

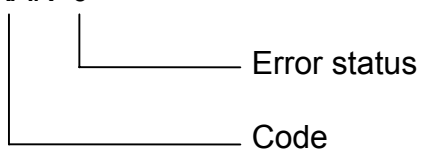

EKEN – Write command "Device tag"

With this write command the FU will get a tag to store in the FU memory. Then it will have to be unchangeable. That means, if this part of memory will be written, the device processor will have to save it against an overwriting automatically. The setup of a new tag will only be possible by changing the processor. The memory size for the tag is 30 ASCII characters.

Write command

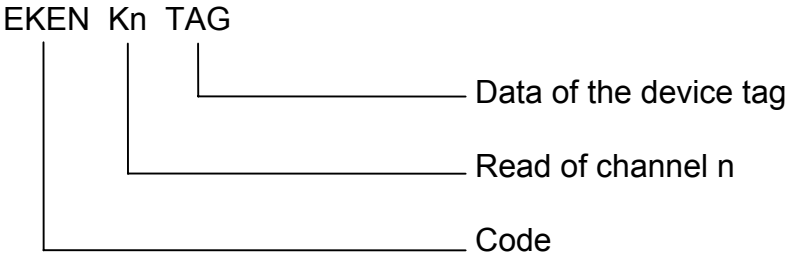

Response

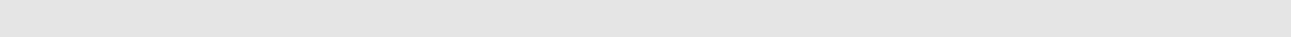
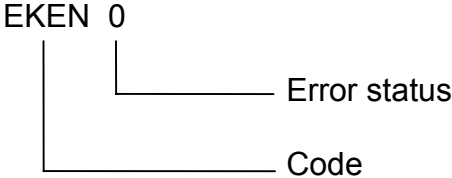

EKFG – Write command "Configuration of the system"

With this write command the FU will get the channels (analyzers) sending the current signals and their sequence. Furthermore the FU will get the channels that should be called with the total channel command "K0" or "KV Ln", i.e. the channels that shall be included to operation modes like measurement, zerogas and spangas. With the string XYZ the FU will be told which chemical component or virtual device (e.g. Lambda) shall be combined with which channel. The string XYZ will be for instance C0, N0, No_x or BRETT (Lambda according to Brettschneider) etc. The other physical or virtual channels can only be called directly with their channel number.

If no component and no channel number will be specified, the FU will get its default configuration of the system. That means, that all physical and virtual available components will be included to the read and control commands with the total channel command "K0" or "KV Ln". Besides, the TBCC can get the real physical composition of the FU with the read command "AKFG".

Write command

EKFG K0 XYZ Kn XYZ Km XYZ Kx

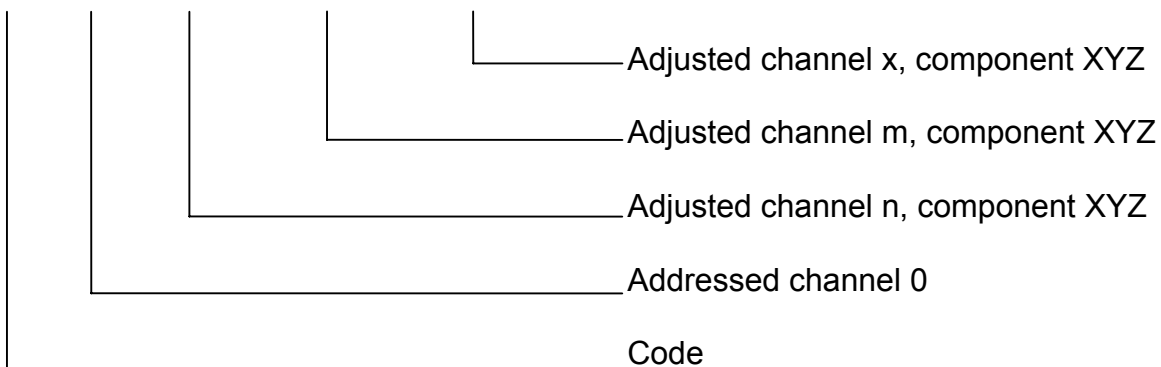

EKFG KV Ln Kn ... Kx

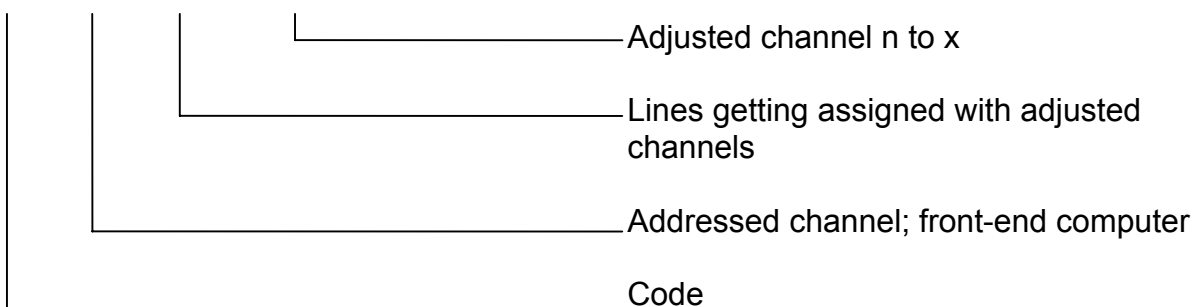

Response

EKFG 0



ELIN – Write command "Linearization values (X/Y)"

With this write command the analyzers in a system or the single analyzer will get the linearization values for the calculation of gas concentration for the called channel (device) and subchannel (range). A new linearization curve will be calculated with these x/y-pairs.

Write command

ELIN Kn Mx aaa AAA bbb BBB ... xxx XXX

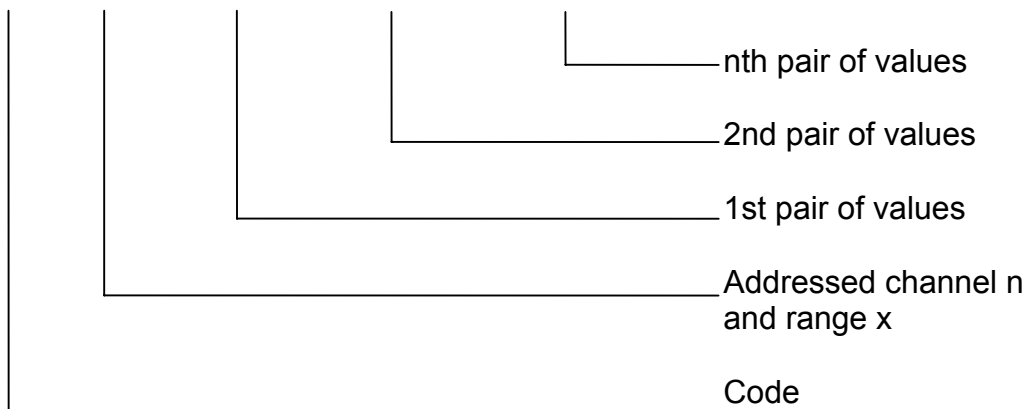

Response

ELIN 0

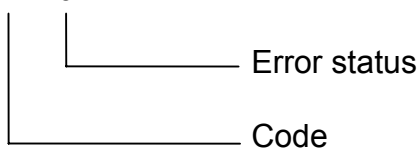

ELKO – Write command "Polynomial coefficients of the linearization curve"

The coefficients of a linearization polynomial will be transferred to the analyzer. These values will then be enabled to calculate the gas concentration using the polynomial method for linearization.

Write command

ELKO Kn a0 a1 a2 a3...

Polynomial coefficients
Read of channel n
Code

Response

ELKO 0

Error status
Code

ELST – Write command "Linearization steps"

With this write command the device will get the numbers of the distribution steps and each division in percent of the gas distribution used for linearization. But this command will only be accepted, if the commands "SLIN" or "SLCH" were received before.

Write command

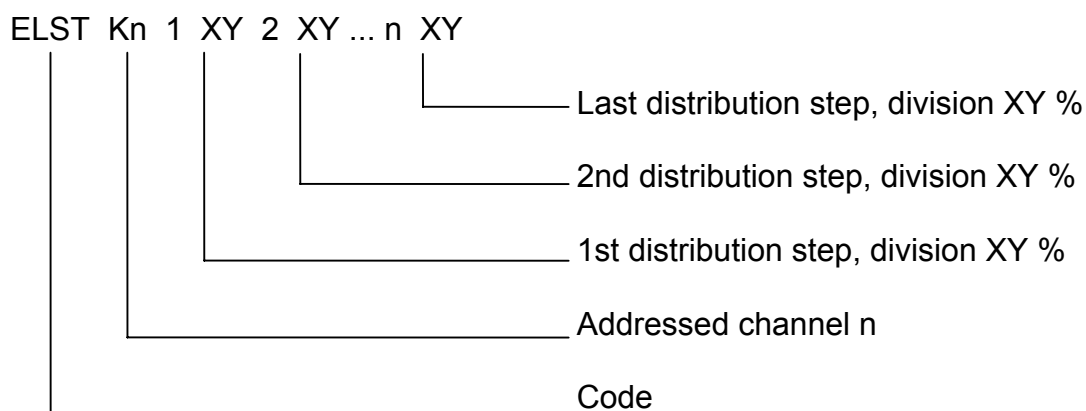

Response

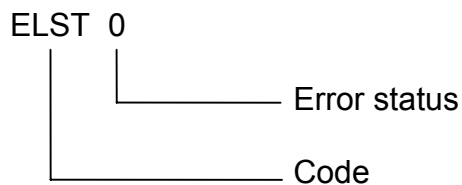

EMBA – Write command "Begin of range"

With this write command the analyzers in a system or the single analyzer will get each begin of range of the total range in ppm. The analog output signal will be referred to these values for instance.

Write command

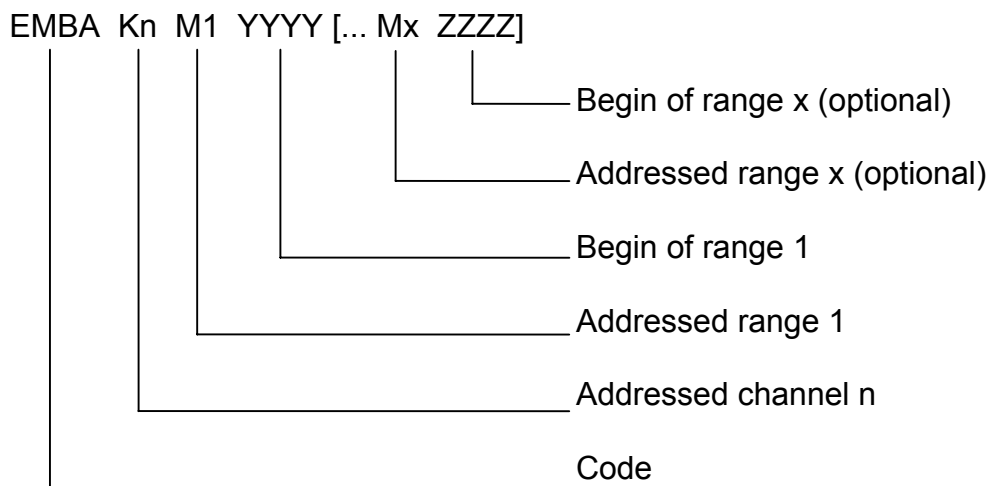

Response

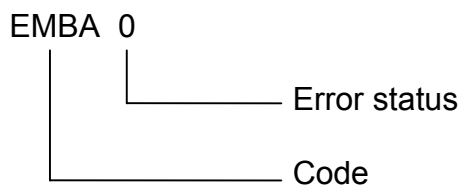

EMBE – Write command "End of range"

With this write command the analyzers in a system or the single analyzer will get each end of range of the total range in ppm. The analog output signal will be referred to these values for instance.

Write command

EMBE Kn M1 YYYY [... Mx ZZZZ]

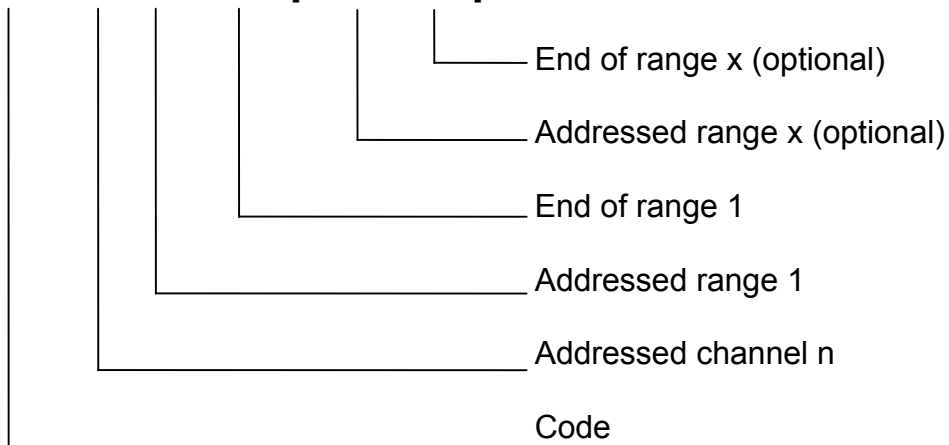

Response

EMBE 0

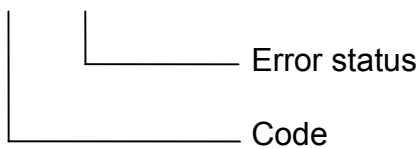

EMBU – Write command "Switch levels for autoranging"

With this write command the analyzers in a system or the single analyzer will get for the called channel (device):

* The required values in ppm to switch from one range to another with autoranging.

Write command

EMBU Kn Mn XXX YYY [Mm XXX YYY ...] (optional)

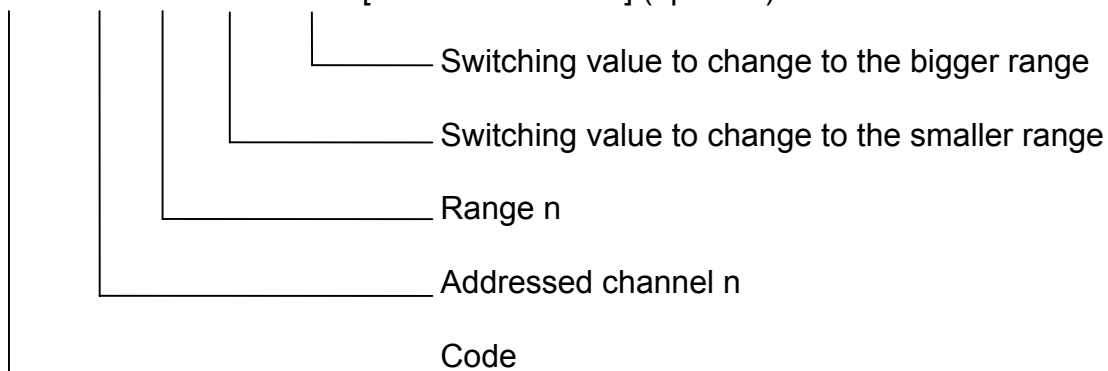

Response

EMBU 0

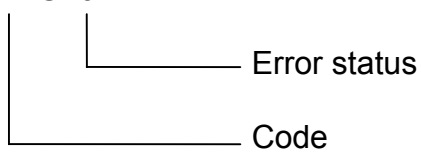

EMDR – Write command "Manual adjusted pressure"

With this write command the analyzer will get a pressure value for the called channel. This value will be used as pressure correction, if no pressure measurement is installed in the device.

Cf. "AMDR", "ADRU" !

Write command

EMDR Kn a

Pressure in Pa
Read of channel n
Code

Response

EMDR 0

Error status
Code

ESOL – Write command "Setpoint value with limits"

With this write command the FU will get the required setpoint values with acceptable deviations for the called channel (device) and subchannel (e.g. heating). If these limits will be exceeded during the operation, it will cause a changing of the error status byte.

For the actual used devices subchannel "m" will be:

- m = 0 Concentration
- m = 1 Temperature
- m = 2 Pressure
- m = 3 Flow
- m = 4 Pocket calculator No. 1
- m = 5 Pocket calculator No. 2
- m = 6 Pocket calculator No. 3
- m = 7 Pocket calculator No. 4

These assignments may be changed for devices used in the future !

Write command

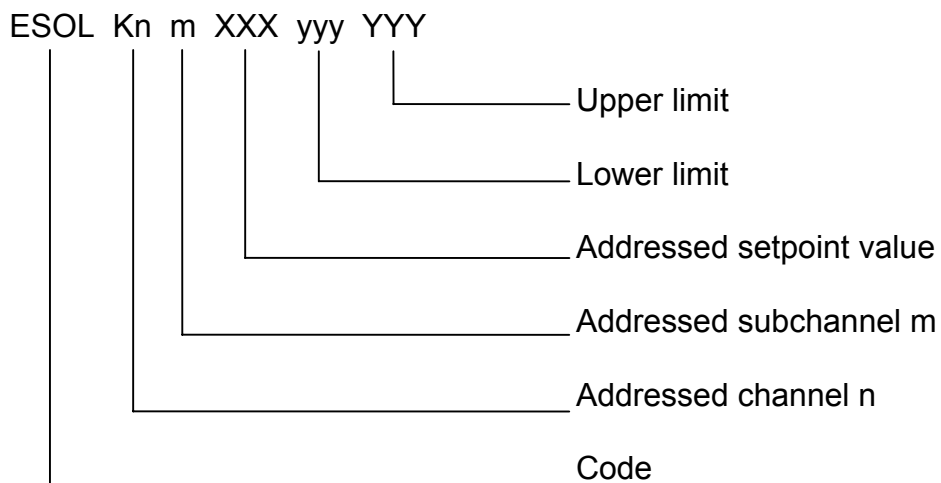

Response

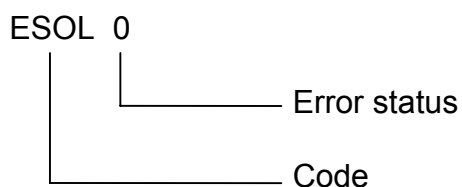

ESYZ – Write command "System time"

With this write command the FU will get the system time (calendar time) that has to be adjusted for the called channel (device).

Write command

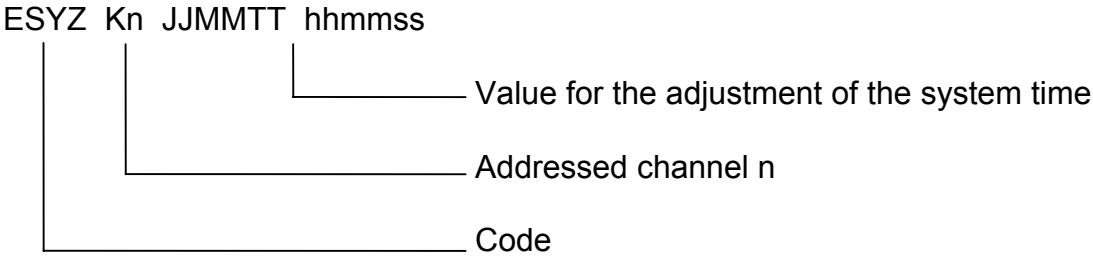

Response

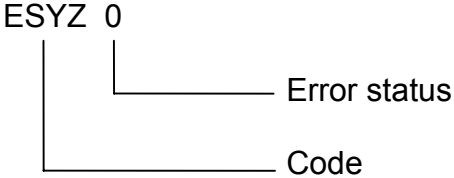

ET90 – Write command "T₉₀ time" (response time)

With this write command the analyzers in a system or the single analyzer will get the t₉₀ time steps in seconds that have to be adjusted for the called channel (device).

Write command

ET90 Kn XXX YYY ZZZ

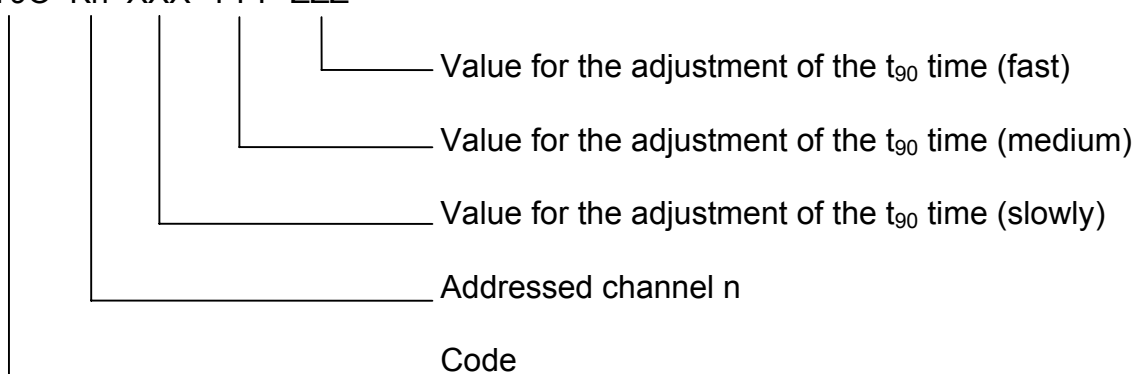

Response

ET90 0

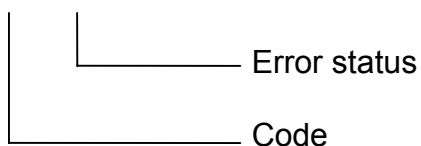

ETOL – Write command "Stability tolerances"

With this write command the analyzers in a system, the single analyzer or the front-end computer will get the required tolerances for functions running stability controlled. The tolerance will be specified in percent of the end of range value. The tolerance can be adjusted for each range separately. No tolerance check will be done, if the tolerance value will be set to T = 100%.

Write command

ETOL Kn M1 Tn1 [...Mm Tnm]

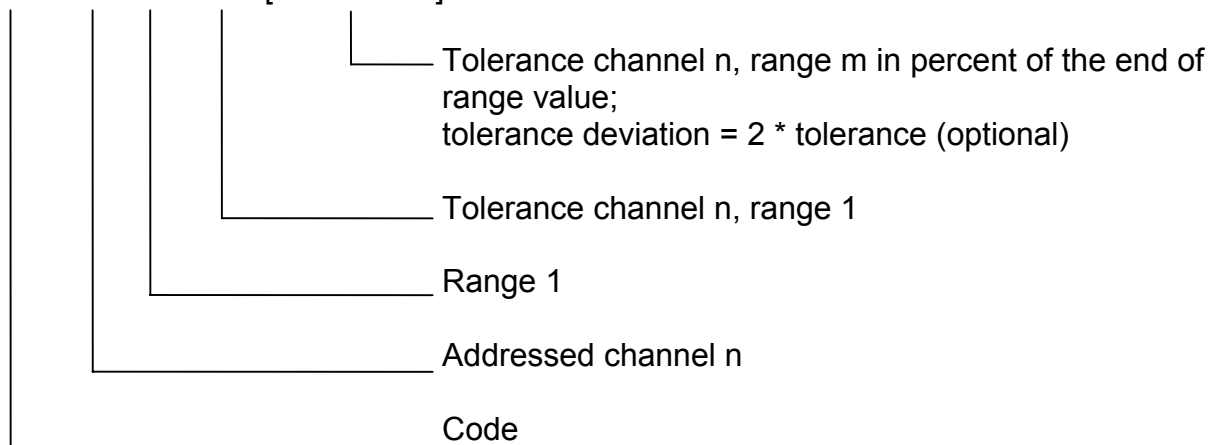

Response

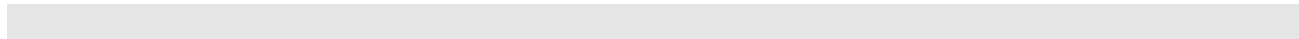
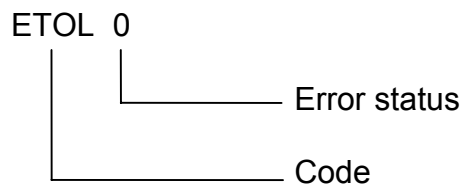

EVEZ – Write command "Delay and synchronization time"

With this write command the analyzers in a system or the single analyzer will get the delay time and the synchronization time for the called channel (device). The delay time will be used for integrators started by "SINT" or for the delayed record of valid signals. The synchronization time will be used for the output of values that were read by "AKON", "AIKO" and "AIKG" from an internal buffer. The same synchronization time will also delay the analog signal of these values. This procedure will be started by the control command "SRON" or will be finished by the control command "SROF".

Write command

EVEZ K0 XXX YYY

EVEZ Kn XXX YYY

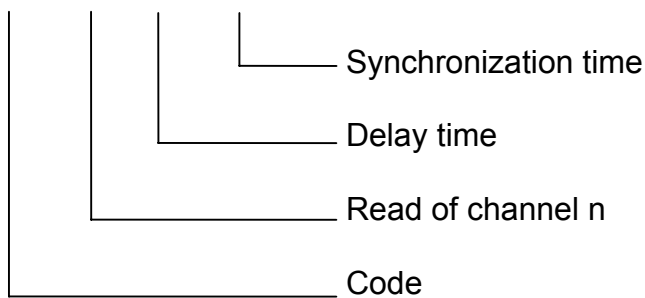

Response

EVEZ 0

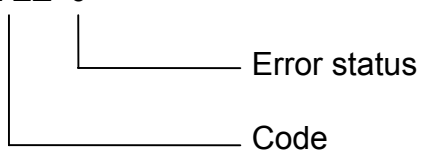

II) V24/RS232/485 Interface - Single Analyzers and Systems

EZEI – Write command "Times"

With this write command the FU will get the times that have to be adjusted in the called channel (device) for the automatic start of functions or procedures (e.g. "Automatic calibration"). Furthermore, the FU will get the function length in seconds.

The following controls will be possible:

- If the calendar day will be mentioned, the function will start only once at one date. If the calendar day will be missing, the function will start each day.
- The clock time as starting time and the function length have always to be mentioned.
- If the function length will be zero, the function will run without any time limit. Then it can only be finished by another control command. A function length of the write command "EFDA" will not be used here.
- Unused data will be replaced by "#".

If the functions shall start several times automatically at the same day, the times can be set up in blocks one after another (maximum 4 digits).

Functions with day information will be deleted automatically after they will be ready. Otherwise, the set-ups of functions will be deleted by resetting all values to zero.

Examples:

- CODE 871113 171200 0: The adjusted function will be started for one time at 13/11/87, 5 o'clock p.m. (17 o'clock), 12 minutes and 0 seconds. The function length will be unlimited.
- CODE 871113 171200 33: The adjusted function will be started for one time at 13/11/87, 5 o'clock p.m. (17 o'clock), 12 minutes and 0 seconds. The function length will be limited to 33 sec.
- CODE # 051208 0: The adjusted function will be started each day at 5 o'clock a.m., 12 minutes and 8 seconds. The function length will be unlimited.
- CODE # 051200 1850: The adjusted function will be started each day at 5 o'clock a.m., 12 minutes and 0 seconds. The function length will be limited to 1850 seconds.
- CODE # 060000 100 # 120000 0 # 180000 0 # 240000 150: The adjusted function will be started each day at 6, 12, 18 (6 p.m.) and 24 (12 p.m.) o'clock.

Write command

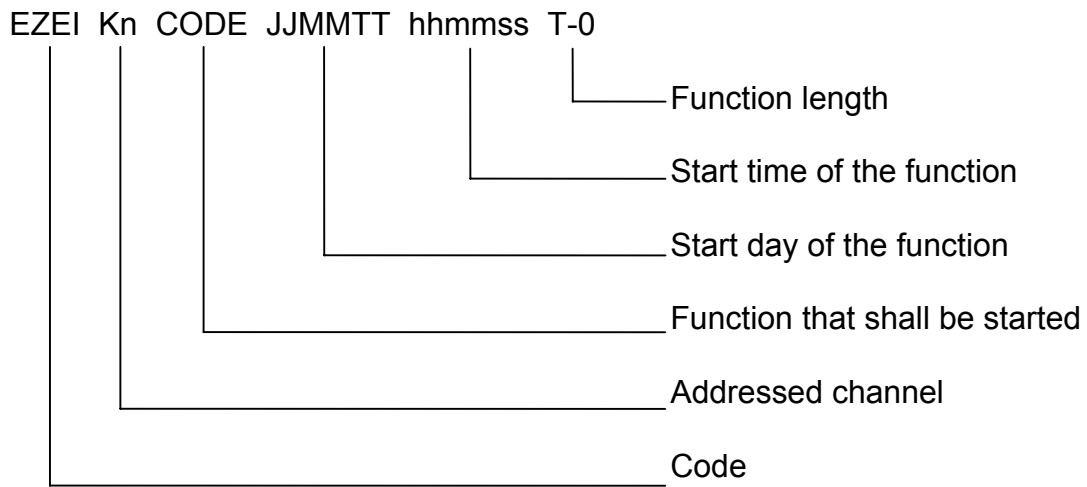

Response

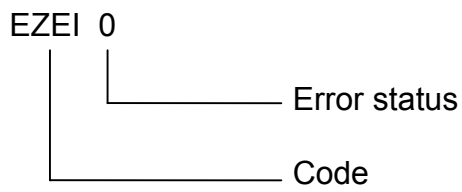

1. Overview about working AK commands in NGA devices

Code	Function	MLT local V3.2	MLT/CU V3.2	Other AM V3.2
AAEG	Deviation to span gas	√	√	
AALI	Linearization check results	√	√	
AANG	Deviation to zero gas	√	√	
ABST	Hours of operation	√	√	
ADRU	Pressure	√	√	√
ADUF	Flow	√	√	√
AEMB	Actual range number	√	√	√
AFDA	Function length	√	√	
AGID	Device identification	√	√	√
AGRW	Limits	√	√	
AIKG	PV average (Concentration integral value); all	√	√	
AIKO	PV average (Concentration integral value); partial	√	√	
AKAK	Span gases	√	√	√
AKAL	Calibration results	√	√	
AKEN	Tag	√	√	
AKFG	System configuration	√	√	√
AKON	Concentration	√	√	√
AKOW	Calibration values (Correction for zero and gradient)	√	√	
ALCH	Linearization check results	√	√	
ALIK	Calculation of linearization curve	√	√	
ALIN	Linearization x/y-values	√	√	
ALKO	Linearization polynomial coefficients	√	√	√
ALST	Linearization steps	√	√	
AM90	Actual t90 time	√	√	
AMBA	Begin of ranges	√	√	√
AMBE	End of ranges	√	√	√
AMBU	Switch levels for autorange	√	√	
AMDR	Manual pressure value	√	√	
APAR	Parameters general			
AQEF	Cross interference check result	√	√	
ASOL	Setpoints with limits	√	√	
ASTA	Internal status	√	√	
ASTF	Internal error status	√	√	
ASTZ	Action status (running procedure)	√	√	
ASYZ	Time and date of the system	√	√	√
AT90	t90-times	√	√	
ATEM	Temperature	√	√	√
ATOL	Tolerances for stability controlled procedures	√	√	
AUKA	Uncorrected, analog PV value	√	√	√
AVEZ	Delay and synchronization time	√	√	
AZEI	Times for procedures	√	√	
EFDA	Function length	√	√	
EGRW	Limits	√	√	
EKAK	Span gases	√	√	√
EKEN	Tag	√	√	
EKFG	System configuration	√	√	√
ELIN	Linearization x/y-values	√	√	

Code	Function	MLT local V3.2	MLT/CU V3.2	Other AM V3.2
ELKO	Linearization polynomial coefficients	√	√	√
ELST	Linearization steps	√	√	
EMBA	Begin of ranges	√	√	√
EMBE	End of ranges	√	√	√
EMBU	Switch levels for autorange	√	√	
EMDR	Manual pressure value	√	√	
EPAR	Parameters general			
ESOL	Setpoints with limits	√	√	
ESYZ	Time and date of the system		√	√
ET90	t90 times	√	√	
ETOL	Tolerances for stability controlled procedures	√	√	
EVEZ	Delay and synchronization time	√	√	
EZEI	Times for procedures	√	√	
SALI	Linearization check with span gases	√	√	
SARA	Autoranging OFF	√	√	
SARE	Autoranging ON	√	√	
SATK	Zero and span calibration	√	√	
SCAL	Start system calibration		√	
SEGA	Open spangas valve	√	√	
SEMB	Set range	√	√	√
SENO	Switch to NO mode for CLD module			√
SFRZ	Floating point format of real numbers	√	√	√
SGTS	Switch to device test status			
SHDA	Hold mode OFF	√	√	
SHDE	Hold mode ON	√	√	
SINT	Start integration	√	√	
SLCH	Start linearization check	√	√	
SLIN	Start linearization	√	√	
SLST	Switch linearization step	√	√	
SMAN	Communication: Manual	√	√	
SMGA	Open sample gas valve	√	√	
SNAB	Zero calibration	√	√	√
SNGA	Open zero gas valve	√	√	
SNOX	Switch to NOx mode for CLD module			√
SPAB	Span calibration	√	√	√
SPAU	Set to pause mode	√	√	
SQEF	Start cross interference measurement	√	√	
SREM	Communication: Remote	√	√	
SRES	µP-Reset	√	√	√
SROF	Delay mode OFF	√	√	
SRON	Delay mode ON	√	√	
SRUC	Purge backwards			
SSPL	Open purge gas valve	√	√	
ST90	Set t90 time	√	√	
STBY	Set to stand-by	√	√	
Implemented additional Fisher-Rosemount specific commands (not official AK):				
ALIK, AMBA, AMDR				
EMBA, EMDR				
SCAL, SFRZ, SHDA, SHDE, SNAB, SPAB				
ASVC, ESVC, SSV, (additional service commands)				

2. AK Service Commands

ASVC K0 S599 ExactNode Name	Reading of LON variables of a network node
------------------------------------	--

Description: This command is an enlarged alternative to the S600 command. It may use the variables of all network nodes, even if they will not be analyzer modules. You only have to know the right node address (cf. S632).

Syntax: ExactNode = Right network node address
Name = Name of the variable

Response: ASVC 0 a
a: Value of the desired variable

Notes: Only texts without an AK separating sign will be valid as variable names.
The "ExactNode" is an address composed from a node address and its subnode address.

The formula is: $\text{ExactNode} = \text{Subnode} * 256 + \text{Node};$

Example: Node = 2 Subnode = 1 $\text{ExactNode} = 1 * 256 + 2 = 258$

Cf.: S600, S630, S632

ESVC K0 S599 ExactNode Name a	Writing from a LON variable of a network node
--------------------------------------	---

Description: This command is an enlarged alternative to the S600 command. It may use the variables of all network nodes, even if they will not be analyzer modules. You only have to know the right node address (cf. S632).

Syntax: ExactNode = Right network node address
Name = Name of the variables
a = Value of the variable

Notes: Only texts without an AK separating sign will be valid as variable names.
The "ExactNode" is an address composed from a node address and its subnode address.

The formula is: $\text{ExactNode} = \text{Subnode} * 256 + \text{Node};$

Example: Node = 2 Subnode = 1 $\text{ExactNode} = 1 * 256 + 2 = 258$

Cf.: S600, S630, S632

SSVC K0 S599 ExactNode Name a	Writing from a LON variable of a network node without checking the range of values
--------------------------------------	---

Description: This command corresponds to "ESVC K0 S599...", only without checking the range of values.

S600: Access to LON network variables

Access to network variables of an analyzer module.

Notes:

☞ If a variable will contain several values (array), you can access to these values by adding the corresponding number directly to the name of the variable.

Example: LINYA = [31, 44, 54]

```
LINYA1 = 31
LINYA2 = 44
LINYA3 = 54
```

☞ The network variable knows its data type. The AK command will try to convert the text of value inputs to the required type. Only if this will not be possible a syntax error will be reported.

☞ If the data will be of the so-called "enum" type, the value will have to be inputted as integer. The text on the display cannot be used, because this text information is only existing in the control unit. To find out the integer value corresponding to a certain "enum" text, you have to look into the EXCEL-File. In the EXCEL-File the first column of the "enum" text will correspond to the value "0", the next column to the value "1" etc.

ASVC Kn S600 Name	Reading of the variable value
-------------------	-------------------------------

Syntax: Name = Name of the variable

Response: ASVC 0 a
a: Value of the desired variable

Note: Only texts without an AK separating sign will be valid as variable names.

Cf.: S630 (which variables are existing ?)

ESVC Kn S600 Name a	Writing of the variable value
---------------------	-------------------------------

Syntax: Name = Name of the variable
a = Value of the variable

Cf.: S630 (which variables are existing ?)

SSVC Kn S600 Name a	Writing of the variable value without checking the range of values
---------------------	---

Description: This command corresponds to "ESVC Kn S600...", only without checking the range of values.

SSVC Kn S621 a

Loading/Saving of device specific parameters

Description: With this command you can load/save the device specific parameters. This will be possible via the serial interface and from /to the internal FLASH memory (if on ACU available!).

Syntax:

a =	1:	loading new configuration via the serial interface.
	2:	sending out the current configuration via the serial interface
	3:	saving the current configuration in the FLASH memory
	4:	loading the configuration saved in the FLASH memory

Notes: The data format for the loading via the serial interface (a = 1) corresponds to the data format of the serial sending out (a = 2).

Some peculiarities will have to be heeded, because the serial interface will be used parallel for AK and for in-/output of the data stream:

For a = 1 you will have to wait for the AK response, before you will start the sending of the data stream.

not For a = 2 the AK response ("`<STX><don't care>SSVC 0<ETX>`") will be sent at first. It will be necessary to treat these response signs in a certain way, because this line will be deleted as invalid stream!

Saving the configuration in the FLASH memory (a = 3) will overwrite the factory settings of the device !!

With a = 4 the factory settings will be reloaded to the RAM memory and so to the actual working memory.

Cf.: Instruction manual

ASVC Kn S630

Output of the LON variable names

Description: All LON variables that are available in an analyzer module will be sent out with their names. If a variable will contain several values (array), it will be marked by an appendix in brackets. In these brackets you will find the numbers to access to the array values of the variable.

Example: LINYA[1-7] contains 7 values. You can access to these values with the names LINYA1, LINYA2, ... LINYA7.

Notes: K0 is not possible.

all At the moment the command is implemented in a way that it will send out for each channel variables available in the certain module. That means that variable names may exist multiplex. These multiplex available variables will be separated internal and each will be assigned to another channel (subnode). If variables will not exist multiplex, these variables will only exist once. That means that a changing within a channel will have an effect as changing of the other channels.

Cf.: S600 (Access to network variables)

ASVC Kn S631

Output of the LON node informations

Syntax: ASVC Kn S631

Response: ASVC 0 <name> <version> <node-number> <subnode-number>

ASVC Kn S632

Output of the LON node informations of all nodes

Syntax: ASVC K0 S632

Response: ASVC 0 <ExactNode> <NodeTag>
ExactNode = Exact node address in the network
NodeTag = Tag string of this node

Notes: The "ExactNode" is an address composed from the node address and its subnode address.

The formula is: $\text{ExactNode} = \text{Subnode} * 256 + \text{Node};$

Example: ExactNode = 258
Subnode = $\text{ExactNode} \bmod 256 = 1$
Node = $\text{ExactNode} - ((\text{ExactNode} \bmod 256) * 256) = 2$

Cf.: S599, S600, S630

ASVC Kn S640 a

Output of values of the MLT concentration formula

Concentration formula:

$$\text{Conce} = \text{FacP} * \text{FacT} * \text{FacSpan} * \text{Lin}\{(\text{RawAvg} - \text{OffP} - \text{OffT} - \text{OffX}) * \text{RGain} * \text{Gain}\}$$

Meaning of the variables:

RawAvg:	Raw value average (including t_{90} time)
OffP:	Offset correction of physics
OffT:	Offset correction of temperature
OffX:	Offset correction of interferences from other channels
RGain:	Analog pre amplifying factor (BIS)
Gain:	Factor standardizing to the desired setpoint value (span)
Lin:	Linearization procedure
FacSpan:	Span factor standardizing the product "FacP*FacT*FacSpan" to 1.0 during the span cal.
FacT:	Temperature correction in the sensitivity
FacP:	Pressure correction in the sensitivity
Conce:	Concentration value

Syntax: ASVC Kn S640 a

Response: ASVC 0 <value1> <value2> ...

a = 0: value1 = RawCount = uncorrected signal
value2 = RawAvg
value3 = OffT
value4 = OffX
value5 = OffP
value6 = Gain
value7 = RGain

a = 1: value1 = LinInput = (RawAvg - OffP - OffT - OffX) * RGain * Gain
value2 = LinOutput = Lin{(RawAvg - OffP - OffT - OffX) * RGain * Gain}
value3 = FacSpan
value4 = FacT
value5 = FacP
value6 = Conce

a = 2: value1 = Temperature for OffT
value2 = Temperature for FacT
value3 = Atmospheric pressure for FacP

NGA 2000 MLT AK Protocol

Instruction Manual

90003752

11/2003

**WORLD HEADQUARTERS
ROSEMOUNT ANALYTICAL EUROPE
Emerson Process Management
GmbH & Co. OHG**

Industriestrasse 1
63594 Hasselroth
Germany
T 49 6055 884 0
F 49 6055 884209

**Emerson Process Management
Rosemount Analytical Inc.**

6565 P Davis Industrial Parkway
Solon, OH 44139 USA
T 440.914.1261
Toll Free in US and Canada 800.433.6076
F 440.914.1271
e-mail: gas.csc@EmersonProcess.com
www.raihome.com

**GAS CHROMATOGRAPHY CENTER
AND LATIN AMERICA**

**Emerson Process Management
Rosemount Analytical Inc.**

11100 Brittmoore Park Drive
Houston, TX 77041
T 713 467 6000
F 713 827 3329

EUROPE, MIDDLE EAST AND AFRICA

**Emerson Process Management
Shared Services Limited**

Heath Place
Bognor Regis
West Sussex PO22 9SH
England
T 44 1243 863121
F 44 1243 845354

ASIA-PACIFIC

**Emerson Process Management
Asia Pacific Private Limited**

1 Pandan Crescent
Singapore 128461
Republic of Singapore
T 65 6 777 8211
F 65 6 777 0947
e-mail: analytical@ap.emersonprocess.com