

# 7 Series Flame Arrestor

## Table of Contents

- Introduction..... 1
- Specifications ..... 2
- Principle of Operation..... 3
- Factors Affecting Flame Arrestor Performance ..... 3
- Installation ..... 5
- Maintenance..... 6
- Recommended Spare Parts ..... 10
- Parts Ordering ..... 10
- Parts List..... 10



Figure 1. 7 Series Flame Arrestor

**WARNING**

Failure to follow these instructions or to properly install and maintain this equipment could result in an explosion, fire and/or chemical contamination causing property damage and personal injury or death.

Enardo flame arrestors must be installed, operated and maintained in accordance with federal, state and local codes, rules and regulations and Emerson Process Management Regulator Technologies Tulsa, LLC (Emerson™) instructions.

Call a qualified service person to service the unit. Installation, operation and maintenance procedures performed by unqualified person may result in improper adjustment and unsafe operation. Either condition may result in equipment damage or personal injury. Only a qualified person shall install or service the 7 Series flame arrestor.

## Introduction

### Scope of the Manual

This Instruction Manual provides specifications, installation and maintenance instructions and parts ordering information for the 7 Series flame arrestor.

### Product Description

7 Series flame arrestors are designed to stop the propagation of confined low pressure deflagration. The 7 Series is typically used for end-of-line and near-end-of-line applications when the system operating pressure is near atmospheric levels and when there is minimal probability of a flame stabilizing on the flame arrestor element for an extended period.

Designed with flanged connections, this arrestor allows removal of the flame cell element for easy cleaning and replacement without removing the arrestor body from the pipe connection. Standard housing construction is aluminum, carbon steel or

North America Only

# 7 Series

## Specifications

The Specifications section lists the specifications for the 7 Series. Specification is stamped on the nameplate attached to the flame arrester.

<p><b>Available Construction</b> See Table 1 and Figure 2</p> <p><b>Gas Group</b> B, C and D</p> <p><b>Flange Size and Rating</b> 1 to 36 in. / 25 to 900 mm CL150 FF and RF</p> <p><b>Housing Size</b> 4 to 72 in. / 100 to 1800 mm</p> <p><b>Temperature Rating of Gaskets<sup>(1)</sup></b> Fiber Gaskets (standard): 450°F / 232°C Graphite Gaskets (Optional): Higher temperature</p>	<p><b>Pipe Length</b> See Table 4</p> <p><b>Housing Material</b> Aluminum, Carbon steel, 304 Stainless steel, 316 Stainless steel and Hastelloy®</p> <p><b>Cell Material</b> Aluminum, 304 Stainless steel, 316 Stainless steel and Hastelloy®</p>
--	--

1. The pressure/temperature limits in this Instruction Manual and any applicable standard or code limitation should not be exceeded.

7									
7 Series	Housing Size	Connection Size	NEC	Housing Material	Element Material	Connection Type	Options		
Blank = Concentric E = Eccentric	04 = 4 in. through 72 = 72 in.	01 = 1 in. through 36 = 36 in.	Gas Group B C D	A = Aluminum C = Carbon steel 4 = 304 SST 6 = 316 SST H = Hastelloy® E = Exotic	A = Aluminum 4 = 304 SST 6 = 316 SST H = Hastelloy® E = Exotic	F = Flat face flange R = Raised face flange	1 = Drain Port 2 = Pressure Tap 3 = Temperature Probe Tap 4 = Miscellaneous 5 = Protective Coating 6 = Special Feature		

Figure 2. 7 Series Flame Arrester Available Constructions and Model Numbering System

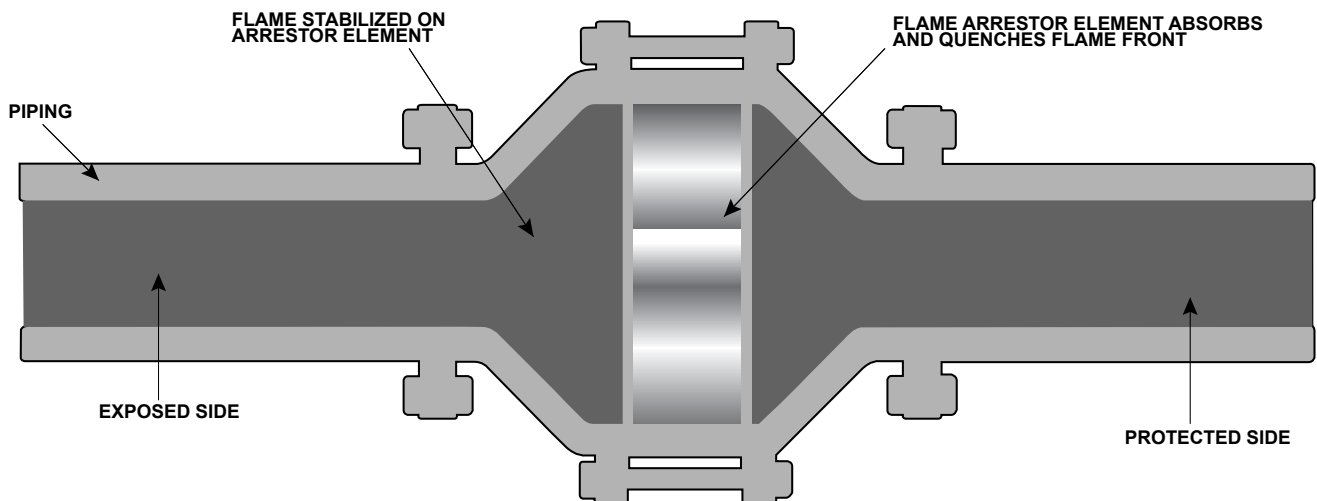

Figure 3. Flame Arrester Operation

Hastelloy® is a mark owned by Haynes International, Inc.

Table 1. 7 Series Available Construction

7 SERIES IN-LINE FLAME ARRESTOR CARBON STEEL AND STAINLESS STEEL HOUSINGS CONSTRUCTION				
Model	Flange Size		Housing Size	
	In.	mm	In.	mm
70401	1	25	4	100
70402	2	50	4	100
70602	2	50	6	150
70802	2	50	8	200
70603	3	75	6	150
70803	3	75	8	200
70804	4	100	8	200
71006	6	150	10	250
71206	6	150	12	300
71408	8	200	14	350
71608	8	200	16	400
71810	10	250	18	450
72010	10	250	20	500
72212	12	300	22	550
72412	12	300	24	600

7 SERIES IN-LINE FLAME ARRESTOR ALUMINUM HOUSING CONSTRUCTION				
Model	Flange Size		Housing Size	
	In.	mm	In.	mm
70802	2	50	8	200
70803	3	75	8	200
70804	4	100	8	200
71006	6	150	10	250
71206	6	150	12	300
71408	8	200	14	350
71608	8	200	16	400
72010	10	250	20	500
72212	12	300	22	550
72412	12	300	24	600

stainless steel. The element is available in stainless steel. Special material and protective coating are available on request.

## Principle of Operation

Flame arrester allows gas to pass through it but stops flame in order to prevent a larger fire or explosion. Arrester prevents flame by absorbing and dissipating the heat from flame as it attempts to travel through the spiral wound crimped ribbon flame cells. These cells allow maximum flow with maximum protection.

## Factors Affecting Flame Arrester Performance

### Gas Group



### WARNING

Methanol is classified by the National Electrical Code (NEC) as a Group-D vapor. However, our lab tests indicate that methanol exhibits characteristics unlike other Group-D vapors under certain conditions. We therefore recommend that an arrester rated for Group-C vapors be specified for methanol service.

# 7 Series

**Table 2. Maximum Experimental Safe Gap (MESG)**

NATIONAL ELECTRICAL CODE (NEC)	MESG		TEST GAS LIST
	In.	mm	
Group B	0.011	0.28	Hydrogen
Group C	0.026	0.65	Ethylene
Group D	0.035	0.90	Propane

**Table 3. 7 Series Flame Arrestor Endurance Burn Time**

GAS GROUP	MAXIMUM INITIAL PRESSURE		ENDURANCE BURN TIME
	psia	kPa	
D	15.4	106	30 minutes (Steel and Stainless steel models up to 12 in. and under)
D	15.4	106	5 minutes (all other Group-D)
C	15.4	106	5 minutes
B	15.4	106	2 minutes

The type of gas in the system determines its gas grouping and therefore predetermines the type of arrestor element required. The element must be designed to accommodate the specific gas group that could possibly ignite and propagate in the system. The more explosive gases require the flame cell to absorb the heat more quickly and efficiently. The National Electrical Code (NEC) groups gases into A, B, C, D and G.M. categories depending on the Maximum Experimental Safe Gap (MESG) of the gas.

## Maximum Experimental Safe Gap (MESG)



### WARNING

**Verify that the Flame Arrestor being installed has the appropriate gas group rating for your process. This information is shown on the nameplate attached to the element housing. Do not remove or alter this nameplate.**

The measurement of the maximum gap between two equatorial flanges on a metal sphere that will prevent a flame from being transmitted from the sphere to the surrounding flammable mixture. MESG is dependent on gas composition. The stoichiometric mixture (the ideal air/fuel ratio for the most efficient combustion) is used to determine the minimum MESG for a given gas. See Table 2 for the MESG per gas group.

## Maximum Initial Operating Pressure

This is the pressure of the system at or near static flow conditions. High pressure deflagration can occur more easily at higher system operating pressures than at pressures near atmospheric. Elevated pressures condense the ignitable gas giving the flame more matter and energy to release thereby boosting the flame heat intensity. Verify that your system pressure at or near static flow conditions does not exceed the maximum pressure shown on the arrestor's name tag.

## Endurance Burn Time



### WARNING

**Unlimited burning should not be allowed in any flame arrestor, regardless of its burn time rating. If burning can occur for a period exceeding 2 minutes starting at ambient temperature, it is recommended that a temperature alarm and shutdown system be installed.**

Endurance burn time is the time it takes for a stabilized flame, at greatest heat saturation conditions, to heat the arrestor element above the auto-ignition temperature of the process gas stream resulting in flame propagation through the arrestor. See Table 3 for the 7 Series endurance burning time.

**Table 4. 7 Series Pipe Length Rules**

	GAS GROUP "B"	GAS GROUP "C"	GAS GROUP "D"
Maximum length of pipe between the flame arrestor and the ignition source without bends or other obstructions.	4 ft. / 1.2 m., open ended pipe	6 ft. / 2 m., open ended pipe	20 ft. / 6 m.
Maximum length of pipe between the flame arrestor and the ignition source with a maximum of one 90° bend. Multiple bends or any additional obstructions are not recommended.	Not Recommended With a Bend.	6 ft. / 2 m., open ended pipe	20 ft. / 6 m.

## Pipe Lengths

Extended lengths of pipe allow the flame to advance into more severe states of flame propagation such as high pressure deflagration or detonations. 7 Series Flame Arrestors should be installed in accordance with the Table 4.

## Bends and/or Flow Obstructions



**For maximum safety, avoid bends and flow obstructions within 10 pipe diameters on the protected side of the flame arrestor.**

Bends in piping, pipe expansions and/or contractions, valves, orifice plates or flow obstructing devices of any kind contribute to turbulent flow. Turbulent flow enhances mixing of the combustible gases, greatly increasing the combustion intensity. This can result in increased flame speeds, higher flame temperatures and higher flame front pressures than would occur in normal flow conditions.

## Installation



**Always make sure that the system is at atmospheric pressure and there is no ignitable gas that could flash when either installing or maintaining the unit.**

## Connection

Enardo flame arrestors are normally provided with CL150 raised or flat face flanges. Other flange patterns are available upon request. Make sure the companion flanges installed in adjacent piping match the flanges on the flame arrestor.

Standard compressed fiber gaskets that withstands temperatures of 450°F / 232°C are standard. Graphite gaskets with higher temperature ratings are available as an option.

## Positioning



**The flame arrestor is fitted with lugs for lifting the element assembly during servicing operations. These lugs are not intended for lifting the entire unit during installation. Damage to the flame arrestor may result from improper lifting. Heavy units should be lifted using appropriately rated Nylon (PA) straps rigged on the outside of the tension studs.**

The flame arrestor should be positioned such that the element is accessible for removal. The tension studs are supplied with jacking nuts on one half of the bolting circumference. Install the unit so that the jacking nuts (on the inside of the studs) are positioned on the opposite side from the direction that the element assembly will be removed.

Models that have drain plugs are designed for horizontal installation and should be installed with the drain plugs aligned at the bottom of the unit. Models that have pressure taps are designed to allow pressure gauges to be installed on both sides of the flame cell assembly to determine blockage. The pressure taps should be aligned at the top to allow easy viewing of the gauges. Units that are equipped with optional internal cleaning systems should be connected to a source of cleaning media such as water, steam or other suitable solvent.

## Flow Direction

The Enardo flame arrestor is bi-directional and can be installed either vertically or horizontally. Consideration should be given to non-symmetrical assemblies that

# 7 Series

include features such as clean-out ports, temperature monitoring device or other options that might have a preferred installation direction to suit the needs of the customer.

## Piping Expansions and Reductions Adjacent to Flame Arrestors



### WARNING

**No instrument, tubing or other device whatsoever shall circumvent the flame arrestor in such a manner to allow a flame path to exist around the flame element of the arrestor. When instrumentation is installed in such a manner that it creates a path circumventing the flame element of an arrestor, measures must be taken to prevent passage of flame through the instrumentation device and/or system. Instrumentation must be capable of withstanding the maximum and minimum pressures and temperatures to which the device may be exposed.**

An Enardo flame arrestor may be installed in any vapor control line that is smaller than or equal to the nominal pipe diameter of the arrestor's connection flanges.

When it is necessary to increase the diameter of the piping on the downstream side of the flame arrestor, a length of pipe at least 120 pipe diameters must be installed between the flame arrestor and the expansion. A pipe diameter is considered as the inside diameter of pipe having a nominal size equal to the flame arrestor's connecting flanges.

## Maintenance



### WARNING

**Flame cells must be inspected for damage immediately following a deflagration and/or stabilized burn.**

1. Carefully remove the element assembly from the arrestor and place it on a soft surface such as plywood.
2. Inspect the flame cell visually for any signs of corrosion or other damage.

3. Inspect the flame cell with a calibrated pin gauge to ensure maximum crimp size openings do not exceed the following values for their respective gas group:
  - Explosion Group D – 0.051 in. / 1.3 mm
  - Explosion Group C – 0.038 in. / 0.965 mm
  - Explosion Group B – 0.017 in. / 0.432 mm
4. If any damage is noted, or crimp openings exceed maximum size allowable, replace the element assembly.
5. Keep the element openings clean to prevent loss of efficiency in absorbing heat. Remove the element assembly and clean the elements to prevent the openings from becoming clogged with particulate matter. Clean the element with a suitable cleaning media (solvent, soap, water or steam) then blow dry using compressed air. Be careful not to damage or dent the cell openings as this would hamper the effectiveness of the unit. Do not clean the arrestor elements by rodding to remove blockages, as this practice will damage the elements and seriously impair the arrestor's performance. If the arrestor element cannot be cleaned satisfactorily, replace it.
6. For best cleaning results, use a high pressure sprayer with spray wand (1500 to 3000 psig / 103 to 207 bar) to clean the entire element surface. Hold the spray nozzle perpendicular to the surface being cleaned to maximize spray media penetration into the element. Alternately spray each side of the element surface until clean.
7. The cleaning interval should be governed by the amount and type of particulate in the system to which it is installed and must be determined by the user. To determine the maintenance interval, the user should check the element in the first few months of operation to find how quickly particulate accumulates in the cells.
8. After cleaning, thoroughly inspect the element for damage. If damaged, replace it.

### Note

**Under no circumstance should the element bank be disassembled from its shell for cleaning or replacement. The element section must be replaced as a complete assembly.**

**Cleaning of units equipped with this system may be accomplished in several ways including periodic cleaning using manually operated valves, by use of**

an automated cycle timing method or by having the cleaning operation initiated whenever the pressure loss across the arrestor element exceeds a predetermined value.

## Element Assembly, Disassembly and Reassembly Instructions

### WARNING

**Isolate gas supply and bring system to atmospheric pressure to prevent ignitable gas from flashing while performing maintenance.**

1. Loosen all jacking (inside) nuts on tension studs between conical sections of the flame arrestor.
2. Tighten the inside jacking nuts on the tension studs forcing the two conical sections apart. When the two flange faces have separated, remove the tension studs that do not have inside jacking nuts so that the element assembly can be removed. The inside jacking nuts are installed on all tension studs that facilitate jacking the unit apart. The inside jacking nuts are not installed on tension studs that are taken out, for ease of removal.

### CAUTION

**Element assemblies are heavy and will require the use of adequate equipment and manpower to prevent injury.**

3. Thoroughly clean the gasket sealing faces being careful not to damage the sealing surface. For reassembly, lightly grease one side of a new gasket and place it in the machined recess of each interior flange on the two conical sections.
4. Replace the flame element assembly with a new assembly or properly cleaned and inspected existing unit.
5. Loosen the jacking nuts on the tension rods until the flame cell assembly seats onto the gaskets.
6. Replace all tensioning studs and hand tighten the outer nuts. Check to be sure that all the jacking nuts are completely loose and not making contact with the flange face.

## Torquing Instruction

### CAUTION

**Excessive or uneven torquing can cause permanent damage to gaskets and housing.**

### *Tools/Supplies Required*

- Torque wrench appropriate for the specified torque
- Socket wrenches of the proper size to fit the hex nuts being tightened
- Molydisulfide based lubricating paste, Molykote® G-n or equivalent
- Brush suitable for applying lubricant to the studs
- Wiping rags necessary for the clean up of excessive lubricant

### *Procedure*

1. Use studs and nuts that are free of visible contamination and corrosion.
2. Apply lubricant to the threads of the stud protruding outboard of the interior flanges and to the face of the hex nuts which will contact the flange.
3. Assemble the nuts to the studs such that the amount of thread extending outboard beyond the nut is approximately equal on both ends.
4. Tighten the nuts to the torque values shown in Table 5 following the designated sequence, repeating the sequence as shown. Flange pattern tightening sequences are shown in Figure 4.

### *Bolt Lubrication*

Lubrication will affect required torque of clean fasteners in good condition more than any other factor. In fact, 90% of applied torque goes to overcome friction while only 10% actually stretches the bolt. Table 5 assumes that only machine oil is used as a lubricant. Table 6 shows a list of several common lubricants and their effect on torque required to stretch bolts to 50% of their yield strength. Most are available from local bearing distributors.

# 7 Series

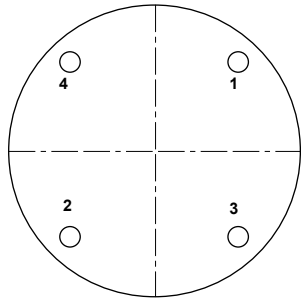

PATTERN 1

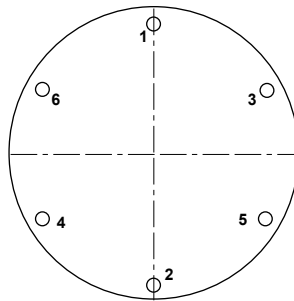

PATTERN 2

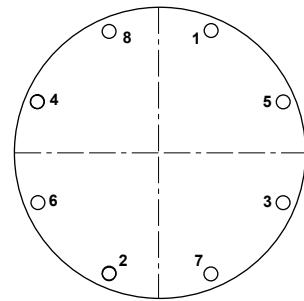

PATTERN 3

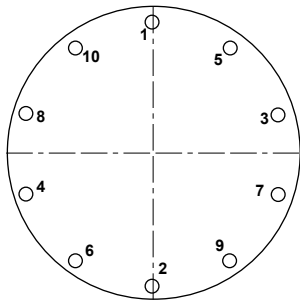

PATTERN 4

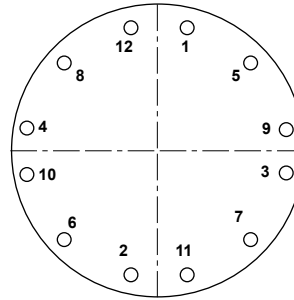

PATTERN 5

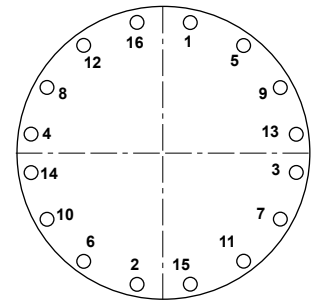

PATTERN 6

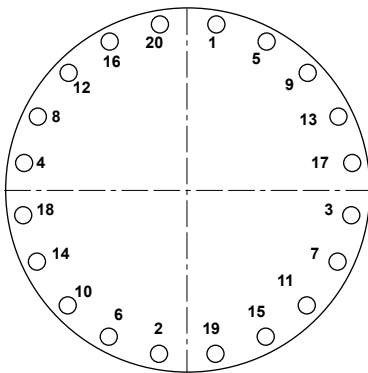

PATTERN 7

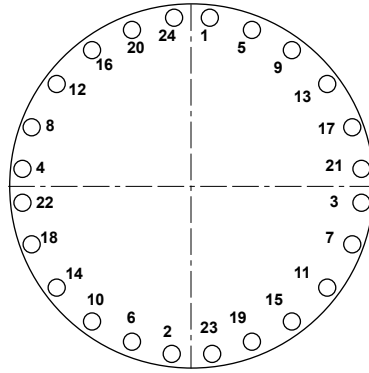

PATTERN 8

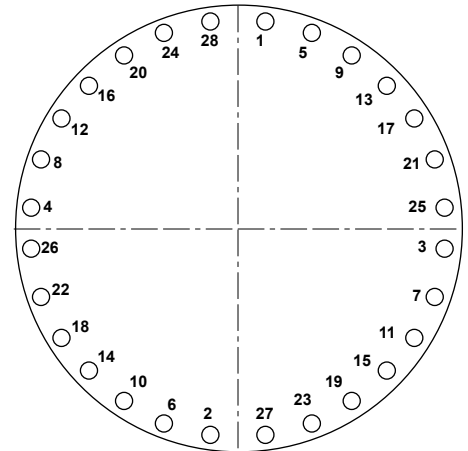

PATTERN 8

North America Only

Figure 4. Flange Pattern Tightening Sequence



**Table 5. Tightening Steps and Torque Values<sup>(1)(2)</sup>**

7 SERIES FLAME ARRESTORS WITH ALUMINUM END SECTIONS ONLY		TIGHTENING STEPS AND TORQUE (LBF-FT / N•m)				
Model	Pattern <sup>(2)</sup>	Step 1	Step 2			
70802-A, 70803-A, 70804-A	1	Snug	25 / 34			
71006-A, 71206-A, 71408-A	2	Snug	25 / 34			
71608-A	3	Snug	25 / 34			
72010-A	3	Snug	50 / 68			
72212-A, 72412-A, 72414-A, 72614-A, 72616-A	5	Snug	50 / 68			
73016-A	7	Snug	50 / 68			
73216-A	8	Snug	50 / 68			
7 SERIES FLAME ARRESTORS WITH STEEL OR STAINLESS STEEL END SECTIONS ONLY		TIGHTENING STEPS AND TORQUE (LBF-FT / N•m)				
Model	Pattern <sup>(2)</sup>	Step 1	Step 2	Step 3	Step 4	Step 5
70401, 70401.5, 70602, 70603, 70604, 70802, 70803, 70804	1	Snug	20 / 27	50 / 68		
71006, 71206	2	Snug	20 / 27	50 / 68		
71408	2	Snug	25 / 34	60 / 81		
71608	3	Snug	25 / 34	50 / 68	80 / 108	
71810	3	Snug	25 / 34	50 / 68	90 / 122	
72010	3	Snug	25 / 34	50 / 68	75 / 102	100 / 136
72212	4	Snug	25 / 34	50 / 68	85 / 115	
72412	4	Snug	35 / 47	70 / 95	100 / 136	130 / 176
72614, 72616	4	Snug	35 / 47	70 / 95	100 / 136	140 / 190
72814	5	Snug	35 / 47	70 / 95	100 / 136	125 / 169
73016	5	Snug	35 / 47	70 / 95	100 / 136	130 / 176
73216	6	Snug	35 / 47	70 / 95	105 / 142	
73420	6	Snug	35 / 47	70 / 95	115 / 156	
7 SERIES FLAME ARRESTORS WITH STEEL OR STAINLESS STEEL END SECTIONS ONLY		TIGHTENING STEPS AND TORQUE (LBF-FT / N•m)				
Model	Pattern <sup>(2)</sup>	Step 1	Step 2	Step 3	Step 4	Step 5
73620	6	Snug	35 / 47	70 / 95	100 / 136	120 / 163
74020, 74024, 74824	7	Snug	35 / 47	70 / 95	130 / 176	
77036	8	Snug	35 / 47	70 / 95	130 / 176	200 / 271

1. Use machine oil as lubricant. See Bolt Lubrication section (Table 6) and torque correction factors for other lubricants.  
2. See Figure 4.

North America Only

**Table 6. Torque Correction Factors for Common Lubricants**

DESCRIPTION	COEFFICIENT OF FRICTION	MULTIPLY TORQUE VALUE IN TABLE 5 BY
Machine Oil	f = 0.15	1.00
API SA2 Grease	f = 0.12	0.80
Never-Seez® (Ni base)	f = 0.11	0.73
Never-Seez® (Cu base)	f = 0.10	0.67
Molykote® G-n Paste	f = 0.06	0.40

Molykote® G-n is a mark owned by Dow Corning Corporation.  
Never-Seez® is a mark owned by Bostik, Inc.

# 7 Series

## Recommended Spare Parts

For installations that require frequent maintenance and minimum downtime, it is recommended that the user purchase a spare element assembly and several spare element gaskets. The spare element assembly can be installed immediately and the dirty assembly can then be cleaned and be stored as a spare for the next maintenance interval.

## Parts Ordering

When corresponding with your local Sales Office about this equipment, always reference the equipment serial number stamped on the nameplate.

When ordering replacement parts, specify the complete 7-character part number of each required part as found in the following parts list.

### Note

**Element gaskets should be replaced each time the cell assembly is loosened and removed to insure a gas tight seal.**

## Parts List

**Table 7. Part Numbers for Replacement Element Assembly Gaskets (for Cast Aluminum End Sections)<sup>(1)</sup>**

MODEL	PART NUMBER	
	Standard Gasket (Compressed Fiber)	High Temperature Gasket (Graphite Coated 316 Stainless Steel)
70802-A, 70803-A and 70804-A	7008102	7049202
71004-A	7008135	7049235
71206-A	7008136	7049236
71408-A	7008124	7049224
71608-A	7008107	7049207

1. Two (2) required per assembly.

**Table 8. Part Numbers for Replacement Element Assembly Gaskets (for All Fabricated End Sections)<sup>(1)</sup>**

MODEL	PART NUMBER	
	Standard Gasket (Compressed Fiber)	High Temperature Gasket (Graphite Coated 316 Stainless Steel)
70400	7008153	7049253
70600	7008134	7049234
70800	7008123	7049223
71000	7008135	7049235
71200	7008136	7049236
71400	7008124	7049224
71600	7008107	7049207
71800	7008108	7049208
72000	7008109	7049209
72200	7008110	7049210
72400	7008111	7049211
72600	7008112	7049212
72800	7008113	7049213
73000	7008114	7049214
73200	7008115	7049215
73400	7008116	7049216
73600	7008117	7049217
73800	7008152	7049252
74000	7008118	7049218
74800	7008133	7049233
77000	7083300	-----

1. Two (2) required per assembly.

**Table 9. Replacement Element Assemblies Part Numbers (Group D Gas)**

HOUSING MATERIAL	Aluminum	Aluminum	Carbon Steel	Carbon Steel	304 Stainless Steel	Carbon Steel	316 Stainless Steel
FLAME CELL MATERIAL	Aluminum	304 Stainless Steel	Aluminum	304 Stainless Steel	304 Stainless Steel	316 Stainless Steel	316 Stainless Steel
MODEL	PART NUMBER						
70400	7011741	7011742	7002246	7002261	7002275	7048509	7002201
70600	7011734	7011735	7048514	7048515	7002279	7048516	7002266
70800	7011704	7011712	7002253	7002203	7002217	7002211	7002202
71000	7011705	7011713	7002254	7002204	7002291	7002214	7002292
71200	7011706	7011702	7002256	7002239	7002233	7002283	7002293
71400	7011707	7011714	7002263	7002228	7002223	7002262	7002268
71600	7011708	7011715	7002248	7002247	7002234	7002280	7002297
71800	7011736	7011737	7002252	7002251	7002289	7002250	7048518
72000	7011709	7011716	7002213	7002249	7048519	7002218	7002296
72200	7011710	7011717	7002240	7002207	7048520	7048510	7048521
72400	7011711	7011718	7002258	7002265	7002232	7002264	7002276
72600	7011703	7011738	7048522	7048523	7048524	7048525	7048526
72800	7011726	7011739	7048505	7048527	7048528	7002281	7048529
73000	7011721	7011740	7002243	7002270	7048530	7048531	7048532
73200	7011732	7011733	7002230	7048533	7048534	7048535	7048536
73400	7011743	7011744	7048537	7002226	7048538	7048539	7048540
73600	7011745	7011746	7048541	7002241	7048542	7048543	7002274
73800	7011747	7011748	7048544	7048545	7048546	7048547	7048548
74000	7011749	7011750	7048549	7002273	7048550	7048551	7002209
74800	7011751	7011752	7048552	7002288	7048553	7048554	7048555

**Table 10. Replacement Element Assemblies Part Numbers (Group C Gas)**

HOUSING MATERIAL	Aluminum	Aluminum	Carbon Steel	Carbon Steel	304 Stainless Steel	Carbon Steel	316 Stainless Steel
FLAME CELL MATERIAL	Aluminum	304 Stainless Steel	Aluminum	304 Stainless Steel	304 Stainless Steel	316 Stainless Steel	316 Stainless Steel
MODEL	PART NUMBER						
70400	7011753	7011754	7048556	7048557	7048502	7048558	7048559
70600	7011755	7011756	7048560	7048561	7048562	7048563	7002231
70800	7011729	7011731	7048507	7002255	7002295	7002206	7048564
71000	7011757	7011758	7048506	7002259	7048501	7048565	7048566
71200	7011759	7011760	7048567	7002260	7048569	7048570	7048571
71400	7011761	7011762	7048572	7048573	7048574	7048575	7002245
71600	7011763	7011764	7048576	7048577	7048578	7048504	7048579
71800	7011765	7011766	7048580	7048581	7048582	7048583	7048584
72000	7011767	7011768	7048585	7002299	7048586	7048587	7048588
72200	7011769	7011770	7048589	7048590	7048591	7048592	7048593
72400	7011771	7011772	7048594	7048595	7048596	7048597	7002244

# 7 Series

**Table 11. Replacement Element Assemblies Part Numbers (Group B Gas)**

HOUSING MATERIAL	Aluminum	Aluminum	Carbon Steel	Carbon Steel	304 Stainless Steel	Carbon Steel	316 Stainless Steel
FLAME CELL MATERIAL	Aluminum	304 Stainless Steel	Aluminum	304 Stainless Steel	304 Stainless Steel	316 Stainless Steel	316 Stainless Steel
MODEL	PART NUMBER						
70400	7011773	7011774	7048598	7048513	7002212	7048512	7002210
70600	7011775	7011776	7048599	7056501	7056502	7056503	7056504
70800	7011725	7011777	7056505	7002216	7002286	7048511	7002215
71000	7011778	7011779	7056506	7002205	7056507	7002290	7056509
71200	7011780	7011781	7056510	7002257	7002282	7056511	7002298
71400	7011782	7011783	7056512	7048508	7056513	7056514	7056515
71600	7011784	7011785	7056508	7056516	7056517	7056518	7056519
71800	7011786	7011787	7056520	7056521	7056522	7056523	7056524
72000	7011727	7011788	7056525	7056526	7056527	7056528	7056529
72200	7011789	7011790	7056530	7056531	7056532	7056533	7056534
72400	7011791	7011792	7056535	7056536	7056537	7056538	7056539

North America Only

**Emerson Process Management  
Regulator Technologies Tulsa, LLC**

9932 East 58th Street  
Tulsa, OK 74146-6411

Tel: +1 918 662 6161  
Fax: +1 918 662 0004

For further information visit [www.enardo.com](http://www.enardo.com)

The Emerson logo is a trademark and service mark of Emerson Electric Co. All other marks are the property of their prospective owners. Enardo is a mark owned by Regulator Technologies Tulsa, LLC, a business of Emerson Process Management.

The contents of this publication are presented for informational purposes only, and while every effort has been made to ensure their accuracy, they are not to be construed as warranties or guarantees, express or implied, regarding the products or services described herein or their use or applicability. We reserve the right to modify or improve the designs or specifications of such products at any time without notice.

Emerson Process Management Regulator Technologies Tulsa, LLC does not assume responsibility for the selection, use or maintenance of any product. Responsibility for proper selection, use and maintenance of any Emerson Process Management Regulator Technologies Tulsa, LLC product remains solely with the purchaser.