

74-2400 Series

Regulators - Pressure Reducing

D74241729X012

Specifications

For other materials or modifications, please consult TESCOM.

OPERATING PARAMETERS

Pressure rating per criteria of ANSI/ASME B31.3

Maximum Inlet Pressure

600 or 3500 psig / 41.4 or 241 bar

Outlet Pressure Ranges

30, 60, or 100 psig / 2.1, 4.1, or 6.9 bar

Design Proof Pressure

150% of maximum rated

Inboard Leak Rate

1×10^{-9} atm cc/sec He

Operating Temperature

PCTFE Seat: -40°F to 140°F / -40°C to 60°C

Vespel® Seat: -40°F to 350°F / -40°C to 177°C

Flow Capacity

$C_v = 0.06$ (3500 psig / 241 bar model)

$C_v = 0.15$ (600 psig / 41.4 bar model)

Decaying Inlet Characteristic

$C_v = 0.06$: 0.7 per 100 psig / 0.05 per 6.9 bar

MEDIA CONTACT MATERIALS

Body

316L VAR Stainless Steel Electropolish

Diaphragm

316L Stainless Steel

Seat

PCTFE (Vespel® Optional for 3500 psig / 241 bar model)

Valve Stem

316 Stainless Steel

Rear Seal

316 Stainless Steel

OTHER

Internal Surface Finish

10 R_a microinch / 0.25 micrometer

Connections

Welded female or male VCR®

Tube stubs

High Purity Internal Connections (H.P.I.C.)

(Internal style of VCR®, compatible with male swivel VCR®)

Cleaning

DI water electronic grade cleaned and ES 500 Particle Certified for internal electropolish models

Internal Volume

2.9 cc

Weight (without gauges)

2.0 lbs / 0.9 kg

Vespel® is a registered trademark of E.I. du Pont de Nemours and Company.
VCR® is a registered trademark of Cajon Co.



TESCOM 74-2400 Series ultra high purity, tied diaphragm pressure reducing regulator provides low internal volume and an internally springless and threadless design. The 74-2400 Series offers a 10 R_a surface finish and 316 Stainless Steel VAR. Inlet pressures are 600 or 3500 psig / 41.3 or 241 bar with outlet pressures up to 100 psig / 6.9 bar.

Applications

- 1/4" point-of-use
- Gas cabinets
- Semiconductor manufacturing
- Valve manifold boxes
- Research labs

Features and Benefits

- Manufactured and tested using Total Quality tools including Statistical Process Control
- No internal springs and a low internal volume minimizes particle entrapment
- Metal-to-metal seal at diaphragm or body interface
- 10 R_a microinch / 0.25 micrometer finish is available

74-2400 Series Regulator Drawing

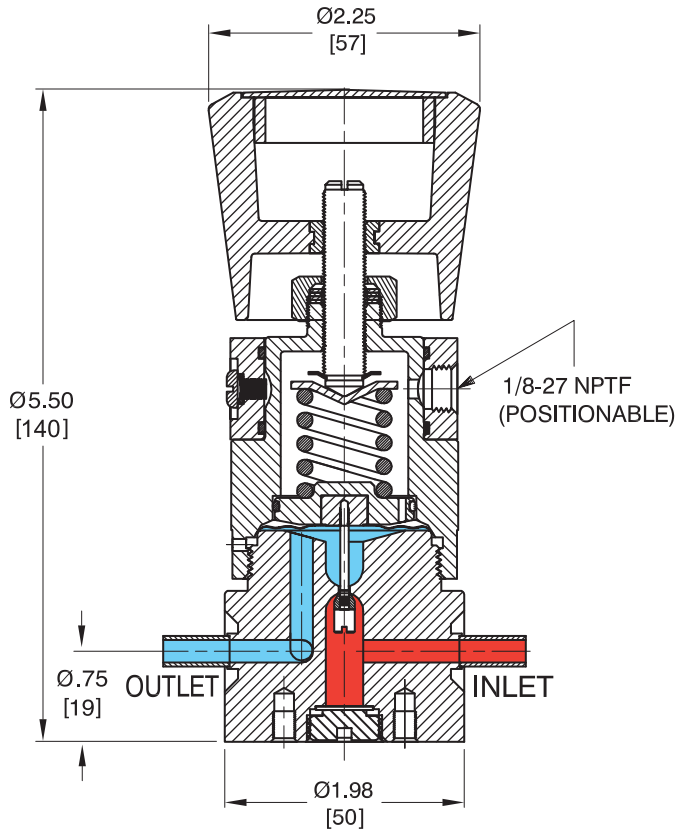

GAUGE PORT OPTIONS

Figure A (no gauges)

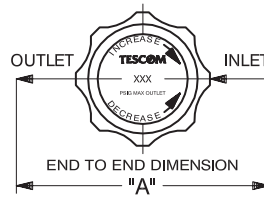

Figure B (2 gauges)

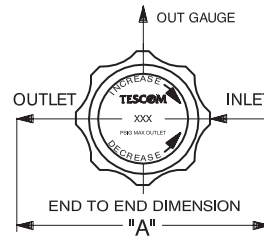
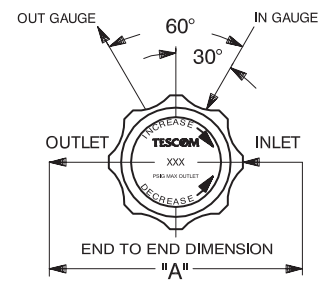

Figure C (1 gauge)

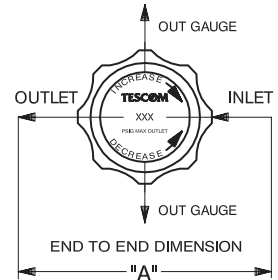
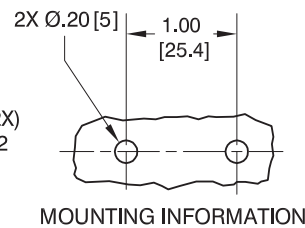
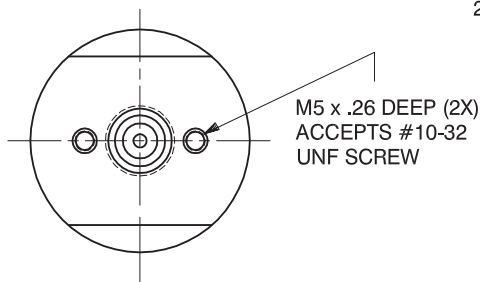

Figure D (2 gauges)



All dimensions are reference & nominal
Metric [millimeter] equivalents are in brackets

74-2400 Series Regulator Flow Chart

For more information on how to read flow curves, please refer to the Flow Curves and Calculations document (debul2007x012) in the TESCOM catalog or on www.tescom.com.

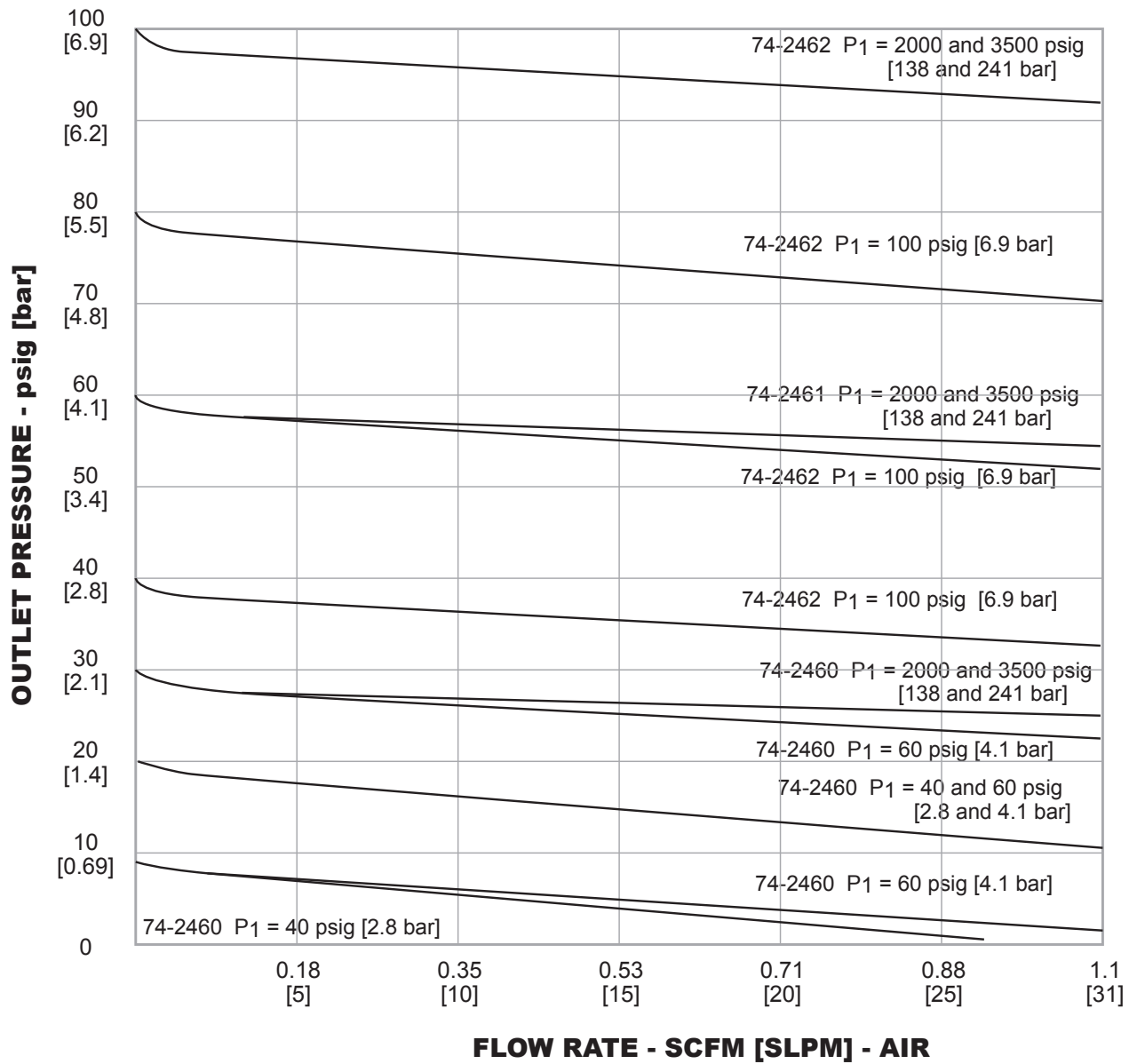

74-2400 Series Regulator Part Number Selector

Repair Kits, Accessories & Modifications may be available for this product. Please contact TESCOM for more information.

Example for selecting a part number:

74-24	6	2	K	A4	1	0		
BASIC SERIES	BODY MATERIAL / FINISH	OUTLET PRESSURE RANGES	SEAT MATERIAL	INLET AND OUTLET PORT SIZE AND TYPE	'A' ± 0.06"	MAXIMUM INLET PRESSURE	GAUGE PORT OPTIONS	NUMBER OF GAUGE PORTS (FIGURE)
74-24	6 – 316L VAR Stainless Steel Electropolish: 10 R _a ¹	0 – 30 psig 2.1 bar 1 – 60 psig 4.1 bar 2 – 100 psig 6.9 bar	K – PCTFE (standard) V – Vespel® (3500 psig / 241 bar model only)	A4 – 1/4" H.P.I.C. RK – 1/2" Male Swivel RL – 1/2" Female Swivel RM – 1/4" Male Swivel RT – 1/4" Female Swivel RU – IN Port: 1/4" Male; OUT Port: 1/4" Female RV – IN Port: 1/4" Female; OUT Port: 1/4" Male T4 – 1/4" Tube Stubs	1.09" 4.75" 4.75" 3.70" 3.70"	1 – 3500 psig 241 bar 2 – 600 psig 41.4 bar	0 – None 1 – 1/4" H.P.I.C. 2 – 1/4" H.P.I.C. 3 – 1/4" H.P.I.C. 4 – 1/4" Male Swivel 5 – 1/4" Male Swivel 6 – 1/4" Male Swivel 7 – 1/4" Female Swivel 8 – 1/4" Female Swivel 9 – 1/4" Female Swivel S – 1/4" Fixed Male T – 1/4" Fixed Male U – 1/4" Fixed Male	0 (Figure A) 1 (Figure C) 2 (Figure B) 2 (Figure D) 1 (Figure C) 2 (Figure B) 2 (Figure D) 2 (Figure D) 1 (Figure C) 2 (Figure B) 2 (Figure B) 1 (Figure C) 2 (Figure B) 1 (Figure C) 2 (Figure B) 2 (Figure D)
	1. Per SEMI F19, UHP grade							



WARNING! Do not attempt to select, install, use or maintain this product until you have read and fully understood the TESCOM Safety, Installation and Operation Precautions.