

Paine 310-38-0050 Series Pressure Transducer

Ultra-Miniature, High Precision, +218 °C, 0-25,000 PSIA (0-1723 BAR)



The 310-38-0050 Series is our ultra-miniature (0.37-in. OD) high precision pressure and temperature transducer designed for extreme downhole high cycle, high pressure 0-25,000 PSIA (0-1723 BAR) and high temperature (+425 °F, +218 °C) applications. Applications requiring accuracy, stability and long term performance.

The 310-38-0050 Series provides critical, real time data that operators expect for faster and more improved decision making in the downhole oil and gas exploration and production environments. Better data for smoother and more efficient operations, increased reliability and the reduction of lost time and equipment.

Solutions

- Ultra-Miniature Diameter: 0.37-in. (0.93cm)
- Pressure & Temperature Measurements
- Harsh/Extreme Environment Ready.
- Excellent Long Term Stability.

Potential Applications

- Downhole Tools (MWD, LWD, Wireline & more).
- Artificial Lift & Subsea Risers.
- Subsea Hydraulic Controls.

Features

- **Total Error Band:** ±0.025% of Full Scale Sensitivity.
- **Output:** mV/V
- **Operating Temperature:** -40 °F to +425 °F (-40 °C to +218 °C).
- **Pressure Range:** 0-5,000 to 0-25,000 PSIA (345 to 1723 BAR).
- **Operating Media:** Any compatible with alloy UNS N07718 solution annealed and age hardened to Rockwell C 40 maximum. Alloy 718.
- **Pressure Fitting:** Per MS33656-E3.

Specifications

Calibration: Calibration Certificates are supplied with each unit and available on-line.

Performance

Full Scale Sensitivity (F.S.S.): 2.6 mV/V nominal at 75 °F (23 °C).

Total Error Band* (Non-Linearity, Hysteresis & Thermal Effects): Shall not be greater than ± 0.025% of the F.S.S. as compared to the serial number specific polynomial model P(T, mV) for all input pressures and temperatures over the calibrated range.

Output at Zero Pressure: 0.1 mV/V ± 0.1 mV/V at 75 °F (23 °C).

Platinum Resistance Temperature Detector (RTD): Pt 1000 Ω ± 0.06% at 32 °F (0 °C), Class A per IEC 751, Alpha = .00385 nominal.

Environmental

Operating Temperature Range: -40 °F to +425 °F (-40 °C to +218 °C).

Calibrated Temperature Range: +75 °F to +350 °F (+23 °C to +176 °C).

Pressure Media: Any compatible with alloy UNS N07718 solution annealed and age hardened to Rockwell C 40 HRC maximum. Alloy 718.

Contents

Specifications..... 2 Dimensional Drawings4

Mechanical

Pressure Range: Contact factory for additional pressure ranges.

Pressure table			
Standard part number	Pressure range PSIA (BAR)	Proof pressure PSIA (BAR)	Burst pressure PSIA (BAR)
310-38-0050-05K0	0-5,000 (0-344)	7,500 (517)	10,000 (689)
310-38-0050-15K0	0-15,000 (0-1034)	18,750 (1292)	22,500 (1551)
310-38-0050-25K0	0-25,000 (0-1723)	30,000 (2068)	35,000 (2413)

Pressure Fitting: Per MS33656-E3 except bore diameter.

Installation Information: Thermal coefficient of the manifold expansion should not exceed 8.33×10^{-6} in./in. °F for operation above 100 °C.

Recommended Installation Torque: 125 to 150 in-lb (14 to 17 N-m).

Electrical

Excitation: 1 to 20 VDC minimum (5 VDC nominal).

Input Resistance: $1200 \pm 300\Omega$.

Output Resistance: $1200 \pm 150\Omega$.

Insulation Resistance: All conductors together to case, 100M Ω minimum at 50 VDC and at +77 °F (25 °C).

Electrical Connections: High temperature solderable connections.

Dimensional Drawings

Figure 1. 212-40-020 Series

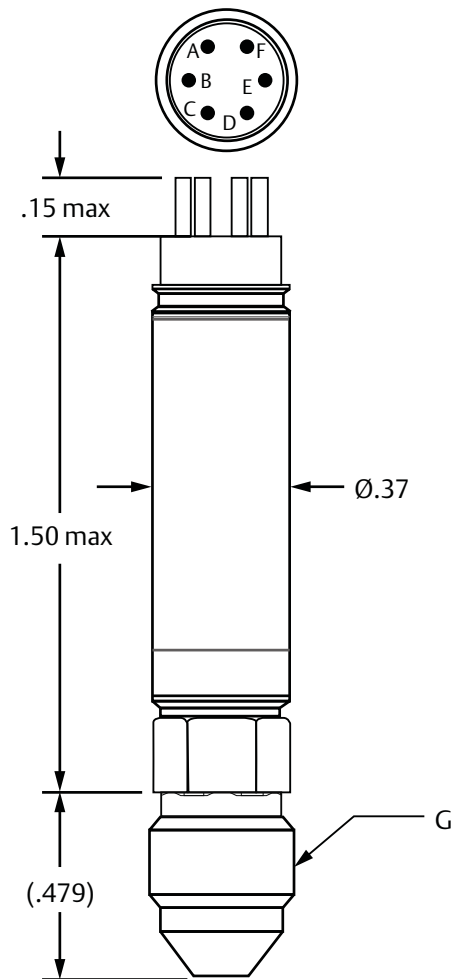

Connections	
PIN	Function
A	+ Excitation
B	+ Signal
C	- Signal
D	- Excitation
E	R.T.D.
F	R.T.D.

G. Fitting end per MS33656-E3 Except Port ID
 Dimensions are inches.

This page is intentionally left blank.

Rosemount Specialty Product LLC

Emerson Process Management

5545 Nelpar Drive
East Wenatchee, WA 98822, USA

 +1 509 881 2100

 +1 509 881 2115

 Paine.Products@Emerson.com

 [Linkedin.com/company/Emerson-Process-Management](https://www.linkedin.com/company/Emerson-Process-Management)

 [Twitter.com/Rosemount_News](https://twitter.com/Rosemount_News)

 [Facebook.com/Rosemount](https://www.facebook.com/Rosemount)

 [Youtube.com/user/RosemountMeasurement](https://www.youtube.com/user/RosemountMeasurement)

 [Google.com/+RosemountMeasurement](https://plus.google.com/+RosemountMeasurement)

Standard Terms and Conditions of Sale can be found at:
[EmersonProcess.com/Rosemount](https://www.EmersonProcess.com/Rosemount)

The Emerson logo is a trademark and service mark of Emerson Electric Co.
The Paine brand and Paine logotype are trademarks of Emerson Electric Co.
All other marks are the property of their respective owners.
© 2016 Emerson Process Management. All rights reserved.