

Product data sheet

Sheet No.: 1.604.02 - Rev: 0 Page 1 of 5

Date: January, 2013

FieldQ

Smart - Control Modules

QC34: FOUNDATION™ fieldbus

Description:

This FieldQ Control Module offers an integrated concept for valve automation. Its compact and robust construction incorporates basic control and feedback functionality and communicates through the FOUNDATION™ fieldbus protocol.

Construction

The Control Module is mounted at the side of the Pneumatic Module in front of the basic actuator housing. Inside are terminals available, for connecting the bus wiring and a button board. Two cable entries are available for this purpose.

Features

- **FOUNDATION™-Fieldbus** digital communication.
- **Supports PlantWeb Alerts.**
- **Supports NAMUR NE-107 Alarms**
- **Supports both single and double acting actuators.**
- **One entry for all wiring** (control and feedback).
- **IPT-technology** (Intelligent Position Tracking).
- **Initialization by FOUNDATION fieldbus or Push-button** for easy setup of the actuator.

Pressing 4 seconds simultaneously the "Open" and "Closed" reassignment buttons starts auto-initialization procedure and sets automatically the feedback limit switches.

- **Adjustable or Reversible position feedback** using the re-assignment buttons or by FOUNDATION fieldbus.

- **Adjustable switch points** can be adjusted from 5% to 30% before the end of the stroke by FOUNDATION fieldbus.

- **Three indication LED's** for "Status", "Open" and "Closed" position. Status LED indicates:

- Initialization procedure running (blinking),
- Successful initialization procedure (LED is on) or
- No or failed initialization (flashing)

- Control Module **can be easily plugged** in the Pneumatic Module.

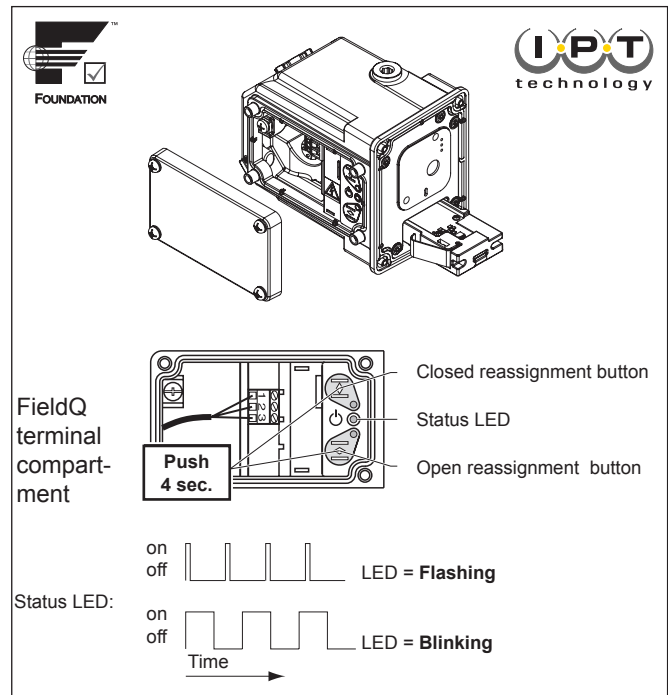

General specifications

Material housing	: Aluminium alloy
Cable entries	: 2x M20x1.5 or 2x 1/2"NPT
Electrical connections	: Internal terminal strip. : Optional quick connectors: 7/8" or M12 connector (see page 2)
Enclosure	: IP65 / NEMA 4X
Finish	: Polyester non-TGIC based powder coating.
Operating media	: Air or inert gasses, filtered at 5 micron.
Temperature	: -20° to +50°C / -4° to 122°F
Dimensions	: See 1.603.01 metric : See 1.603.04 imperial/UNC : See 1.603.02 DIN 3337



www.FieldQ.com

Copyright © Emerson Process Management. The information in this document is subject to change without notice. Updated data sheets can be obtained from our web site www.Fieldq.com or from your nearest Valve Automation Center:

America's: +1 813 630 2255 (fax +1 630 9449) Europe: +31 74 256 10 10 (fax +31 74 291 09 38) Asia/Pacific: +65 626 24 515 (fax +65 626 80 028)



EMERSON™
Process Management

Product data sheet

Sheet No.: 1.604.02 - Rev: 0 Page 2 of 5

Date: January, 2013

FieldQ

Communication Protocol:

Protocol : FOUNDATION™ fieldbus
Transmission : H1, IEC 61158-2
Maximum current : 18mA from bus
Required external protection : Restrict the power supply current to <600mA.

Function blocks

The Control Module provides the following function blocks:

- Resource Block (RB)
- Transducer Block (TB)
- Analog Input (AI) Function Block
- Discrete Output (DO) Function Block
- 2x Discrete Input (DI) Function Block
- PID Function Block

Diagnostics and Alerts

Standard FOUNDATION fieldbus diagnostics and alerts provided meets Emerson PlantWeb Alerts standard.

Applicable diagnostics include:

- Travel times for the Open stroke, Close stroke and Average travel times.
- Cycle Counters for Control Module, Pneumatic Module, Actuator and Valve
- Time in Position
- Various internal electronic health tests.
- Instrument temperature.

For more detailed information on diagnostics see page 3 and 4.

Options:

Manual Control





- Can be added as kit or factory option in 2 versions, "Push button" or a "Push and lock" button.

Glands, plugs and quick connectors

- FieldQ Control Modules can be shipped with plastic or metal glands (M20x1.5 or 1/2"NPT) and rated IP65 or higher or a prewired quick connector.

Hazardous area executions:

Control Module QC34 with FOUNDATION fieldbus is available with optional intrinsically safe (IS) or Non-Incendive/Non Sparking (NI) approvals as listed below:

- **IECEx: Certificate** : KEM 07.0045X
: **Intrinsically safe***
: Ga Ex ia IIC T4
: Ex iaD 20 T80° / IP65
: **Certificate** : KEM 07.0046X
: **Non-Sparking**
: Ex nA II T4
: Ex nL IIC T4
: Ex tD A22 T80°C
- **ATEX: Certificate** : KEMA 02ATEX1242X
: **Intrinsically safe***
:  II 1 G Ex ia IIC T4
:  II 1 D Ex iaD 20 T80° / IP65
: **Certificate** : KEMA 02ATEX1258X
: **Non-Sparking**
:  II 3 G Ex nA II T4
:  II 3 G Ex nL IIC T4
:  II 3 D Ex tD A22 T80°C
- **FM** : **Intrinsically safe**, Class I, II, III Div.1,
Groups ABCDEFG, T4, Type4X/IP65
: Class I, Zone 0, AEx ia IIC T4
: **Non Incendive**, Class I, II, III, Division 2,
: Groups ABCDFG, T4, Type 4X/IP65
: Class I, Zone 2, IIC T4, Type 4X/IP65
- **CSA** : **Certificate**: 1477696
: **Intrinsically safe**, Class I, II, III Div.1,
Groups ABCDEFG, T4
: Ex ia IIC T4, IP65, (Class I, Zone 0/1)
: **Non Incendive**: Class I, II, III Div.2,
Groups ABCDFG, T4
: Ex nA II T4 (Class I, Zone 2)
: Ex nL II T4 (Class I, Zone 2)

Ambient temperature:

T4 @ Ta = : -20°C...+50°C IP65

Note:

- * The assembly of a FieldQ Actuator with the intrinsically safe QC34 Control Module, may be used in (ATEX) classified Zones 1, 2 (Gasses) and/or 21, 22 (Dust).

FISCO & FNICO systems

The FieldQ QC34 is suitable for use in a FISCO or FNICO system in accordance with IEC 60079-27 :2005



www.FieldQ.com

Copyright © Emerson Process Management. The information in this document is subject to change without notice. Updated data sheets can be obtained from our web site www.Fieldq.com or from your nearest Valve Automation Center:

America's: +1 813 630 2255 (fax +1 630 9449) Europe: +31 74 256 10 10 (fax +31 74 291 09 38) Asia/Pacific: +65 626 24 515 (fax +65 626 80 028)



EMERSON™
Process Management

Product data sheet

Sheet No.: 1.604.02 - Rev: 0 Page 3 of 5

Date: January, 2013

FieldQ

FOUNDATION™ fieldbus terminal wiring

Standard PI-filter present.

Detailed Intrinsically safe or Non-Incendive/Non-Sparking wiring instructions, will be shipped with the product, see Installation Guide : DOC.IG.QC34.1

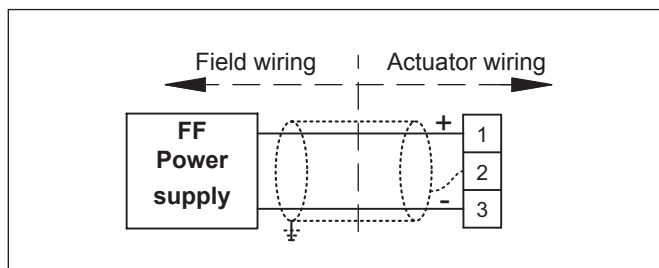

Quick connector pinouts:

(male chassis part)

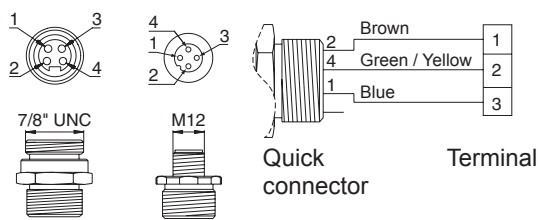

Wiring dimensions

Solid wire : 2.5mm² max.

Stranded wire : 0.2-3.3mm² or 24-12 AWG

Quick connector pinouts:

- The FOUNDATION fieldbus Module can optionally be equipped with prewired quick connectors. Two versions are available: 7/8" or M12 (male chassis part).
- Quick connectors, as shown below are excluded for non-Incendive or non-sparking use in hazardous area's classified as Zone 2 or 22 or CI I, II, III, Div. 2.

Diagnostics and PlantWeb Alerts QC34 FOUNDATION fieldbus

The FieldQ Control Module with FOUNDATION fieldbus communication has diagnostic capabilities. These process parameters can give information about communication condition, valve and/or actuator unit. It enables to predict failures in advance and makes maintenance easier to schedule. The following diagnostics are available for the FieldQ:

1 Timer parameters:

1. Open and Closed travel time
2. High and low limits of Open and Closed travel time
3. Average travel times of last 30 strokes of Open and Closed travel.
4. High and low limits of average Open and Closed travel time

2 Cycle Counters

1. Control Module - Counts how many times the Control Module cycles (read only).
2. Pneumatic Module - Counts how many times the Pneumatic Module cycles.
3. Actuator - Counts how many times the actuator cycles.
4. Valve - Counts how many times the valve cycles.

3 Time In Position

4 Various internal electronic health tests.

PlantWeb Alerts

PlantWeb Alerts are alerts that have been predefined and categorized for the user. These device alerts can be used to help troubleshoot the instrument (see also page 4). There are three categories:

- **Failed alerts,**
A failed alert indicates a failure within the device that will make the device, or some part of the device, non-operational.
- **Maintenance alerts**
A maintenance alert indicates that the device, or some part of the device, needs maintenance soon.
- **Advisory alerts**
An advisory alert indicates a condition that does not have a direct impact on the device's primary function. If the condition is ignored, the device will eventually fail.

These alerts, when enabled, can participate in the DeltaV alarm interface tools such as the alarm banner, alarm list, and alarm summary.



www.FieldQ.com

Copyright © Emerson Process Management. The information in this document is subject to change without notice. Updated data sheets can be obtained from our web site www.Fieldq.com or from your nearest Valve Automation Center:

America's: +1 813 630 2255 (fax +1 630 9449) Europe: +31 74 256 10 10 (fax +31 74 291 09 38) Asia/Pacific: +65 626 24 515 (fax +65 626 80 028)



EMERSON™
Process Management

Product data sheet

Sheet No.: 1.604.02 - Rev: 0 Page 4 of 5

Date: January, 2013

FieldQ

Diagnostics and PlantWeb Alerts

Alerts & recommended actions			Alert default setting					
			Advisory		Maintenance		Fail	
Alerts	Recommended actions	enable	mask *	enable	mask *	enable	mask *	
bit 0	Reserved							
bit 1	Internal alerts, bad position sensor	Feedback problem, replace control module when possible	n	n	y	y	n	n
bit 2	Internal alerts, bad temperature sensor	Temperature sensor problem, replace Control Module when possible	n	n	y	y	n	n
bit 3	Internal alerts, Specified system temperature exceeded	Take corrective actions to bring temperature within specified range.	n	n	y	y	n	n
bit 4	Internal alerts, Software error		n	n	y	n	n	n
bit 5	Internal alert, travel deviation	Lost position, Check air pressure	y	y	n	n	n	n
bit 6	Internal alerts, Shutdown is set	Internal communications problem, check shutdown configuration for restart, Replace Control Module.	n	n	n	n	y	y
bit 7	Internal alerts, Undefined error		n	n	y	n	n	n
bit 8	Counter alerts, Control Module life cycle exceeded	Control Module life cycle exceeded, Replace Control Module	n	n	y	y	n	n
bit 9	Counter alerts, Pneumatic Module life cycle exceeded	Pneumatic Module life cycle exceeded, Replace Pneumatic Module.	n	n	n	n	n	n
bit 10	Counter alerts, Actuator life cycle exceeded	Actuator life cycle exceeded, Replace actuator.	n	n	n	n	n	n
bit 11	Counter alerts, Valve life cycle exceeded	Valve life cycle exceeded, take Valve requires maintenance.	n	n	n	n	n	n
bit 12	Timer alerts: time in position limit	Time in position exceeded, appropriate action.	n	n	n	n	n	n
bit 13	Timer alerts: open travel time limit exceeded	Open travel timer exceeded, check valve system.	n	n	n	n	n	n
bit 14	Timer alerts: close travel time limit exceeded	Close travel timer exceeded, check valve system.	n	n	n	n	n	n
bit 15	Initialization Failed (reason from AUTO_INITIALIZATION STATUS)	Check air pressure, check actuator sizing, check valve system.	y	y	n	n	n	n
bit 16	Reserved Primary Value Failure							
bit 18	Reserved HW/SW Incompatibility		n	n	n	n	n	n
bit 19	Reserved IO Failure (FF card lost IO board)	Internal communications are lost, device will act according to shutdown configuration.	y	y	n	n	n	n
bit 20	Reserved Mechanical Failure							
bit 21	Reserved TB NV Memory Failure							
bit 22	Reserved RB NV Memory Failure		y	y	n	n	n	n
bit 23	Reserved TB Electronics Failure		y	n	n	n	n	n
bit 24	Reserved RB Electronics Failure		y	y	n	n	n	n

*) Mask "n" indicates masked out (not visible).

For more detailed information about the configuration of the QC34 FOUNDATION™ fieldbus Module see Reference Manual DOC.RM.QC34.E. This manual is available for download from www.FieldQ.com.



www.FieldQ.com

Copyright © Emerson Process Management. The information in this document is subject to change without notice. Updated data sheets can be obtained from our web site www.Fieldq.com or from your nearest Valve Automation Center:

America's: +1 813 630 2255 (fax +1 630 9449) Europe: +31 74 256 10 10 (fax +31 74 291 09 38) Asia/Pacific: +65 626 24 515 (fax +65 626 80 028)



EMERSON™
Process Management

Product data sheet

Sheet No.: 1.604.02 - Rev: 0 Page 5 of 5

Date: January, 2013

FieldQ

Namur NE-107 Alarms

This section describes the parameter interaction to implement a FieldQ™ QC34 Control module to the NAMUR NE-107 requirements as a parameter group in the Resource Block. There are four alarm categories defined as per the NE-107 specification, Failed, Off Specification, Maintenance, and Check function.

Maintenance Although the output signal is valid, the wear reserve is nearly exhausted or a functions will soon be restricted due to operational conditions e.g. build-up of deposits

Off Specification Off-spec means that the device is operating outside its specified range or an internal diagnostic indicates deviations from measured or set values due to internal problems in the device or process characteristics (e.g. bubble formation in flow metering or valve sticking).

Check Function Output signal temporarily invalid (e.g. frozen) due to on-going work on the device.

Failed Output signal invalid due to malfunction in the field device or its peripherals.

Each of these categories share 32 conditions that can be defined by the device manufacturer. Each condition may be mapped or not mapped for each category. If a condition is mapped then it is indicated in the *ACTIVE parameter. If the condition in the *ACTIVE parameter is not masked by the corresponding bit in the *_MASK parameter then the condition will be queued for broadcast using the corresponding *_ALM parameter at the associated priority indicated by *_PRI parameter. The 4 categories are defined below.

The conditions are not expected to identify explicitly the root cause of the condition, but rather to identify it in terms of:

- Replace the device
- Replace a part of the device
- Correct a configuration problem
- Fix something outside of the device

The above list is all that the operator needs to know to restore his process functionality and if there are more than 31 device conditions they should be grouped by definition into these bit

Parameter Mnemonic	Obj Type	Data Type/ Structure	Use/Model	Store	Size	Valid Range	Initial Value	Permission	Other	Range Check
FD_CHECK_ACTIVE	S	Bit String	C/FD Active	D	4				Read only	
FD_CHECK_ALM	R	DS-87	C/Alarm	D	15					
FD_CHECK_MAP	S	Bit String	C/Contained	S	4			ALARM		
FD_CHECK_MASK	S	Bit String	C/Contained	S	4			ALARM		
FD_CHECK_PRI	S	Unsigned8	C/Alert Priority	S	1	0 - 15	0	ALARM		Yes
FD_EXTENDED_ACTIVE_n	S	Bit String	C/Contained	D	4				Read only	
FD_EXTENDED_MAP_n	S	Bit String	C/Contained	S	4					
FD_FAIL_ACTIVE	S	Bit String	C/FD Active	D	4				Read only	
FD_FAIL_ALM	R	DS-87	C/Alarm	D	15					
FD_FAIL_MAP	S	Bit String	C/Contained	S	4			ALARM		
FD_FAIL_MASK	S	Bit String	C/Contained	S	4			ALARM		
FD_FAIL_PRI	S	Unsigned8	C/Alert Priority	S	1	0 - 15	0	ALARM		Yes
FD_MAINT_ACTIVE	S	Bit String	C/FD Active	D	4				Read only	
FD_MAINT_ALM	R	DS-87	C/Alarm	D	15					
FD_MAINT_MAP	S	Bit String	C/Contained	S	4			ALARM		
FD_MAINT_MASK	S	Bit String	C/Contained	S	4			ALARM		
FD_MAINT_PRI	S	Unsigned8	C/Alert Priority	S	1	0 - 15	0	ALARM		Yes
FD_OFFSPEC_ACTIVE	S	Bit String	C/FD Active	D	4				Read only	
FD_OFFSPEC_ALM	R	DS-87	C/Alarm	D	15					
FD_OFFSPEC_MAP	S	Bit String	C/Contained	S	4			ALARM		
FD_OFFSPEC_MASK	S	Bit String	C/Contained	S	4			ALARM		
FD_OFFSPEC_PRI	S	Unsigned8	C/Alert Priority	S	1	0 - 15	0	ALARM		Yes
FD_RECOMMEN_ACT	S	Unsigned16	C/Contained	D	2	1 – manf spec	0		Read only	
FD_SIMULATE	R	DS-89	C/FD Simulate	D	9		disabled			
FD_VER	S	Unsigned16	C/Contained	S	2				Read only	



www.FieldQ.com

Copyright © Emerson Process Management. The information in this document is subject to change without notice. Updated data sheets can be obtained from our web site www.Fieldq.com or from your nearest Valve Automation Center:

America's: +1 813 630 2255 (fax +1 630 9449) Europe: +31 74 256 10 10 (fax +31 74 291 09 38) Asia/Pacific: +65 626 24 515 (fax +65 626 80 028)



EMERSON™
Process Management