

AMS Suite: Global Performance Advisor

- Achieve and maintain optimum equipment performance
- Track key performance indicators in real-time against target operation
- Quantify thermodynamic efficiency losses
- Prioritize and plan maintenance activities
- Determine the root cause of production inefficiencies

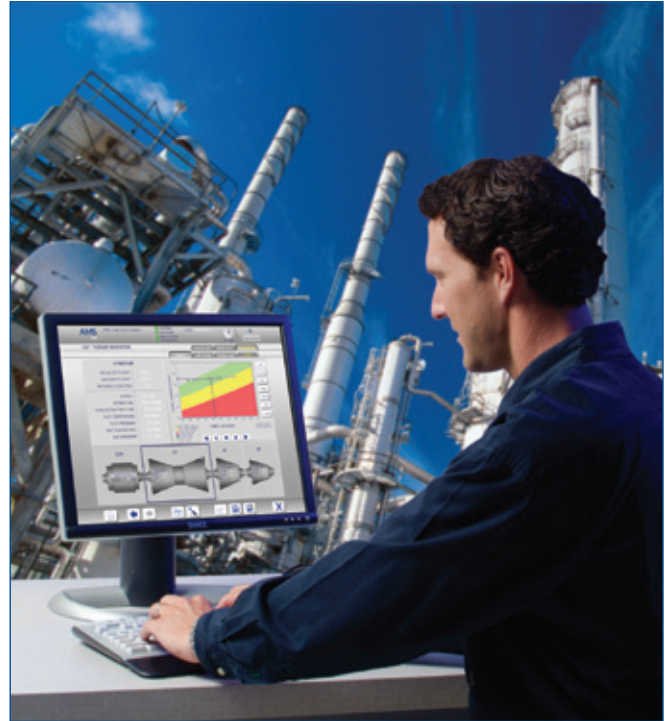

Real-time equipment performance health feedback integrates with process automation so you can run your plant with confidence.

Overview

The performance of all critical equipment will deteriorate over time, resulting in lost performance, increased energy usage, and reduced throughput. Identification of the deviation from equipment design, combined with early detection, is vital to your plant's profitability. Knowing the health and performance of your mechanical equipment allows you to be proactive with your maintenance planning instead of reacting to unexpected events.

AMS Performance Advisor allows you to run your process more efficiently, track operating performance against targets, schedule maintenance activities, and determine the root cause of production asset inefficiencies. When your maintenance and operations staff are alerted to degrading asset performance, critical production decisions can be made to eliminate outages and improve your bottom line.

Achieve and Maintain Optimum Equipment Performance

AMS Performance Advisor calculates thermodynamic-based equipment performance using industry-standard ASME PTC performance calculation techniques to provide deviation from design diagnostics on your critical machinery, including turbines, compressors, boilers, and other production assets.

Specific key performance indicators combined with clear graphical operating plots show exactly where the equipment is currently operating versus expected or design condition.

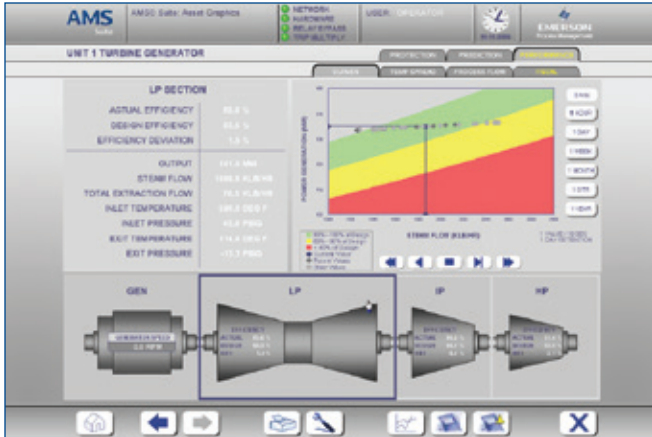

Intuitive user interface reveals clear green-yellow-red operational zones combined with critical protection and prediction information.

Tuning over the first twelve months is included with AMS Performance Advisor and executed by thermodynamic experts to ensure system feedback is credible.

Combining performance data with protection and prediction diagnostics helps your reliability program shift from reactive to planned.

AMS Performance Advisor provides calculated information for the following key equipment types:

- Compressor – Centrifugal
- Compressor – Reciprocating
- Gas Turbine
- Steam Turbine
- Boiler
- Fired Heater / Furnace
- HRSG
- Condenser – Air Cooled
- Condenser – Water Cooled
- Large Fan
- Large Pump
- Cooling Tower

Benefits for the Entire Facility

- **Operators** receive real-time feedback of equipment performance to influence control changes and help meet operational targets.
- **Maintenance** experts can access in-depth diagnostics to understand degradation trends and status by correlating condition and performance data.
- **Process Engineers** can identify potential instrument problems, pinpoint degradation sources, and evaluate the effectiveness of cost improvement actions.
- **Management** understands financial impact of performance deviations.

Integrated Solution

AMS Performance Advisor is part of a seamless integrated solution approach that combines monitoring capabilities for key production assets:

- Protection
- Prediction
- Performance
- Process automation

This solution monitors mechanical assets for temperature, vibration, and efficiency deviations that, if not acted upon, often result in an unplanned shutdown.

Real-Time Equipment Performance Monitoring

The real-time information available from AMS Performance Advisor helps you pinpoint opportunities for performance improvement that would otherwise go unnoticed. Differentiating features add value and knowledge to equipment operation.

- Data connectivity to any historian or DCS regardless of vendor
- Intuitive graphical presentation clearly displays current operating point compared to design criteria
- Integration of protection, prediction, and performance information
- Quarterly tuning of system through first year to ensure credible feedback

Flexible Data Connectivity

AMS Performance Advisor receives measurement input data from existing field instrumentation or from manually-entered values. Data can be connected to any manufacturer's DCS or data historian. This flexibility means that plants with multiple sources of input data and information systems can unify their performance calculations in a single, centralized location.

Leverages Open Protocols

Data connectivity methods are based around industry-standard OPC or OLE (Object Linking and Embedding) for process control. Popular plant historians, such as OSI® PI® are also supported.

Availability of Data Values

AMS Performance Advisor can support data that is entered several times per shift rather than continuously measured. The manual data is submitted directly into the DCS or historian where AMS Performance Advisor will access it using the same method as the continuously measured values.

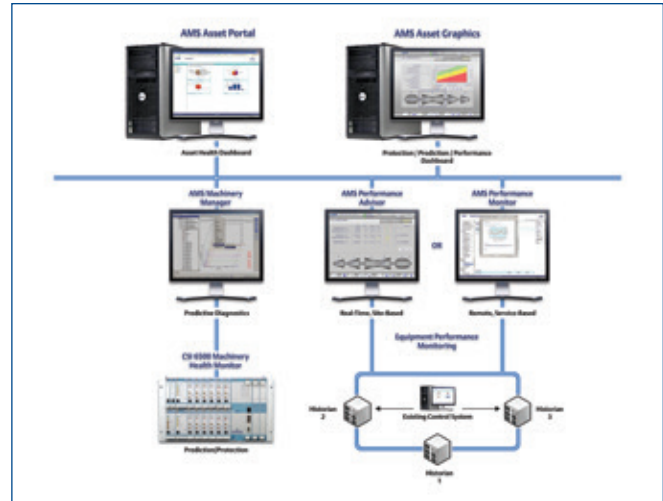

AMS Performance Advisor receives input data from any plant historian via industry-standard OPC protocol.

Intuitive User Interface

Graphical displays can provide key information to guide decisions towards managing "controllable losses" by operating towards optimal targets.

AMS Suite: Asset Graphics presents a graphical interface for protection, prediction, and performance diagnostics utilizing the latest approaches for information clarity:

- Gray screen backgrounds
- Color only when abnormal
- Touch-screen navigation
- Single-equipment layer
- Status safeguards

Single Equipment Layer

All equipment information is available one level deep from the home navigation page. A tab for performance reveals all relevant information.

Multiple Users

AMS Performance Advisor communicates specific diagnostics aligned to plant roles.

- Operators obtain feedback on set point changes with plots that utilize colored regions.
- Maintenance resources can prioritize planned activities.
- Process Engineers can visually isolate poor measurements in the process flow and their influence on the module calculations.

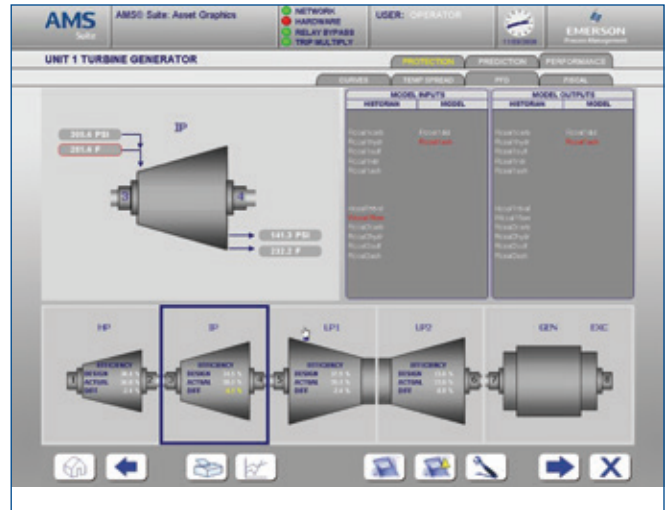

The Process Flow tab provides an easy way to correlate input measurements to the equipment module and determine the impact on model results.

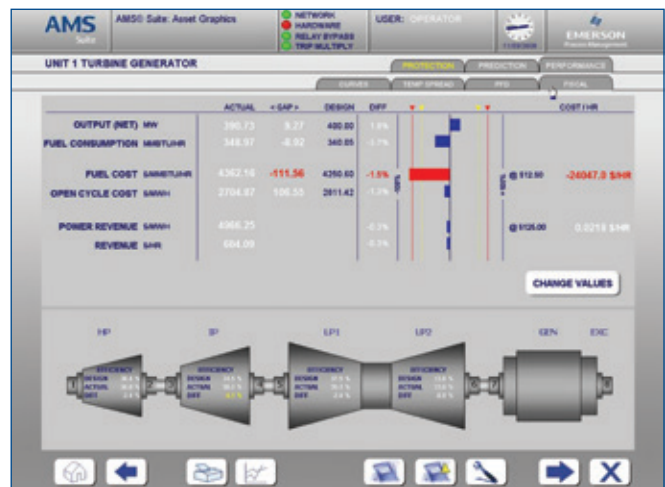

The Fiscal tab shows current financial cost deviation. Trends can reveal accumulated costs and benefits for managing controllable losses.

Part of AMS Suite

AMS Performance Advisor is a key component in AMS Suite, an industry-leading family of predictive maintenance applications.

AMS Suite brings together predictive diagnostics from production and automation assets to help your facility meet business targets.

AMS Suite: Asset Graphics

AMS Performance Advisor presents diagnostic information through AMS Asset Graphics. The graphical user interface uses standard OPC data communication to provide a common interface for the sources of monitored content. AMS Asset Graphics also stores historical trend data.

AMS Suite: Asset Performance Management

AMS Suite APM provides a comprehensive view of the health and performance of the production assets. With AMS Suite APM, you can identify and prioritize the risks to your production.

AMS Suite: Equipment Performance Monitor

Remote analysis of equipment performance data in AMS Performance Advisor is available using the export feature to AMS Performance Monitor. Detailed remote analysis is an optional service contract offering. This capability provides ongoing thermodynamic analysis expertise for AMS Performance Advisor.

Credible System Feedback

AMS Performance Advisor is configured by thermodynamic experts and includes features that are designed to handle common challenges to credible system feedback. Key features include data validation and manipulation, accuracy of results, and analog input filtering.

Input Data Validation

AMS Performance Advisor evaluates the quality of DCS/historian input signals and uses them to provide status, augment data, and issue alerts or warnings.

Since equipment performance calculations are measured to tenths of a percent, module input measurements must be accurate. AMS Performance Advisor ensures the accuracy of these calculations and delivers reliable results.

Analog Input Filtering

AMS Performance Advisor evaluates the quality of DCS/historian input signals and uses them to provide status, augment data, and issue alerts or warnings.

Fidelity of AMS Performance Advisor is ensured through built-in analog input filtering and validation techniques. Analog signals may have a small degree of smoothing applied inside AMS Performance Advisor to improve performance analysis, particularly when noisy data is present.

A reported “poor” or “suspect” status of any input or substituted value is made visible through AMS Asset Graphics in the Process Flow tab, delivering an early warning mechanism for problematic data connectivity or measurement devices.

Configurations and Results That You Can Trust

While spreadsheet applications have been used in the past for equipment performance calculations, they have proven to be cumbersome and inaccurate. AMS Performance Advisor accommodates real-life complexities while providing credible results that you can trust.

Compared to do-it-yourself spreadsheets, AMS Performance Advisor provides overwhelming benefits.

- Easier comparison of reference operation at "standard conditions"
- Easy data cleaning and validation techniques
- Seasonal effects that are easily identified
- Model data smoothing to help you understand underlying performance trends
- Easy-to-use detailed graphical interface and historian capabilities that interface with external data sources
- Consistent model approach for similar units on a site-wide and organization-wide basis

Module: Compressor – Centrifugal

Module Process Flow Diagram

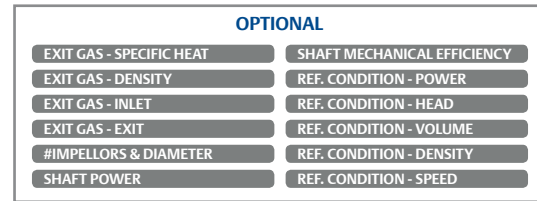
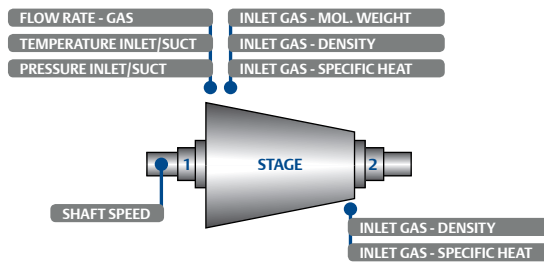

Typical single stage shown.

Equipment Design Information

- Piping & Instrumentation Diagrams (P&ID)
- OEM Design / Equipment Specification Sheets
- Operating Curves* – Head Versus Flow, Efficiency Versus Flow, Discharge Pressure Versus Flow**, Power Versus Flow**

Module Inputs

- Flow Rate – Gas (measured inside any recycle loops)
- Temperature – Inlet / Suction
- Temperature – Exit / Discharge
- Pressure – Inlet / Suction
- Pressure – Exit / Discharge
- Shaft Speed (On Variable Speed Machines)
- Inlet Gas – Molecular Weight
- Inlet Gas – Density (or Inlet Compressibility)
- Inlet Gas – Specific Heat (or Ratio of Specific Heats)

Optional Inputs If Available

- Exit Gas – Specific Heat
- Exit Gas – Density (or Compressibility)
- Pipe Area – Inlet
- Pipe Area – Exit
- Impellor Diameter for Each Impellor
- Number of Impellers
- Shaft Power
- Shaft Mechanical Efficiency
- Reference Condition – Power
- Reference Condition – Head
- Reference Condition – Volume
- Reference Condition – Density
- Reference Condition – Speed

* At various operational speeds

** Optional

Module Calculation Method

- AMSE PTC 10

Module Outputs

- AMSE PTC 10
- Polytropic Efficiency – Actual
- Polytropic Efficiency – Design
- Polytropic Efficiency – Deviation
- Polytropic Head – Actual
- Polytropic Head – Design
- Polytropic Head – Deviation
- Flow Rate – Volumetric Flow Actual
- Flow Rate – Mass Flow
- Shaft Power Consumption (if not measured)
- Deviation Cost (Lost Throughput or Additional Power)

Optional Inputs If Available

- Efficiency and Head – Adiabatic and Isothermal
- Power – Design
- Power – Deviation
- Compressor Gas Velocities – Inlet and Exit
- Flow Rate – Mass Design and Deviation
- Suction Stagnation Conditions
- Discharge Stagnation Conditions
- Temperature – Theoretical Rise and Ratio
- Temperature – Actual Rise and Ratio
- Pressure – Rise and Ratio
- Corrected & Normalized – Volume Flow, Head and Power
- Machine Work Coefficients & Machine Mach Number

NOTE: A turbo-compressor is a turbine module + compressor module

Module: Compressor – Reciprocating

Module Process Flow Diagram

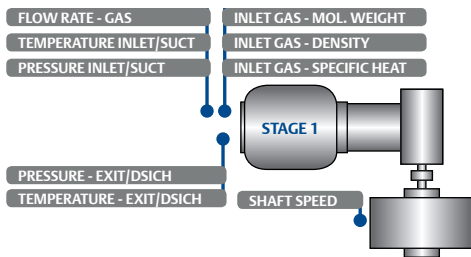

OPTIONAL

EXIT GAS - SPECIFIC HEAT	SHAFT MECHANICAL EFFICIENCY
EXIT GAS - DENSITY	REF. CONDITION - POWER
EXIT GAS - INLET	REF. CONDITION - HEAD
EXIT GAS - EXIT	REF. CONDITION - VOLUME
#IMPELLORS & DIAMETER	REF. CONDITION - DENSITY
SHAFT POWER	REF. CONDITION - SPEED

Typical single stage shown.

Equipment Design Information

- Piping & Instrumentation Diagrams (P&ID)
- OEM Design / Equipment Specification Sheets; Including
 - Single/Double Acting, Stroke Length, Bore, Piston Area, Con-Rod Area
- Operating Curves (Required): Power Versus Flow

Module Inputs

- Flow Rate – Gas (measured inside any recycle loops)
- Temperature – Inlet / Suction
- Temperature – Exit / Discharge
- Pressure – Inlet / Suction
- Pressure – Exit / Discharge
- Shaft Speed
- Inlet Gas – Molecular Weight
- Inlet Gas – Density (or Inlet Compressibility)
- Inlet Gas – Specific Heat (or Ratio of Specific Heats)

Optional Inputs If Available

- Shaft Power
- Discharge Gas – Density
- Discharge Gas – Specific Heat
- Temperature – Cooling Jacketed Coolant Inlet
- Temperature – Cooling Jacket Coolant Exit
- Clearance Operation
- Rod Drop Measurement
- Pipe Area – Inlet
- Pipe Area – Exit

Module Calculation Method

- ASME PTC 9

Module Outputs

- Swept Volume
- Clearance – Volume and Percent
- Volumetric Efficiency – Actual
- Volumetric Efficiency – Design
- Volumetric Efficiency – Deviation
- Polytropic Efficiency – Actual
- Polytropic Efficiency – Design
- Polytropic Efficiency – Deviation
- Polytropic Head – Actual
- Power – Design
- Power – Deviation from Design Power
- Flow Rate – Actual Volumetric and Mass
- Power – Specific per Mass Flow
- Flow Rate – Design and Deviation from Design Mass Flow
- Deviation Cost (Lost Throughput or Additional Power)

Additional Available Outputs

- Efficiency and Head – Adiabatic and Isothermal
- Power – Shaft
- Compressor Gas Velocities – Inlet and Exit
- Shaft Efficiency
- Suction Stagnation Conditions
- Discharge Stagnation Conditions
- Temperature – Theoretical Rise and Ratio (with and without cooling duty)
- Temperature – Actual Rise and Ratio
- Pressure – Rise and Ratio
- Rod-load

Module: Gas Turbine

Module Process Flow Diagram

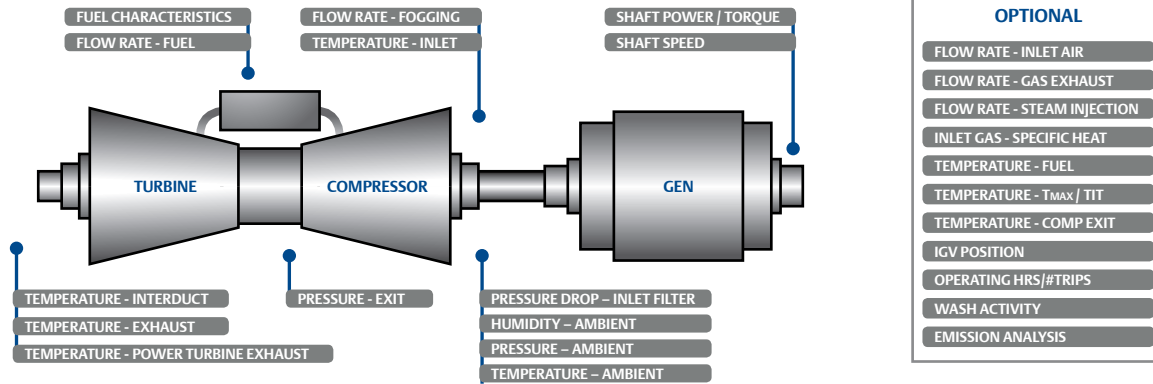

Equipment Design Information

- Piping & Instrumentation Diagrams (P&ID)
- OEM Design / Equipment Specification Sheets and Correction Curves to ISO Conditions
- GT Load Testing – Acceptance Testing Data; Design at Various Gas Turbine Loads (50%, 75%, 100% load)

Module Inputs

- Flow Rate – Fuel
- Flow Rate – Fogging / Evaporative Cooling
- Flow Rate – Steam Injection (where appropriate)
- Temperature – Ambient
- Temperature – Compressor Inlet
- Temperature – Interduct and/or Exhaust
- Temperature – Power Turbine Exhaust (as appropriate)
- Pressure – Ambient
- Pressure – Compressor Exit
- Pressure Drop – Inlet Filter
- Humidity – Ambient
- Shaft Speed(s)
- Shaft Power / Torque (MW, MVAR, etc)
- Fuel Characteristics (LHV, Composition)

Optional Inputs If Available

- Flow Rate – Inlet Air and Gas Exhaust
- Temperature – Fuel
- Temperature – Tmax or TIT or Turbine First Blade
- Temperature – Compressor Exit(s)
- IGV Position
- Operating Hours / No. Trips / No. Starts
- Wash Activity / Inlet Heating Activity
- Emissions Analyses (e.g. NOx / SOx / COx)

Module Calculation Method

- ASME PTC 22 – Corrected output, heat rate, and thermal efficiency are calculated based on correction curves provided by the turbine manufacturer. Design combustion turbine heat rate and efficiency are calculated based on turbine design data and compared to the corrected values.

Module Outputs

- Thermal Efficiency – Actual
- Thermal Efficiency – Design (Baseline)
- Thermal Efficiency – Deviation
- Thermal Efficiency – Corrected
- Heat Rate – Actual
- Heat Rate – Design
- Heat Rate – Deviation
- Heat Rate – Corrected
- Power Output – Actual
- Power Output – Design (Baseline)
- Power Output – Deviation
- Power Output – Corrected
- Deviation Cost (Increased Fuel or Reduced Power)

Additional Available Outputs

- Compressor Efficiency – Polytropic
- Compressor Temperature Ratio
- Compressor Pressure Ratio
- Temperature – Exhaust Spread
- Temperature Profile
- Temperature Profile – Exhaust Deviation

NOTE: A turbo-compressor is a turbine module + compressor module

Module: Steam Turbine

Module Process Flow Diagram (example HP / IP / LP shown)

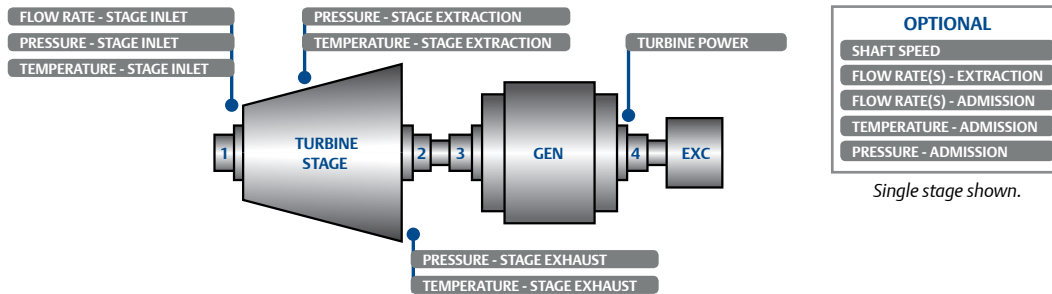

Equipment Design Information

- Piping & Instrumentation Diagrams (P&ID)
- OEM Design / Equipment Specification Sheets
- OEM Heatload Diagrams as Various Outputs
- Operating Curves: Efficiency Versus Steam Flow, Efficiency Versus Power Curves

Module Calculation Method

- ASME PTC 6 – This method utilizes enthalpy drop approach.

Module Inputs

- Flow Rate(s) – Stage Inlet
- Temperature(s) – Stage Inlet
- Temperature(s) – Stage Extraction
- Temperature – Stage Exhaust
- Pressure(s) – Stage Inlet
- Pressure(s) – Stage Extraction
- Pressure – Stage Exhaust
- Turbine Power (MW, Torque, or similar)

Module Outputs

- Thermal Efficiency – Actual (per stage and overall)
- Thermal Efficiency – Design (per stage and overall)
- Thermal Efficiency – Deviation (per stage and overall)
- Power – Actual (per stage and overall)
- Power – Design (per stage and overall)
- Power – Deviation (per stage and overall)
- Steam Rate (per stage and overall)
- Deviation Cost (Increased Steam Consumption or Reduced Power)

Optional Inputs If Available

- Speed
- Flow Rate(s) – Extraction
- Steam Flow(s) – Admission
- Steam Temperature – Admission
- Steam Pressure – Admission
- Feedwater flow/temperature(s) for extraction estimation

Additional Available Outputs

- Flow Rate(s) – Turbine Section Extraction Steam
- Estimated Exhaust Quality
- Expected Design Temperature(s)
- Operating Temperature Ratios
- Operating Pressure Ratio

Module: Boiler

Module Process Flow Diagram

- See Boiler Figure

Equipment Design Information

- Piping & Instrumentation Diagrams (P&ID)
- OEM Design / Equipment Specification Sheets
- Rated Cases: (50%, 70%, 80%, 90%, 100% load)
- Boiler efficiency is calculated using the ASME PTC

Module Inputs

- Fuel – Feed Composition and Heating Values
- Flow Rate(s) – Fuel
- Flow Rate – Reheat Steam (as appropriate)
- Flow Rate – Steam and/or Feed Water
- Flow Rate(s) – De-Superheater Spray Water
- Flow Rate(s) – Reheat De-Superheater Spray Water
- Temperature – Air Inlet
- Temperature – Feed Water
- Temperature – Stack Gas
- Temperature – Steam Exit
- Temperature(s) – De-Superheater Spray Water
- Temperature – Reheat In and Exit (as appropriate)
- Temperature – Reheat De-Superheater Spray Water (as appropriate)
- Pressure – Reheat In and Exit (as appropriate)
- Analysis – Flue Gas Combustion O₂

Optional Inputs If Available

- Flow Rate(s) – Feed Air
- Flow Rate(s) – Soot Blowing Steam
- Flow Rate – Blowdown
- Temperature – Fuel Feed
- Temperature – Furnace Firing
- Temperature – Combustion Air
- Temperature(s) – Flue Along Gas Path
- Temperature(s) – Economizer Exit Water
- Temperature(s) – De-Superheater Steam Inlet/Exit
- Pressure – Boiler Feed Water
- Pressure – Steam Drum
- Pressure(s) – Intermediate Steam Superheater
- Analysis – Stack Excess O₂
- Analysis – Flue Gas (e.g. NO_x / SO_x / CO_x / H₂O)

Module Calculation Method

- ASME PTC 4.1 (heat loss method) – For a regenerative or tubular type air heater, the module computes corrected gas outlet temperature and air heater gas-side efficiency in accordance with ASME PTC 4.3. Design gas-side efficiency is calculated and compared to the actual efficiency. For tri-sector type air heaters, air and gas-side efficiencies are calculated and compared to design values.

Module Outputs

- Efficiency – Actual (Heat Loss and Input / Output)
- Efficiency – Design (Baseline)
- Efficiency – Deviation
- Flow Rate – Steam Actual
- Flow Rate – Steam Design (Baseline)
- Flow Rate – Steam Deviation
- Combustion O₂ – Actual
- Combustion O₂ – Design (Baseline)
- Combustion O₂ – Deviation
- Total Fired Heat
- Deviation Cost (Lost Steam or Additional Fuel)

Additional Available Outputs

- Heat Loss – Total
- Heat Loss in Dry Gas
- Heat Loss due to Moisture in the Fuel
- Heat Loss in the Moisture Formed from Hydrogen
- Heat Loss in the Moisture in the Supplied Air
- Heat Loss due to Ash
- Heat Loss due to Radiation
- Heat Loss due to Carbon Monoxide
- Temperature – Air Heater Air Inlet Deviation
- Temperature – Air Heater Gas Inlet Deviation
- Temperature – Air Heater Gas Outlet Deviation
- Excess Air – Actual
- Excess Air – Deviation
- Flow Rate – Blowdown (if not supplied)
- Air Heater Leakage

Module: Boiler

Module Process Flow Diagram

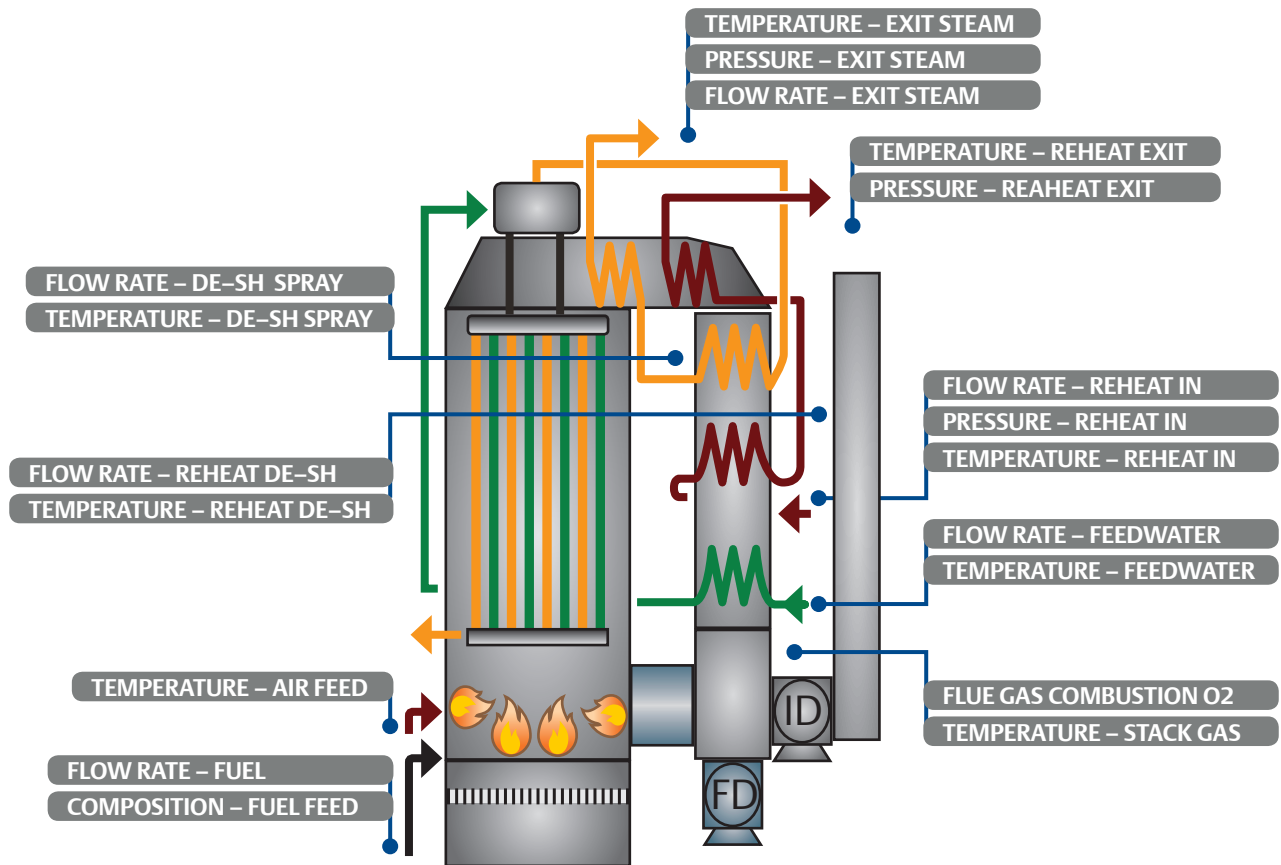

OPTIONAL	
FLOW RATE – FEED AIR	TEMPERATURE(S) – SUPERHEATER(S)
FLOW RATE(S) – SOOT BLOWING STEAM	TEMPERATURE(S) – DE-SH STEAM INLET/EXIT
FLOW RATE – BLOWDOWN	PRESSURE – BOILER FEED WATER
TEMPERATURE – FUEL FEED	PRESSURE(S) – STEAM DRUM
TEMPERATURE – FURNACE FIRING	PRESSURE(S) – INTERMEDIATE SH STEAM
TEMPERATURE – COMBUSTION AIR	STACK EXCESS O ₂
TEMPERATURE(S) – FLUE GAS ALONG PATH	FLUE GAS ANALYSIS
TEMPERATURE(S) – ECONOMIZER EXIT WATER	

Module: Heat Recovery Steam Generator (HRSG)

Module Process Flow Diagram

- See HRSG Figure

Equipment Design Information

- Piping & Instrumentation Diagrams (P&ID)
- OEM Design / Equipment Specification Sheets
- Rated Cases: (50%, 70%, 80%, 90%, 100% load)

Module Inputs

- Flow Rate – Gas Turbine Exhaust (or Estimate)
- Flow Rate* – Steam and/or Feed Water
- Flow Rate(s) – De-Superheater Spray Water (as appropriate)
- Flow Rate – Supplementary Fuel (if Duct Burners Present)
- Flow Rate – Gas Turbine Fuel
- Temperature – Gas Turbine Exhaust / Duct Inlet
- Temperature(s) – De-Superheater Spray Water
- Temperature – Stack Gas
- Temperature* – Boiler Feed Water (BFW)
- Temperature* – Steam Exit
- Pressure* – Steam Exit
- Analysis – Stack Gas Excess O₂ (or Estimate)
- Analysis – Fuel Composition, Heating Value

Optional Inputs If Available

- Flow Rate* – Blowdown
- Flowrate* – Evaporator Circulating Water
- Temperature(s) – Flue Gas Path
- Temperature(s)* – Economizer Exit Water
- Temperature(s)* – Intermediate Superheated Steam
- Temperature – Supplementary Fuel
- Pressure* – Boiler Feed Water (BFW)
- Pressure* – Steam Drum
- Duty – Additional Heat Sinks (e.g. District or Oil Heating)
- Analysis – Flue Gas Analysis (e.g. NO_x / SO_x / CO_x / H₂O)

* Required for each steam pressure level

Module Calculation Method

- ASME PTC 4.4 (input-output and thermal-loss efficiencies)
 - The design efficiency values calculated from performance data in accordance to the PTC definitions:
- Output is the heat absorbed by the working fluids.
- Input is the sensible heat in the exhaust gas supplied to the HRSG, plus the chemical heat in the supplementary fuel, plus the heat credit supplied by the sensible heat in the supplementary fuel.

Module Outputs

- Thermal Efficiency – Actual
- Thermal Efficiency – Design (Baseline)
- Thermal Efficiency – Deviation
- Thermal Efficiency – Thermal Loss Actual
- Thermal Efficiency – Thermal Loss Design
- Thermal Efficiency – Thermal Loss Deviation
- Flow Rate(s) – Steam
- Flow Rate(s) – Steam Design
- Flow Rate(s) – Steam Deviation
- Available Heat
- Deviation Cost (Lost Steam Production)

Additional Available Outputs

- Flow Rate – Blowdown (if not supplied)
- Flue Gas Path Approach Temperatures
- Pinch Point Analysis
- Evaporator Steam Quality*

Module: Heat Recovery Steam Generator (HRSG)

Module Process Flow Diagram

■ Single pressure level

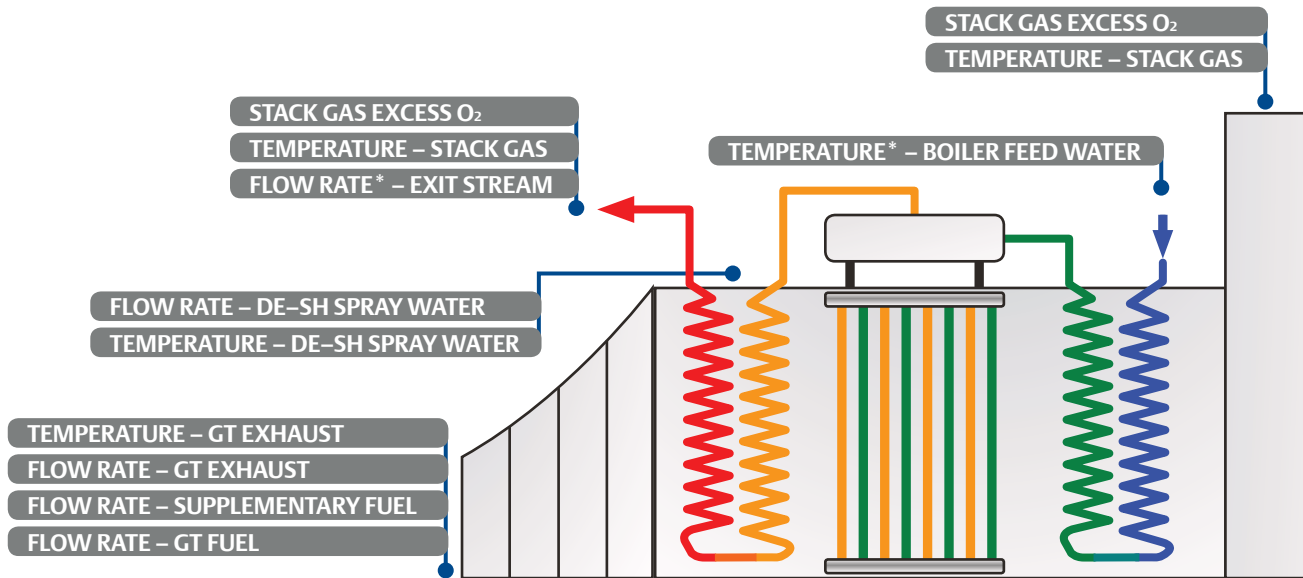

OPTIONAL

FLOW RATE* – BLOWDOWN

TEMPERATURE(S) – FLUE GAS

TEMPERATURE(S) – ECONOMIZER EXIT WATER

TEMPERATURE(S) – INTERMEDIATE SH STEAM

TEMPERATURE – SUPPLEMENTARY FUEL

PRESSURE* – BOILER FEED WATER

PRESSURE* – STEAM DRUM

FUEL COMPOSITION – SUPPLEMENTARY FUEL

ADDITIONAL HEAT SINKS (E.G. DISTRICT HEATING)

FLUE GAS ANALYSIS

Module: Fired Heater / Furnace

Module Process Flow Diagram

- See Fired Heater Figure

Equipment Design Information

- Piping & Instrumentation Diagrams (P&ID)
- OEM Design / Equipment Specification Sheets
- Rated Cases: (50%, 70%, 80%, 90%, 100% load)

Module Inputs

- Fuel – Feed Composition, Heating Values
- Flow Rate(s) – Fuel
- Flow Rate(s) – Process
- Temperature – Feed Air
- Temperature – Process Inlet
- Temperature(s) – Process Exit
- Temperature – Stack Gas
- Pressure(s) – Process Inlet / Exit
- Analysis – Combustion O₂

Optional Inputs If Available

- Flow Rate – Feed Air
- Flow Rate – Heat Recovery Medium (e.g. steam)
- Temperature – Fuel Feed
- Temperature – Furnace Firing
- Temperature – Combustion Air
- Temperature(s) – Heat Recovery Medium (e.g. steam)
- Temperature(s) – Intermediate Process
- Temperature(s) – Flue Gas Path
- Pressure(s) – Intermediate Process Superheater
- Pressure(s) – Heat Recovery Medium (e.g. steam)
- Analysis – Stack Excess O₂
- Analysis – Flue Gas (e.g. NO_x / SO_x / CO_x / H₂O)

Module Calculation Method

- ASME PTC

Module Outputs

- Efficiency – Actual (Heat Loss and Input / Output)
- Efficiency – Design (Baseline)
- Efficiency – Deviation
- Flow Rate – Process Actual
- Flow Rate – Process Design (Baseline)
- Flow Rate – Process Deviation
- Combustion O₂ – Actual
- Combustion O₂ – Design (Baseline)
- Combustion O₂ – Deviation
- Total Fired Heat
- Deviation Cost (Additional Fuel Consumption)

Additional Available Outputs

- Heat Loss – Total
- Heat Loss in Dry Gas
- Heat Loss due to Moisture in the Fuel
- Heat Loss in the Moisture Formed from Hydrogen
- Heat Loss in the Moisture in the Supplied Air
- Heat Loss due to Ash
- Heat Loss due to Radiation
- Heat Loss due to Carbon Monoxide
- Process Duty
- Process Approach Temperature
- Additional Heat Recovery Duty

Module: Fired Heater / Furnace

Module Process Flow Diagram

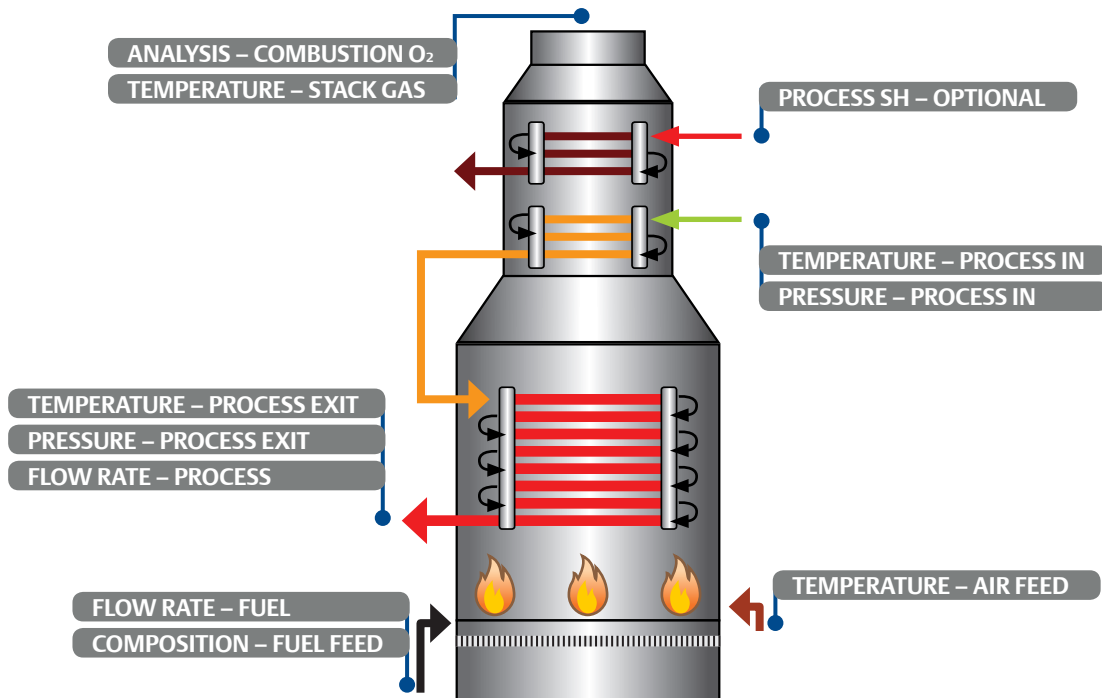

- OPTIONAL**
- FLOW RATE - FEED AIR
 - FLOW RATE - HEAT RECOVERY MEDIUM
 - TEMPERATURE - FUEL FEED
 - TEMPERATURE - FURNACE FIRING
 - TEMPERATURE - COMBUSTION AIR
 - TEMPERATURE(S) - HEAT RECOVERY MEDIUM
 - TEMPERATURE(S) - INTERMEDIATE PROCESS
 - TEMPERATURE(S) - FLUE GAS ALONG PATH
 - PRESSURE(S) - INTERMEDIATE PROCESS
 - PRESSURE(S) - HEAT RECOVERY MEDIUM
 - STACK GAS EXCESS O₂
 - FLUE GAS ANALYSIS

Module: Condenser (Air Cooled)

Module Process Flow Diagram

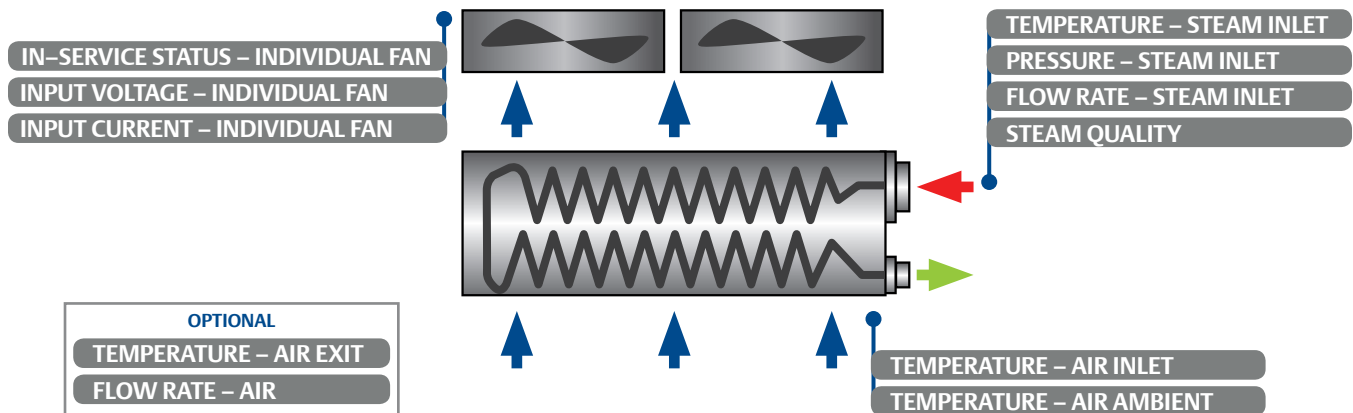

Equipment Design Information

- Piping & Instrumentation Diagrams (P&ID)
- OEM Design / Equipment Specification Sheets
- Operating Curves: Capacity Versus Ambient Temperature

Module Inputs

- Flow Rate – Steam Inlet (or Condensate)
- Temperature – Steam Inlet (or Condensate)
- Temperature – Condensate (if Subcooled)
- Temperature – Air Inlet
- Temperature – Air Ambient
- Pressure – Steam Inlet
- Steam Quality (if at Saturation)
- In-Service Status – Individual Fan (as appropriate)
- Input Voltage – Individual Fan (as appropriate)
- Input Current – Individual Fan (as appropriate)

Optional Inputs If Available

- Temperature – Air Exit
- Flow Rate – Air

Module Calculation Method

- ASME PTC 12.2 – Model utilizes the standards of Heat Exchange Institute for Steam Surface Condensers.
- ASME PTC 30.1 – Utilized with forced air draft systems.

Module Outputs

- Efficiency – Actual (Overall Duty)
- Efficiency – Design (Baseline Duty)
- Efficiency – Deviation
- Heat Transfer Coefficient – Overall
- Heat Transfer Coefficient – Design (Baseline)
- Heat Transfer Coefficient – Deviation
- Capacity (Heat Duty)
- Deviation Cost

Additional Available Outputs

- Temperature(s) – Approach
- LMTD (as appropriate)
- Air Temperature Rise

Module: Condenser (Water Cooled)

Module Process Flow Diagram

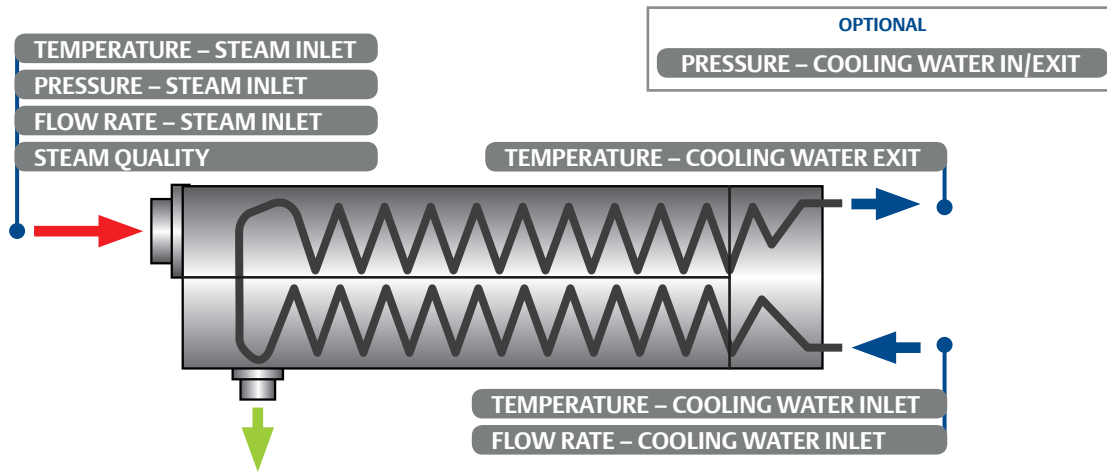

Equipment Design Information

- Piping & Instrumentation Diagrams (P&ID)
- OEM Design / Equipment Specification Sheets
- Operating Curves: Capacity Versus Ambient Temperature

Module Inputs

- Flow Rate – Steam Inlet
- Flow Rate – Cooling Water Inlet
- Temperature – Steam Inlet
- Temperature – Condensate (if Subcooled)
- Temperature – Cooling Water Inlet
- Temperature – Cooling Water Exit
- Pressure – Steam Inlet
- Steam Quality (if at Saturation)

Optional Inputs If Available

- Pressure(s) – Cooling Water In / Exit

Module Calculation Method

- ASME PTC 12.2 – Model utilizes the standards of Heat Exchange Institute for Steam Surface Condensers.

Module Outputs

- Efficiency – Actual (Overall Duty)
- Efficiency – Design (Baseline Duty)
- Efficiency – Deviation
- Heat Transfer Coefficient – Overall
- Heat Transfer Coefficient – Design (Baseline)
- Heat Transfer Coefficient – Deviation
- Capacity (Heat Duty)
- Deviation Cost

Additional Available Outputs

- Temperature(s) – Approach
- LMTD
- Cooling Water Pressure Drop
- Water Temperature Rise

Module: Heat Exchanger

Module Process Flow Diagram

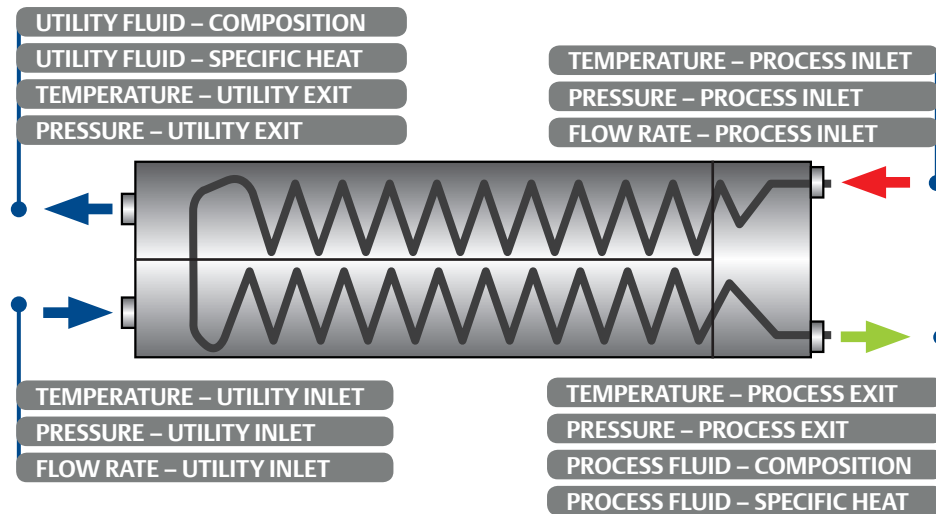

Equipment Design Information

- Piping & Instrumentation Diagrams (P&ID)
- OEM Design Specification Sheets
- Operating Curves: Duty Versus Utility Flow, Duty Versus Utility Pressure

Module Calculation Method

- ASME PTC 12.5 – Utilized in single phase applications.
- ASME PTC 30 (Air Cooled) – Utilized in air cooled single phase applications.

Module Inputs

- Flow Rate – Process Inlet
- Flow Rate – Utility Inlet
- Temperature – Process Inlet
- Temperature – Process Exit
- Temperature – Utility Inlet
- Temperature – Utility Exit
- Pressure – Process Inlet
- Pressure – Process Exit
- Pressure – Utility Inlet
- Pressure – Utility Exit
- Utility Fluid Composition
- Utility Fluid Specific Heat Capacity (Cp)
- Process Fluid Composition (if available)
- Process Fluid Specific Heat Capacity (Cp)

Module Outputs

- Efficiency – Actual (Overall Duty)
- Efficiency – Design (Baseline Duty)
- Efficiency – Deviation
- Heat Transfer Coefficient – Overall
- Heat Transfer Coefficient – Design (Baseline)
- Heat Transfer Coefficient – Deviation
- Capacity (Heat Duty)
- Deviation Cost (Increased Utility Consumption)

Additional Available Outputs

- Temperature(s) – Approach
- Temperature Change – Utility
- Temperature Change – Process
- LMTD (as appropriate)

Module: Cooling Tower

Module Process Flow Diagram

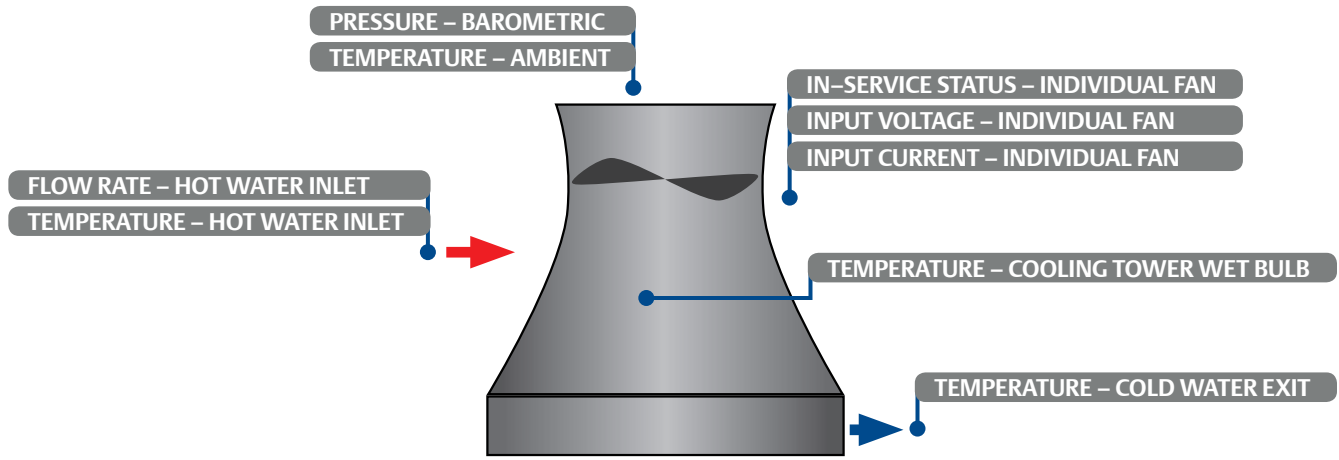

Equipment Design Information

- Piping & Instrumentation Diagrams (P&ID)
- OEM Design / Equipment Specification Sheets
- Operating Curves: Duty Versus Cooling Water Flow, Duty Versus Ambient Temp

Module Calculation Method

- AMS PTC 23

Module Inputs

- Flow Rate – Water Inlet
- Temperature – Water Inlet
- Temperature – Water Exit
- Temperature – Cooling Tower Wet Bulb
- Temperature – Ambient
- Pressure – Barometric
- In-Service Status – Individual Fan (as appropriate)
- Input Voltage – Individual Fan (as appropriate)
- Input Current – Individual Fan (as appropriate)

Module Outputs

- Cooling Tower Capability – Actual
- Cooling Tower Capability – Design
- Cooling Tower Capability – Deviation
- Capacity (Heat Duty)
- Deviation Cost (Increased Fan Power Consumption or Additional Cool Water required)

Additional Available Outputs

- Temperature(s) – Approach

Module: 2nd Equipment of Same Manufacturer and Model Number

- Applies to any Equipment Module
- Equipment must be of same Manufacturer and Model Number
- If Equipment is not similar, an additional Equipment Module must be utilized

Module: Large Pump

Module Process Flow Diagram

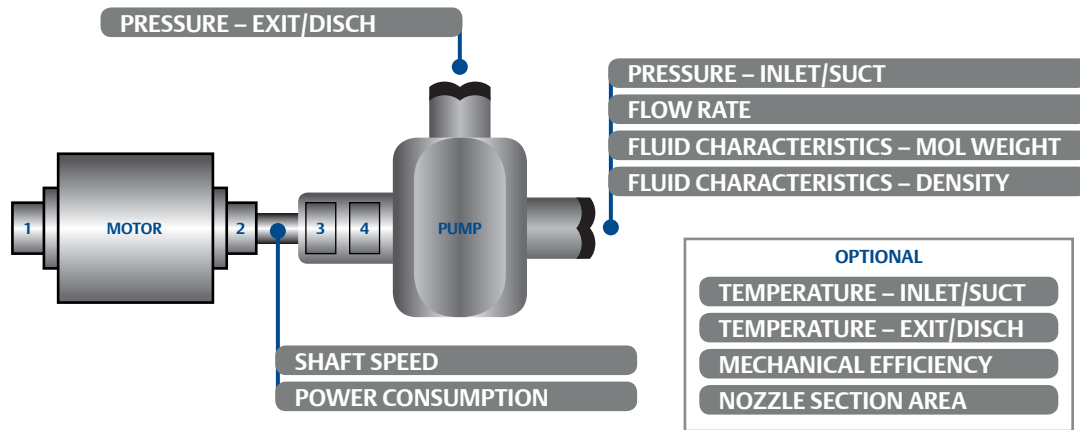

Equipment Design Information

- Piping & Instrumentation Diagrams (P&ID)
- OEM Design / Equipment Specification Sheets
- Operating Curves: Head Versus Flow, Efficiency Versus Flow, Power Versus Flow
- Rated Cases: 60%, 80%, 90%, 100% load or at a constant rated speed

Module Inputs

- Flow Rate – Measurement point inside any recycle loops
- Pressure – Inlet / Suction
- Pressure – Exit / Discharge
- Shaft Speed (on variable speed machines)
- Power Consumption (or Motor Current, Volts, and pF)
- Fluid Characteristics – Density
- Fluid Characteristics – Molecular Weight

Optional Inputs If Available

- Mechanical Efficiency (Shaft)
- Temperature – Inlet / Suction
- Temperature – Exit / Discharge
- Nozzle Suction Area

Module Calculation Method

- ASME PTC 8.2 – Pump efficiency, head and corrected head are calculated. Design pump head is calculated from the pump characteristic curve.

Module Outputs

- Efficiency – Actual (Overall Duty)
- Efficiency – Design (Baseline Duty)
- Efficiency – Deviation
- Pump Head – Actual
- Pump Head – Design
- Pump Head – Deviation
- Pump Head – Corrected
- Deviation Cost (Lost Throughput or Additional Power Consumption)

Additional Available Outputs

- Flow Rate – Volumetric
- Velocity – Suction
- Velocity – Discharge
- Velocity Head – Suction
- Velocity Head – Discharge
- Pressure Ratio
- Speed – Design
- Power – Actual
- Power – Specific
- Power – Corrected

Module: Large Fan

Module Process Flow Diagram

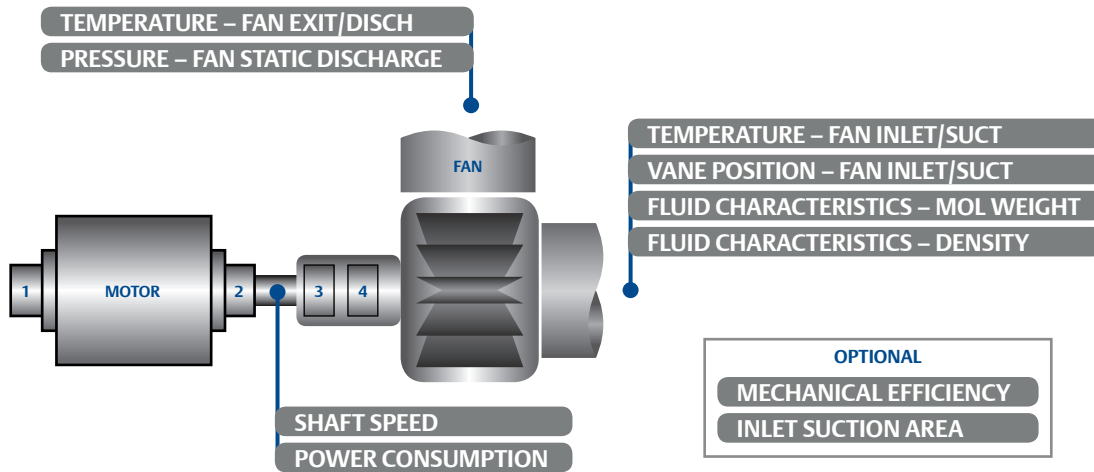

Equipment Design Information

- Piping & Instrumentation Diagrams (P&ID)
- OEM Design / Equipment Specification Sheets
- Operating Curves: Head Versus Flow, Efficiency Versus Flow, Power Versus Flow
- Rated Cases: e.g., 100% load, 90% load, or single-speed unit

Module Inputs

- Pressure – Fan Static Discharge
- Vane Position – Fan Inlet / Suction
- Temperature – Fan Inlet / Suction
- Temperature – Fan Exit / Discharge
- Power Consumption (or Motor Current, Volts and pF)
- Shaft Speed (on variable speed machines)
- Fluid Characteristics – Density
- Fluid Characteristics – Molecular Weight

Optional Inputs If Available

- Mechanical Efficiency (Shaft)
- Inlet Suction Area

Module Calculation Method

- ASME PTC 11 – Computes the efficiency of forced draft, induced draft, and primary and secondary air fans. Design efficiencies are computed based on manufacturer’s design data and deviations are reported.

Module Outputs

- Efficiency – Actual
- Efficiency – Design
- Efficiency – Deviation
- Fan Power – Actual
- Fan Power – Design
- Fan Power – Deviation
- Static Pressure – Deviation
- Deviation Cost (Lost Throughput or Additional Power Consumption)

Additional Available Outputs

- Flow Rate – Volumetric
- Velocity – Suction
- Velocity – Discharge
- Velocity Head – Suction
- Velocity Head – Discharge
- Pressure Ratio

Workstation Specifications

AMS Performance Advisor operates on a dedicated workstation computer that has a Microsoft Windows operating system. For all DCS and historian types, the interface utilizes standard Ethernet (TCP/IP). Data is transferred via an OPC Server or OSI PI provided separately by the DCS or Historian manufacturer.

AMS Performance Advisor is initially installed on a dedicated master workstation. The master workstation can be a server or standard computer as recommended below. AMS Performance Advisor can be accessed at multiple workstations on the same network, simply requiring an installation of AMS Asset Graphics connection to the master workstation (requires a multi-user license).

Minimum Requirements	
Operating Systems	Windows XP Pro SP3 or Windows 2003 Server (Vista not supported)
Processor	2 GHz Pentium, 2 GB RAM (XP)
Hard Drive	100 GB disk space
Network	Ethernet (TCP/IP protocol)
Browser	Internet Explorer 6 or later
Screen Resolution	XGA (1024 x 768)
Other	USB 1.1 port, PDF Reader

Recommended Requirements	
Operating Systems	Windows XP Pro SP3 or Windows 2003 Server (Vista not supported)
Processor	3 GHz Dual Core Pentium, 4 GB RAM (XP)
Hard Drive	250+ GB disk space
Network	Ethernet (TCP/IP protocol)
Browser	Internet Explorer 7 or later
Screen Resolution	SXGA (1280 x 1024) WSXGA (1680 x 1050)
Other	USB 2.0 port, PDF Reader, and Microsoft Office Software

Core License

Part	Number	Product Description
MHM-AMSPA-CORE-LICENSE-US		AMS Performance Advisor Core License, 1st Yr Tuning 1x/Qtr
MHM-AMSPA-CORE-LICENSE-WA		AMS Performance Advisor Core License, 1st Yr Tuning 1x/Qtr

Equipment Modules

Part	Number	Product Description
MHM-AMSPA-MOD-COMP RECIP		Module: Compressor - Reciprocating
MHM-AMSPA-MOD-COMP CENTRF		Module: Compressor - Centrifugal
MHM-AMSPA-MOD-GAS TURBINE		Module: Gas Turbine
MHM-AMSPA-MOD-STEAM TURN		Module: Steam Turbine
MHM-AMSPA-MOD-HEAT EXCHAN		Module: Heat Exchanger
MHM-AMSPA-MOD-BOILER		Module: Boiler
MHM-AMSPA-MOD-HEATER		Module: Heater
MHM-AMSPA-MOD-FURNACE		Module: Furnace
MHM-AMSPA-MOD-CONDENSER		Module: Condenser
MHM-AMSPA-MOD-HRSG		Module: HRSG
MHM-AMSPA-MOD-LARGE PUMP		Module: Large Pump
MHM-AMSPA-MOD-LARGE FAN		Module: Large Fan
MHM-AMSPA-MOD-COOLING TWR		Module: Cooling Tower
MHM-AMSPA-MOD-2ND SIMILAR		Module: 2nd Equipment of Module Type (requires same mfg & model #)

AMS Asset Graphics

Part	Number	Product Description
PMS-LZ-30000		AMS Asset Graphics, Standalone Runtime Lic, 30000 elements
PMS-LZ-30000-FLOAT-X		AMS Asset Graphics, X Floating Network Runtime Lic, 30000 elements
MHM-INST-AMSAG-AMSPA 1MOD		AMS Asset Graphics, per 1 Module, Install Services
MHM-INST-AMSAG-CUSTOM 3LD		AMS Asset Graphics, customization 3 Labor Days, Install Services

NOTE: See AMS Asset Graphics Price List for X floating runtime license beyond 2.

Dedicated Work Station PC

Part	Number	Product Description
A4500H3		Computer Work Station to run AMS Performance Advisor, 110v
A4500H3-IN		Computer Work Station to run AMS Performance Advisor, 220v, NON-US destination
call factory		Touch Panel PC to run AMS Performance Advisor or AMS Asset Graphics

NOTE: Customer may provide a work station computer that meets the specifications stated in the product data sheet.

Ongoing Services

Part	Number	Product Description
MHM-AMSPA-TUNE ANNUAL-4X		Ongoing Tuning per year (4x/Yr)
MHM-AMSPA-TUNE ANNUAL-6X		Ongoing Tuning per year (6x/Yr)
SUPPORT-AMSPA		AMS Performance Advisor Software Support, 1 YEAR, after 1st year
ATC-2040xx		AMS Performance Advisor training, 3 days

Where "XX" is KN-Knoxville, TN; AU-Austin, TX; RE-Regional Training Facility; CS-Customer Site

How to Order

Using the part numbers for each respective element, choose one of each of the following:

- Core License
- Equipment Modules
- 2nd Similar Equipments
- AMS Asset Graphics
- Dedicated workstation
- All services necessary to execute set-up phases are included

Emerson Process Management
Asset Optimization
835 Innovation Drive
Knoxville, TN 37932
T (865)675-2400
F (865)218-1401
www.assetweb.com

©2013, Emerson Process Management.

The contents of this publication are presented for informational purposes only, and while every effort has been made to ensure their accuracy, they are not to be construed as warranties or guarantees, express or implied, regarding the products or services described herein or their use or applicability. All sales are governed by our terms and conditions, which are available on request. We reserve the right to modify or improve the designs or specifications of our products at any time without notice.

All rights reserved. AMS, PeakVue, and Machinery Health are marks of one of the Emerson Process Management group of companies. The Emerson logo is a trademark and service mark of Emerson Electric Co. All other marks are the property of their respective owners.

