

Hoja de datos del producto

Número de hoja: ES1.603.06 - Rev: A

Fecha: Septiembre, 2006

FieldQ

Dimensiones del actuador de válvulas FieldQ

Actuadores en sistema imperial - ISO5211 / Placa NAMUR

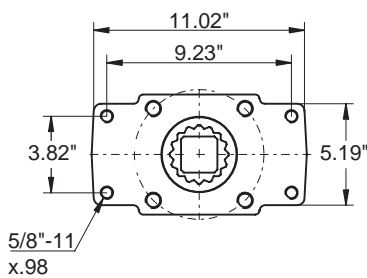
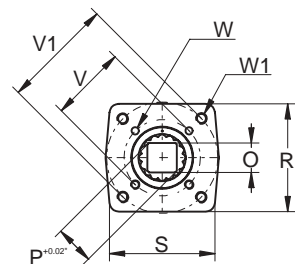
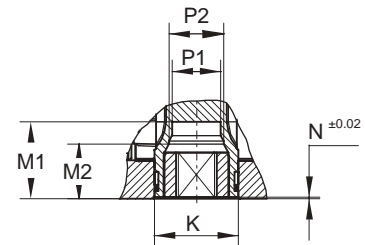
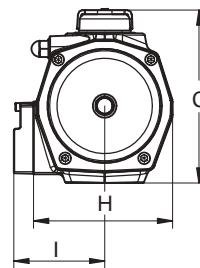
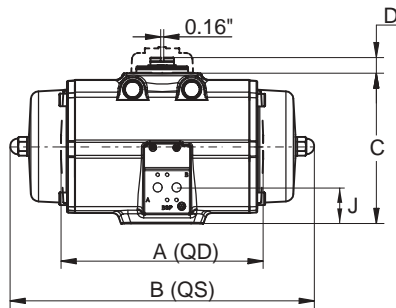
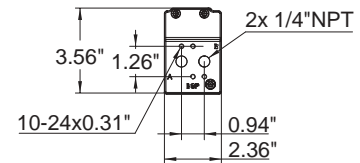
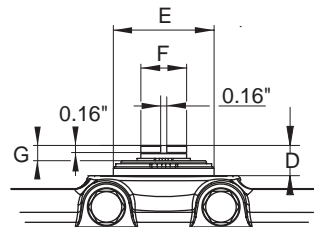
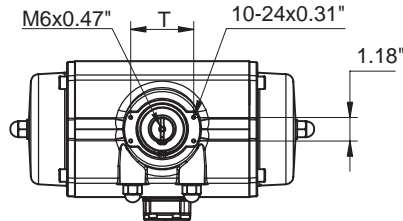

Nota:

1. Las dimensiones están en pulgadas.
2. Los tornillos limitadores en el Q40 y el Q65 están del lado opuesto al lado donde se encuentran en los actuadores más grandes.

Dim.	Modelos de actuadores FieldQ™								
	Q40	Q65	Q100	Q150	Q200	Q 350	Q600	Q950	Q1600
A QD	7.09	7.83	8.70	12.20	11.14	12.01	15.24	16.69	20.31
B QS	7.95	9.80	10.00	8.31	14.09	15.35	16.50	18.09	22.34
C	4.09	4.59	5.55	5.91	6.30	7.52	9.65	10.87	13.27
C'	5.39	5.92	6.89	7.24	7.64	8.86	11.38	12.56	14.96
D	0.79	0.79	0.79	0.79	0.79	0.79	1.18	1.18	1.18
E	2.20	2.20	2.20	2.56	2.60	2.60	3.43	3.78	3.74
F	0.63	0.71	0.79	0.87	1.18	1.18	1.38	1.38	1.77
G	0.37	0.35	0.43	0.39	0.35	0.39	0.77	0.75	1.12
H	3.54	4.02	4.53	5.08	5.31	6.97	8.23	9.21	10.55
I	2.95	3.19	3.46	3.82	3.90	4.69	5.28	5.79	6.46
J	1.56	1.56	1.97	1.81	1.78	1.81	2.08	2.20	2.75
K	1.30	1.30	1.50	2.17	2.17	2.17	2.68	2.95	3.74
M1	1.36	1.36	1.36	1.97	1.97	1.97	1.97	2.56	3.19
M2	-	-	1.06	-	1.46	1.46	-	-	-
N	0.04	0.04	0.06	0.04	0.06	0.06	0.06	0.06	0.06
O max.	0.556	0.556	0.753	0.753	0.871	1.068	1.068	1.424	1.817
O min.	0.551	0.551	0.748	0.748	0.866	1.063	1.063	1.417	1.811
P	0.71	0.71	0.99	0.99	1.11	1.43	1.43	1.90	2.37
P1	0.71	0.83	0.93	1.12	1.27	1.27	1.45	1.90	2.38
P2	-	-	0.99	-	1.43	1.43	-	-	-
R	2.56	2.76	2.76	3.54	3.54	4.49	4.88	5.12	6.06
S	2.56	2.76	2.76	3.54	3.54	4.49	4.88	5.59	11.02
T	3.15	3.15	3.15	3.15	3.15	3.15	5.12	5.12	5.12
PCD	F05/F07	F05/F07	F05/F07	F07/F10	F07/F10	F07/F10	F10/F12	F10/F14	F16/F25*
V	1.969	1.969	1.969	2.756	2.756	2.756	4.016	4.016	6.496
V1	2.756	2.756	2.756	4.016	4.016	4.016	4.921	5.512	-
W	1/4"	1/4"	1/4"	5/16"	5/16"	5/16"	3/8"	3/8"	3/4"
o	20x.39	20x.39	20x.39	18x.39	18x.39	18x.39	16x.63	16x.63	10x1.14
W1	5/16"	5/16"	5/16"	3/8"	3/8"	3/8"	1/2"	5/8"	-
o	18x.39	18x.39	18x.39	16x.63	16x.63	16x.63	13x.79	11x.98	0



www.FieldQ.com

Copyright © Emerson Process Management La información de este documento puede sufrir cambios sin previo aviso. Puede obtener hojas de datos actualizadas en nuestro sitio Web www.FieldQ.com o en el Centro de Automatización de Válvulas más cercano: **América:** +1 813 630 2255 (fax +1 630 9449) **Europa:** +31 74 256 10 10 (fax +31 74 291 09 38) **Asia/Pacífico:** +65 626 24 515 (fax +65 626 80 028)



EMERSON
Process Management