

## The GO™ Switch Proximity Principle

Single-magnet 80 Series GO Switches are designed for use with two independent circuits. A ferrous armature is positioned off-center, creating dominance and placing the contacts for both circuits in a Normally Closed (N/C) position (Figure 1).

When a ferrous actuator enters the sensing area of the switch (Figure 2), it deflects magnetic flux from the N/C side of the armature and the Normally Open (N/O) side becomes dominant. The armature then snaps to its alternate position, closing the N/O contacts. When the actuator is removed, the magnet again becomes dominant on the N/C side and the armature returns to its N/C position.

## SPECIFICATIONS - DPDT

**Contacts:** Double Pole, Double Throw, 2 Form C., Silver cadmium oxide, gold flashed

**Rating:** 1250 watts @ 120, 240, 480 or 600 VAC. Maximum cycle rate of 10 cycles per minute resistive load at 10 amps.

**Housing:** Environmentally sealed brass or stainless steel

**Conduit Outlet:** 1/2" -14NPT

**Repeatability:** 0.002" (0.05mm) typical

**Sensing Distance:** Approx. 1/4" (7mm)

(7mm) end sensing. (NOTE: Sensing distance may be affected by surrounding ferrous materials and actuator size)

**Differential:** Approx. 1/4" (72mm)

**Response time:** 8 milliseconds

**Temperature Rating:** -40°F.

(-40°C) to 221°F (105°C)

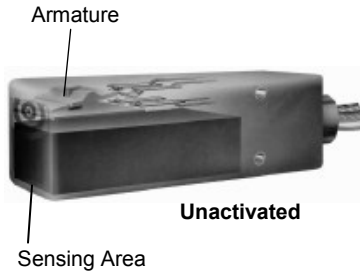

Unactivated



Activated

## Standard GO Switch Actuators

The part to be sensed can approach or pass across the sensing area from any direction. This permits unlimited over-travel and a wide variety of operating conditions.

**CAUTION:** To assure optimum switch operation, the actuator speed should exceed 2 FPS (feet per second).

## Switch Sensing

Target should be either ferrous metal the size of the sensing face and 1/4" thick or a TopWorx Target Magnet. Maximum sensing with the recommended ferrous target is 5/16". TopWorx recommends that the target be set at 50% of that distance if possible, to compensate for actuator wear and repeatability over time. Target magnets are available from TopWorx to extend the sensing range of the switch.

**NOTE:** Actuator size effects sensing distance.

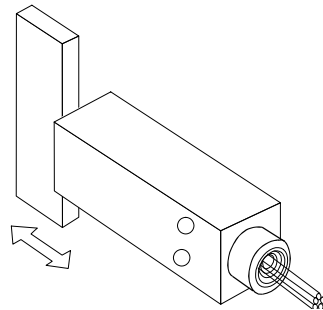

## Mounting

- Determine the desired operating point.
- Locate switch and/or actuator to assure that actuator comes well within switch's sensing area.
- Use a ferrous actuator of sufficient size.
- Recommended sensing is one half the published sensing range for trouble free operation with a repeatable target. If target sensing area needed is greater, there are multiple target magnets available from TopWorx to extend the range of the switch.
- Avoid contact between switch and actuator, which may damage switch.
- For best results, mount switch on non-ferrous materials.
- Steel placed outside the switch's differential area will not affect functionality.
- We do not recommend that GO Switches be mounted to ferrous metal. If a ferrous mount is the only option consult factory. The switch must be centered on the bracket to avoid latching and the maximum sensing distance will be reduced by approximately 50%. A target magnet is highly suggested in that case.
- Ferrous brackets or surrounding ferrous metal should NOT be applied to the top of the switch above the sensing area...Latching may occur.
- Switch must be centered on ferrous mounting bracket so that effects on the magnet are uniform.

## Attachment of Conduit or Cable

Attach conduit or cable correctly.

- When using long runs of conduit or cable, place supports close to the switch to avoid pulling switch out of position.
- If switch is mounted on a moving part, be sure flexible conduit is long enough to allow for movement, and positioned to eliminate binding or pulling.
- For installation in hazardous locations, check local electrical codes.
- All conduit connected electrical devices, including GO Switches, must be sealed against water ingress through the conduit system. In figure 1, something common has occurred, the conduit system has filled with water. Over a period of time this may cause the switch to fail prematurely. In figure 2, the termination of the switch has been carefully filled with electronics grade RTV to prevent water ingress and to prevent premature switch failure. A drip loop with provision for water to escape has also been installed.

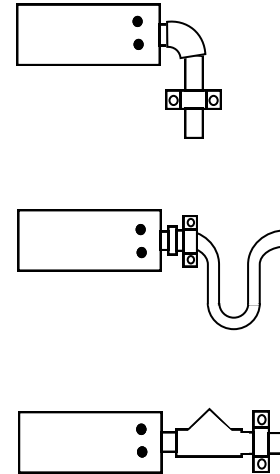

## EC Declaration of Conformity

The products described herein, conform to the provisions of the following European Community Directives, including the latest amendments:

Low Voltage Directive (2006/95/EC)

EMC Directive (2004/108/EC)

Machinery Directive (2006/42/EC)

ATEX Directive (94/9/EC).

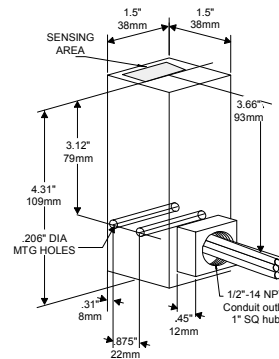
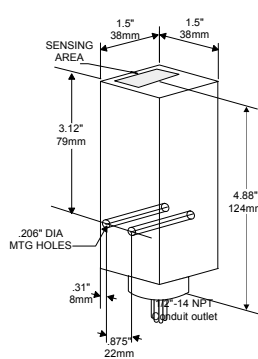

All GO Switches are "pure" contact switches, meaning they have no voltage drop when closed, nor do they have any leakage current when open. For multi-unit installation, switches may be wired in series or parallel, as shown.

## Series Wiring

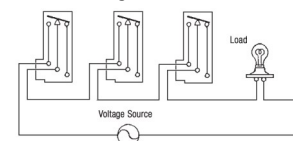

Any number of GO Switches may be wired in series, without voltage drop. By contrast, solid state switches have about two volts drop across the switch when operated. In a 12 volt solid state system with four switches in series, 8 volts is dropped across the switches. Only 4V is left to operate the load. When using GO Switches, 12V is still available to operate the load. (Except 7L - approx. 5V drop)

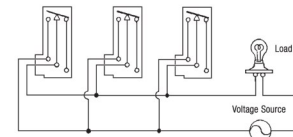

## Parallel Wiring

When solid state switches are placed in parallel, there is about 100 microamps leakage through each switch. If ten solid state switches were wired in parallel, the total leakage current would be 1000 microamps or one milliamp - sufficient current to indicate an "ON" condition to a programmable logic controller (PLC). Any number of GO® Switches may be wired in parallel, with no current leakage and without drawing operating current. (Except 7L - approx. 5V drop)

**NOTE:** Occasionally the 80 Series DPDT is used for its end sensing, when only a SPDT switch is required. If this is the case in your application it is to your best advantage to parallel the lead wires (red to red/white stripe, blue to blue/white stripe and black to black/white stripe, essentially converting a DPDT switch to a SPDT configuration) so that both individual circuits see the same load and therefore wear equally to give long contact life and the reliable service you expect with GO® Switch.

Contact Chamber is potted to resist contaminants. Please see notes on conduit installation. Optional connectors available for excessive moisture and submersed conditions



Multiple termination options: Lead wires, Cable, Quick Disconnects

## GO® Switch Hook-up Diagrams

Form "C" Typ. Dual Load Hook-up

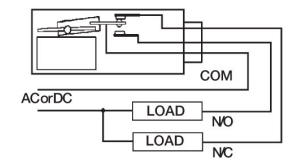

Form "B" Normally Closed Typ. Overtravel or Limits, Hook-up

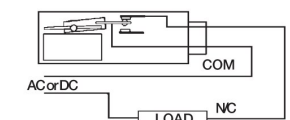

Form "A" Normally Open Typ. Alarm or Limits Warning Hook-up

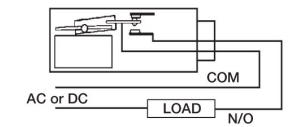

## Dual Form C

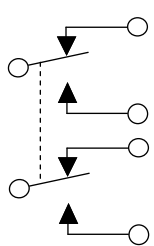

## DPDT



## Wiring Diagrams

### SPDT, FORM C

4 Wire PVC & HiTemp Leads	
N/C	Red
N/O	Blue
COM	Black
GND	Green

#### Terminations A & F

### SPDT, FORM C

Mini-Change QDC - 3 Pin	
Pin 1	COM (Green)
Pin 2	N/C (Black)
Pin 3	N/O (White)

#### Termination DCA

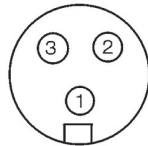

### SPDT, FORM C

Mini-Change QDC - 5 Pin	
Pin 1	N/O (White)
Pin 2	N/C (Red)
Pin 3	GND (Green)
Pin 4	Inactive (Orange)
Pin 5	COM (Black)

#### Termination DCG

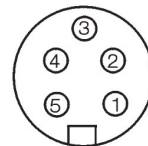

SubSea - 3 Pin - Right Angle	
Pin 1	COM (Black)
Pin 2	N/O (White)
Pin 3	N/C (Green)

#### Termination 3DE



### SPDT, FORM C

SO Cable	
N/C	Red
N/O	White
COM	Black
GND	Green

#### Termination B

### SPDT, FORM C

Mini-Change QDC - 4 Pin	
Pin 1	COM (Black)
Pin 2	N/O (White)
Pin 3	N/C (Red)
Pin 4	GND (Green)

#### Termination DCD

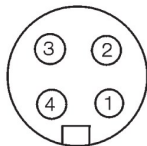

### SPDT, FORM C

SubSea - 3 Pin - Lock Sleeve	
Pin 1	N/C (Black)
Pin 2	COM (White)
Pin 3	N/O (Green)

#### Termination 3DD

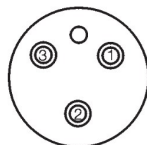

SubSea - 8 Pin - Lock Sleeve	
Pin 1	COM <sub>1</sub> (Black)
Pin 2	N/O <sub>1</sub> (White)
Pin 3	N/C <sub>1</sub> (Red)
Pin 4	GND <sub>1</sub> (Green)
Pin 5	N/C <sub>2</sub> (Orange)
Pin 6	N/O <sub>2</sub> (Blue)
Pin 7	COM <sub>2</sub> (White/Black)
Pin 8	Inactive (Red/Black)

### TERMS AND CONDITIONS OF SALE

These terms and conditions, the attendant quotation or acknowledgment, and all documents incorporated by reference therein, binds TopWorx, Inc. hereinafter the Seller, and the buyer, hereinafter Buyer, and constitutes the entire agreement (Agreement) between Buyer and Seller for the provision of services (Services) and/or the sale of goods (Goods) including (except as provided in Section 10) firmware incorporated therein.

**1. PRICES:** Unless otherwise specified by Seller, Seller's price for the Goods and/or Services shall remain in effect for thirty (30) days after the date of Seller's quotation or acceptance of the order for the Goods/Services, whichever is delivered first, provided an unconditional, complete authorization for the immediate manufacture and shipment of the Goods and/or provision of Services pursuant to Seller's standard order processing procedures is received and accepted by Seller within such time period. If such authorization is not received by Seller within such thirty (30) day period, Seller shall have the right to change the price for the Goods/Services to Seller's price in effect for the Goods/Services at the time the order is released to final manufacture. Prices for Goods do not cover storing, installing, starting up or maintaining Goods unless expressly stated in Seller's quotation. Notwithstanding the foregoing, the price for Goods/Services sold by Seller, but manufactured by others, shall be Seller's price in effect at the time of shipment to Buyer.

**2. DELIVERY ORDER ACCEPTANCE AND DOCUMENTATION:** All shipping dates are approximate and are based upon Seller's prompt receipt of all necessary information from Buyer to properly process the order. Notwithstanding any provisions to the contrary in this or other documents related to this transaction, and regardless of how price was quoted, whether FOB, FAS, CIF or otherwise, legal title to the Goods and risk of loss thereto shall transfer to Buyer as follows: for sales in which the end destination of the Goods is within the United States, upon delivery to the freight carrier at the shipping point, for sales in which the end destination of the Goods is outside of the United States, immediately after the Goods have passed beyond the territorial limits of the United States. Seller shall provide Buyer with that data/documentation which is specifically identified in the quotation. If additional copies of data/documentation or non-standard data/documentation are to be provided by Seller, they shall be provided to Buyer at Seller's price then in effect. Data/documentation marked as confidential or proprietary may not be reproduced or used for any purpose other than the purpose for which it was provided and may not be disclosed to third parties without the prior written permission of Seller.

**3. EXCUSE OF PERFORMANCE:** Seller shall not be liable for delays in performance or for non-performance due to failure or interruption of computer or telecommunication systems, acts of God, war, riot, fire, terrorism, labor trouble, unavailability of materials or components, explosion, accident, compliance with governmental requests, laws, regulations, orders or actions, or other unforeseen circumstances or causes beyond Seller's reasonable control. In the event of such delay, the time for performance or delivery shall be extended by a period of time reasonably necessary to overcome the effect of the delay.

**4. TERMINATION AND SUSPENSION BY BUYER:** Buyer may terminate or suspend its order for any or all of the Goods/Services covered by the Agreement provided that Buyer gives Seller reasonable advance written notice of such termination or suspension and reimburses Seller for all losses, damages, costs and expenses arising from such termination or suspension.

**5. LIMITED WARRANTY:** Subject to the limitations contained in Section 6 herein, Seller warrants that the licensed firmware embodied in the Goods will execute the programming instructions provided by Seller, and that the Goods manufactured or Services provided by Seller will be free from defects in materials or workmanship under normal use and care. The foregoing warranties will apply until the expiration of the applicable warranty period. All other Goods are warranted for twelve (12) months from the date of shipment by Seller. Consumables and Services are warranted for a period of 90 days from the date of shipment or completion of the Services. Products purchased by Seller from a third party for resale to Buyer ("Resale Products") shall carry only the warranty extended by the original manufacturer. Buyer agrees that Seller has no liability for Resale Products beyond making a reasonable commercial effort to arrange for procurement and shipping of the Resale Products. If Buyer discovers any warranty defects and notifies Seller thereof in writing during the applicable warranty period, Seller shall, at its option, correct any errors that are found by Seller in the firmware or Services or repair or replace F.O.B. point of manufacture that portion of the Goods or firmware found by Seller to be defective, or refund the purchase price of the defective portion of the Goods/Services. All replacements or repairs necessitated by inadequate maintenance, normal wear and usage, unsuitable power sources or environmental conditions, accident, misuse, improper installation, modification, repair, use of unauthorized replacement parts, storage or handling, or any other cause not the fault of Seller are not covered by this limited warranty, and shall be at Buyer's expense. Seller shall not be obligated to pay any costs or charges incurred by Buyer or any other party except as may be agreed upon in writing in advance by Seller. All costs of dismantling, reinstallation and freight and the time and expenses of Seller's personnel and representatives for site travel and diagnosis under this warranty clause shall be borne by Buyer unless accepted in writing by Seller. Goods repaired and parts replaced by Seller during the warranty period shall be in warranty for the remainder of the original warranty period or ninety (90) days, whichever is longer. This limited warranty is the only warranty made by Seller and can be amended only in a writing signed by Seller. THE WARRANTIES AND REMEDIES SET FORTH ABOVE ARE EXCLUSIVE. THERE ARE NO REPRESENTATIONS OR WARRANTIES OF ANY KIND, EXPRESS OR IMPLIED, AS TO MERCHANTABILITY, FITNESS FOR PARTICULAR PURPOSE OR ANY OTHER MATTER WITH RESPECT TO ANY OF THE GOODS OR SERVICES.

**6. LIMITATION OF REMEDY AND LIABILITY:** SELLER SHALL NOT BE LIABLE FOR DAMAGES CAUSED BY DELAY IN PERFORMANCE. THE REMEDIES OF BUYER SET FORTH IN THIS AGREEMENT ARE EXCLUSIVE. IN NO EVENT, REGARDLESS OF THE FORM OF THE CLAIM OR CAUSE OF ACTION (WHETHER BASED IN CONTRACT, INFRINGEMENT, NEGLIGENCE, STRICT LIABILITY, OTHER TORT OR OTHERWISE), SHALL SELLER'S LIABILITY TO BUYER AND/OR ITS CUSTOMERS EXCEED THE PRICE TO BUYER OF THE SPECIFIC GOODS MANUFACTURED OR SERVICES PROVIDED BY SELLER GIVING RISE TO THE CLAIM OR CAUSE OF ACTION. BUYER AGREES THAT IN NO EVENT SHALL SELLER'S LIABILITY TO BUYER AND/OR ITS CUSTOMERS EXTEND TO INCLUDE INCIDENTAL, CONSEQUENTIAL OR PUNITIVE DAMAGES. THE TERM "CONSEQUENTIAL DAMAGES" SHALL INCLUDE, BUT NOT BE LIMITED TO, LOSS OF ANTICIPATED PROFITS, REVENUE OR USE AND COSTS INCURRED INCLUDING WITHOUT LIMITATION FOR CAPITAL, FUEL AND POWER, AND CLAIMS OF BUYER'S CUSTOMERS.

**7. PATENTS:** Subject to the limitations contained in Section 6, Seller shall defend any suits brought against Buyer based on a claim that use of the Goods manufactured by Seller constitutes an infringement of a valid patent of the United States, and shall pay any damages awarded therein against Buyer, provided that Buyer: promptly notifies Seller in writing of the

filing of such suit or the threat thereof, permits Seller to control completely the defense or compromise of such claim of infringement; and provides all reasonable assistance and cooperation requested by Seller for the defense of such suit. In the event that only the Goods manufactured by Seller are held to be infringing in such suit and their use is enjoined, Seller shall, at its sole option and expense, provide a commercially reasonable alternative, including, but not limited to, procuring for Buyer the right to continue using the Goods, replacing them with a non-infringing product or modifying them so they become non-infringing. Buyer agrees that Seller shall not be liable for infringement, and that Buyer shall fully indemnify Seller therefore, if infringement is based upon the use of Goods in connection with goods not manufactured by Seller or in a manner for which the Goods were not designed by the Seller or if the Goods were not designed by the Seller or if the Goods were designed by the Buyer or were modified by or for the Buyer in a manner to cause them to become infringing.

**8. TAXES:** Any tax or governmental charge payable by the Seller because of the manufacture, sale or delivery of the Goods, or provision of Services, may at Seller's option be added to the price herein specified. The foregoing shall not apply to taxes based upon Seller's net income.

**9. TERMS OF PAYMENT:** Subject to the approval of Seller's Credit Department, terms are F.O.B. shipping point, net 30 days from date of Seller's invoice in U.S. currency, except for applicable milestone payments covered below or export shipments for which Seller may require other arrangements. Freight charges may include shipping and handling charges, and Buyer shall pay all such charges. If any payment owed to Seller hereunder is not paid when due, it shall bear interest at a rate 1-1/2% per month interest from the date on which it is due until it is received and future shipments may be placed on hold. Seller shall have the right, among other remedies, either to terminate the Agreement or to suspend further deliveries under this and/or other agreements with Buyer in the event Buyer fails to make any payment hereunder when due. Buyer shall be liable for all expenses attendant to collection of past due amounts, including attorneys' fees. Unless otherwise provided in Seller's written quotation, periodic milestone payments shall be made by Buyer when the purchase price of this Agreement exceeds \$100,000. In such cases, invoices shall be issued by Seller and paid by Buyer based on the following milestones: Milestone 1: 30% of price upon acceptance of order by Seller. Milestone 2: 30% of price upon release by Seller of approved bills of material to manufacturing for assembly. Milestone 3: 40% of price upon shipment of the Goods by Seller. Seller reserves the right to designate additional Milestones where the Agreement provides for Services in excess of \$50,000.

**10. SOFTWARE AND FIRMWARE:** Notwithstanding any other provision herein to the contrary, Seller or applicable third party owner shall retain all rights of ownership and title in its respective firmware and software, including all copyrights relating to such firmware and software and all copies of such firmware and software. Except as otherwise provided herein, Buyer is hereby granted a nonexclusive, royalty free license to use firmware and software, and copies of firmware and software, incorporated into the Goods only in conjunction with such Goods and only at the Buyer's plant site where the Goods are first used. Buyer may negotiate with Seller separate licenses to use such copies and firmware and software at other plant sites. Buyer's use of certain firmwares (as specified by Seller) and all other software shall be governed exclusively by Seller's and/or third party owner's applicable license terms.

**11. BUYER SUPPLIED DATA:** To the extent that Seller has relied upon any specifications, information, representation of operating conditions or other

data or information supplied by Buyer to Seller ("Data") in the selection or design of the Goods and/or provision of the Services and the preparation of Seller's quotation, and in the event that actual operating conditions or other conditions differ from those represented by Buyer and relied upon by Seller, any warranties or other provisions contained herein which are affected by such conditions shall be null and void.

**12. EXPORT/IMPORT:** Buyer agrees that all applicable import and export control laws, regulations, orders and requirements, including without limitation those of the United States and the European Union, and the jurisdictions in which the Seller and Buyer are established or from which items may be supplied will apply to its receipt and use of Goods and Services. In no event shall Buyer use, transfer, release, import, export, or re-export Goods in violation of such applicable laws, regulations, orders, or requirements.

**13. GENERAL PROVISIONS:** (a) Buyer shall not assign its rights or obligations under the Agreement without Seller's prior written consent; (b) there are no understandings, agreements or representations, express or implied, not specified in the Agreement; (c) no action, regardless of form, arising out of transactions under the Agreement, may be brought by either party more than two years after the cause of action has accrued; (d) any modification of these terms and conditions must be set forth in a written instrument signed by a duly authorized representative of Seller; (e) the Agreement is formed and shall be construed, performed and enforced under the laws of the State of Missouri (however, Buyer and Seller agree that the proper venue for all actions arising under the Agreement shall be only in the State where the Goods involved in such actions were manufactured; (f) The 1980 United Nations Convention on Contracts for the International Sale of Goods does not apply to this Agreement; (g) If any provision of the Agreement is invalid under any statute or rule of law, such provision, to that extent only, shall be deemed to be omitted without affecting the validity of the remainder of the Agreement; (h) Seller specifically objects to the application of any Federal Acquisition Regulation ("FAR") or other governmental procurement provision or clause to the Agreement; (i) UNLESS OTHERWISE SPECIFICALLY PROVIDED IN SELLER'S QUOTATION, GOODS AND SERVICES HEREUNDER ARE NOT INTENDED FOR USE IN ANY NUCLEAR OR NUCLEAR RELATED APPLICATIONS. Buyer (i) accepts Goods and Services in accordance with the restriction set forth in the immediately preceding sentence, (ii) agrees to communicate such restriction in writing to any and all subsequent purchasers or users and (iii) agrees to defend, indemnify and hold harmless Seller from any and all claims, losses, liabilities, suits, judgments and damages, including incidental and consequential damages, arising from use of Goods and Services in any nuclear or nuclear related applications, whether the cause of action be based in tort, contract or otherwise, including allegations that the Seller's liability is based on negligence or strict liability; (j) The rights, remedies and protections afforded to Seller under this Agreement, including but not limited to indemnification of Seller, limitation of remedy and liability and limited warranty shall extend to Seller and to its affiliates, subsidiaries, or related companies performing or supplying work, services, or products under this Agreement or any agreement into which it is incorporated by reference; and (k) Seller does not agree to: (i) indemnify Buyer; or (ii) name Buyer as an additional insured.

### SPDT, FORM C

SubSea - 4 Pin - Lock Sleeve	
Pin 1	COM (Black)
Pin 2	N/O (White)
Pin 3	N/C (Red)
Pin 4	GND (Green)

#### Termination 4DD

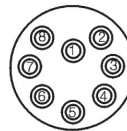
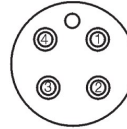

#### Termination 8DD

### DPDT, TWO FORM C

PVC Leads, Cable & Hi-Temp Teflon Leads	
N/C1 - Red	N/C2 - Red/White Stripe
N/O1 - Blue	N/O2 - Blue/White Stripe
COM1 - Black	COM2 - Black/White Stripe
GND - Green	

#### Termination A & F

### DPDT, TWO FORM C

Mini-Change QDC - 7 Pin	
Pin 1	N/O 2 - Black/White
Pin 2	COM 1 - Black
Pin 3	N/C 2 - White
Pin 4	N/C 1 - Red
Pin 5	COM 2 - Orange
Pin 6	N/O 1 - Blue
Pin 7	GND - Green

#### Termination DCH



Visit [www.topworx.com](http://www.topworx.com) for comprehensive information on our company, capabilities, and products – including model numbers, data sheets, specifications, dimensions, and certifications.

[info@topworx.com](mailto:info@topworx.com)

[www.topworx.com](http://www.topworx.com)

The Emerson logo is a trademark and service mark of Emerson Electric Co. ©2014 Emerson Electric Co. ©2014 TopWorx. All rights reserved. TopWorx, Valvetop, GO Switch, and Levelless Limit Switch are all trademarks of TopWorx. All other marks are the property of their respective owners. Information herein – including product specifications – is subject to change without notice.

### GLOBAL SUPPORT OFFICES

**Americas**  
TopWorx  
3300 Fern Valley Road  
Louisville, Kentucky 40213  
USA  
+1 502 969 8000

**Europe**  
Horsfield Way  
Bredbury Industrial Estate  
Stockport SK6 2SU  
United Kingdom  
+44 0 161 406 5155

**Asia-Pacific**  
1 Pandan Crescent  
Singapore 128461  
+65 6891 7550

**Middle East**  
P.O. Box 17033  
Jebel Ali Free Zone  
Dubai 17033  
United Arab Emirates  
+971 4 811 8283

**Africa**  
24 Angus Crescent  
Longmeadow Business Estate  
East  
Modderfontein  
Gauteng  
South Africa  
+27 011 451 3700