

RGASKETX212 and RGASKETX472 -325 to 1100°F (-198 to 593°C)  
 RGASKETX362 -100 to 450°F (-73 to 232°C) for standard service; to 300°F (149°C) for temperature cycling service

For necessary information concerning the installation of this gasket kit, please consult the appropriate Fisher product instruction manual.

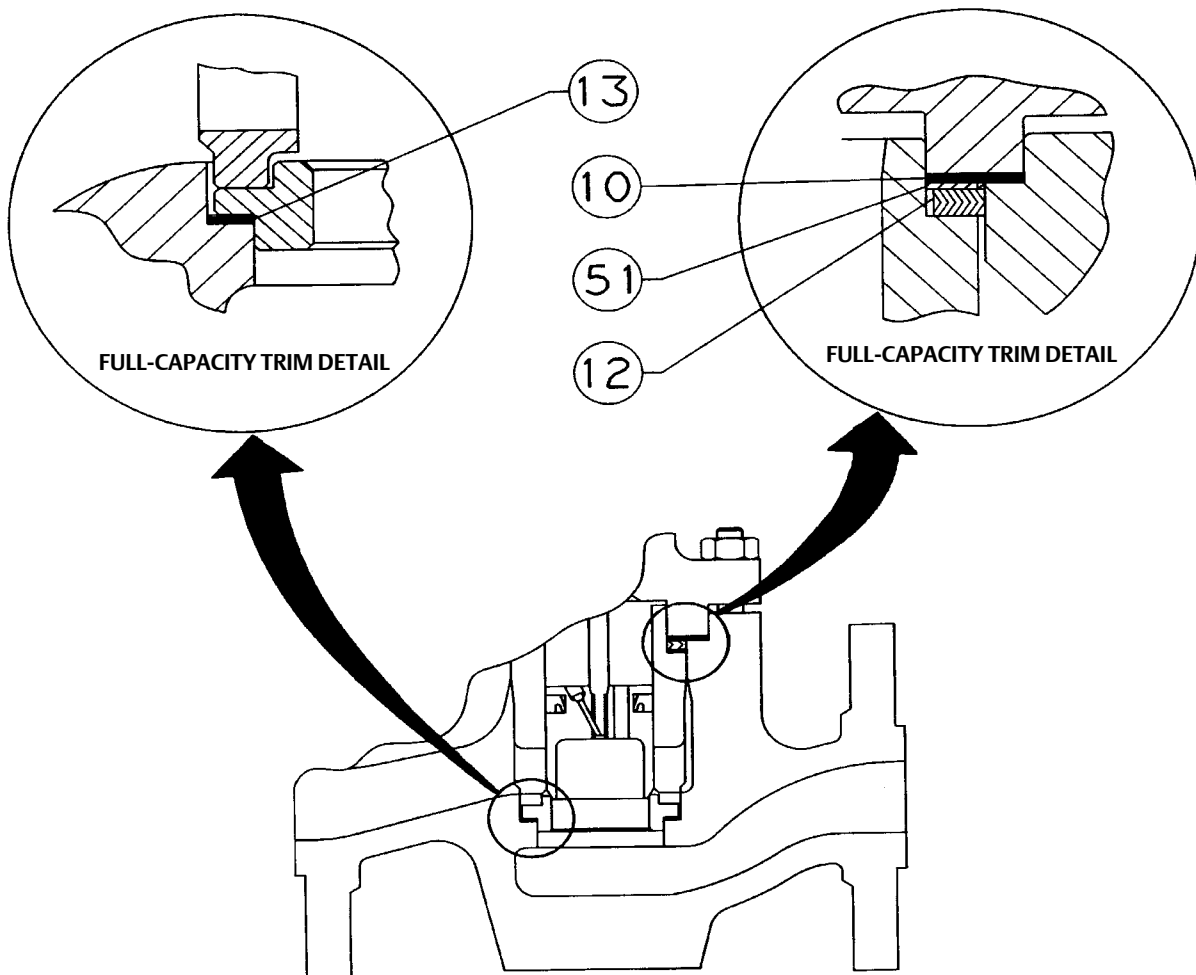

<u>Key No.</u>	<u>Part Name</u>	<u>Outside Diameter</u>
10	Bonnet Gasket	6.09 Inches
12	Spiral Gasket	5.56 Inches
13	Seat Ring Gasket	5.47 Inches
51	Shim	5.59 Inches

**Gasket Sizing Key**



**Neither Emerson, Emerson Process Management, nor any of their affiliated entities assumes responsibility for the selection, use or maintenance of any product. Responsibility for proper selection, use, and maintenance of any product remains solely with the purchaser and end user.**

Fisher is a mark owned by one of the companies in the Emerson Process Management business unit of Emerson Electric Co. Emerson Process Management, Emerson, and the Emerson logo are trademarks and service marks of Emerson Electric Co. All other marks are the property of their respective owners.

The contents of this publication are presented for informational purposes only, and while every effort has been made to ensure their accuracy, they are not to be construed as warranties or guarantees, express or implied, regarding the products or services described herein or their use or applicability. All sales are governed by our terms and conditions, which are available upon request. We reserve the right to modify or improve the designs or specifications of such products at any time without notice.

**Emerson Process Management**

Marshalltown, Iowa 50158 USA

Sorocaba, 18087 Brazil

Chatham, Kent ME4 4QZ UK

Dubai, United Arab Emirates

Singapore 128461 Singapore

[www.Fisher.com](http://www.Fisher.com)

