



**Ultraviolet
Flame Detector
User Manual**

**Model:
UVS-A-X OR AR-X**



ISO 9001:2000



IMPORTANT INFORMATION

This manual is for informational purposes only. Although every effort has been made to ensure the correctness of the information, technical inaccuracies may occur and periodic changes may be made without notice. Net Safety Monitoring Inc., assumes no responsibility for any errors contained within this manual.

If the products or procedures are used for purposes other than as described in the manual, without receiving prior confirmation of validity or suitability, Net Safety Monitoring Inc., does not guarantee the results and assumes no obligation or liability.

Complete instructions have been provided for the safe service, use, installation, configuration and maintenance of this product in compliance with EN 60079-14 and EN 60079-10 for hazardous locations. Ensure this manual is read thoroughly before installation or operation.

No part of this manual may be copied, disseminated or distributed without the express written consent of Net Safety Monitoring Inc.

Net Safety Monitoring Inc., products are carefully designed and manufactured from high quality components and can be expected to provide many years of trouble free service. Each product is thoroughly tested, inspected and calibrated prior to shipment. Failures can occur which are beyond the control of the manufacturer. Failures can be minimized by adhering to the operating and maintenance instructions herein. Where the absolute greatest of reliability is required, redundancy should be designed into the system.

Warranty

Net Safety Monitoring Inc., warrants its sensors against defective parts and workmanship for a period of 24 months from date of purchase; other electronic assemblies for 36 months from date of purchase.

No other warranties or liability, expressed or implied, will be honoured by Net Safety Monitoring Inc.

Contact Net Safety Monitoring Inc., or an authorized representative for details.

We welcome your input at Net Safety Monitoring. If you have any comments please contact us at the phone/address below or visit our web site and complete our on-line customer survey: www.net-safety.com.

Contact Information

Net Safety Monitoring Inc.
2721 Hopewell Place NE
Calgary, AB
Canada
T1Y 7J7
Telephone: (403) 219-0688 Fax: (403) 219a-0694
www.net-safety.com
E-mail: nsmsales@net-safety.com

Copyright © 2007 Net Safety Monitoring Inc.
Printed in Canada

TABLE OF CONTENTS

Important Information	3	Testing	16
Warranty	3	Manual Check Procedure	16
Contact Information	3	Automatic Visual Integrity (VI) Test	16
Introduction	5	Manual VI Test	16
Spectral Sensitivity Range	5	Test Procedure	17
Locate Detector	5	Cleaning Window/Lens and Reflector	18
Typical applications	5	O-ring	18
Potential ignition sources	5	Troubleshoot	20
Potential inhibitors	5	Appendix A: Common UV Absorbing Gases	21
Absorbing Gases	6	Appendix B: Electrostatic Sensitive Device (ESD)	22
Range	6	Appendix C: Resistance Table	23
Field of View (as per FM and NFPA definition)	6	Appendix D: Specifications	24
Installation Considerations	7	Appendix E: UVS DATA (continued)	26
Unpack	7		
Reflector Positioning	9		
Field Installation	9		
Wiring	10		
Grounding	10		
Sealing	10		
Connecting	10		
Detector Setup	12		
System Sensitivity	12		
DIP Switch Access	12		
Sensitivity Setting	12		
Time Delay Setting	12		
Closing the Housing	13		
Relay Settings	13		
Coil and Latch Status	13		
Remote Reset	13		
Final Setup	13		
Detector Functionality	14		
Detector Window/Lens	14		
Start Up Procedure	14		
System Check	14		
Monitor	14		
Condition Status—LEDs	14		
Condition Status—Current Output	15		
Detector Maintenance	16		

INTRODUCTION

The UVS is a smart, stand-alone fire detector. The detector is designed to respond to UV radiation emitted by a wide range of fires including hydrocarbon, hydrogen and metal based fires. The UVS is ideal for a variety of applications and has been proven reliable in even the most extreme environments.

Spectral Sensitivity Range

The UVS fire detector responds to UV radiation wavelengths of 185 to 260 nanometres (1850 to 2600 angstroms). Note that UV radiation reaching the earth from the sun does not extend into the sensitivity range of the detector, nor does radiation from normal artificial lighting, such as fluorescent, mercury vapour and incandescent lamps.

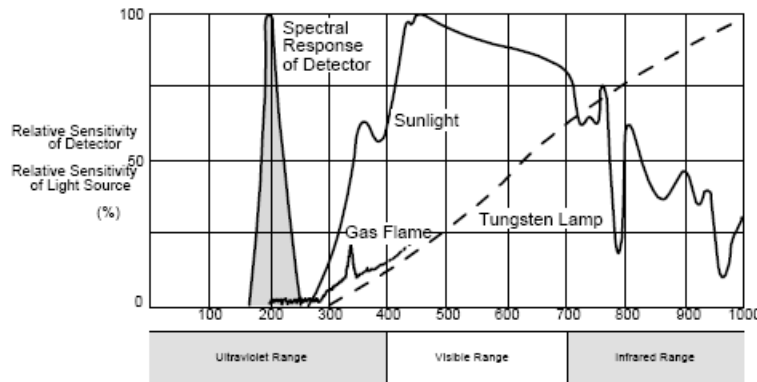

Locate Detector

When positioning fire detectors, consider such factors as distance from the fire, type of fuel and temperature, as well as any environmental factors which may influence the detector's response to radiation.

Typical applications

- automotive-manufacturing and paint spray booths
- aircraft hangars (commercial and military)
- offshore platforms, refineries, pipelines and production ships
- printing industry facilities
- oil, gas and petrochemical refineries/production/storage/off loading/shipping
- various production, processing and storage facilities
- munitions handling
- warehouses (flammable liquids/toxic gases) and tank farms (floating/non-floating)
- power generation pumps, generators and unmanned stations

Potential ignition sources

A hydrocarbon fuel-based fire can erupt in areas where the following are found:

- alcohol
- gasoline
- paint
- aviation fuel
- acetylene
- natural gas
- solvents
- heptane/naptha
- diesel and hydraulic fuel
- liquefied natural gas (LNG)
- liquefied petroleum gas (LPG)
- propane/methane/butane

Potential inhibitors

A potential inhibitor is anything located between the detector and a potential fire source which could prevent the UVS from detecting a fire or reduce its sensitivity to fire. Possible inhibitors include but are not limited to the following:

- Solid objects such as machinery, glass or plexiglass between the detector and potential fire source
- Water, fog, rain, dirt or dust on the detector window or heavy smoke between the detector and potential fire source

Absorbing Gases

A further potential inhibitor may be the presence of UV absorbing gases or chemical vapours between the detector and source of potential fire. Such gases could impede the detector’s ability to detect a UV flame source. Small concentrations of these gases may not be sufficient to obstruct the sensor but high concentrations may impede the UV sensor. Moving the detectors closer to the probable fire source and increasing the sensitivity can, in some circumstances, overcome this issue (refer to Appendix A).

RANGE

The practical application distance is directly related to the intensity of the ultraviolet radiation source.

Table 1: Response Testing

Response Testing			
Fuel	Size	Distance (ft/m)	Average Response Time (Seconds)
n-Heptane	1' x 1'	150/45.7	8.5
Methanol	1' x 1'	40/12.2	5.36
Methane	36" Plume	120/36.6	3.1
	16" Plume		
Propane	16" Plume	60/18.3	4.0
Jet Fuel	1' x 1'	90/27.4	2.2
Diesel	1' x 1'	90/27.4	3.9
Lube Oil	1' x 1'	50/15.2	2.1
Ethanol	1' x 1'	60/18.3	2.0
Gasoline	1' x 1'	120/36.6	2.8

NOTE: The response time is based on zero time delay and maximum sensitivity.

Field of View (as per FM and NFPA definition)

The area in front of a flame detector, where a standardized flame can be detected and which is specified by distance and angle off the central axis, is the Field of View. The referenced flame is moved to 50% of the maximum on-axis detection distance and then moved off-axis horizontally and vertically to the limit of detection. These off-axis angle limits specify Field of View.

Table 2: Field of View Testing

Field of View Testing			
Fuel	Size	Horizontal Degrees	Vertical Degrees
n-Heptane	1' x 1'	120 (+60, -60)	95 (+35, -60)
Methanol	1' x 1'	120 (+60, -60)	105 (+45, -60)
Methane	30" Plume	120 (+60, -60)	95 (+35, -60)
	16" Plume		
Propane	16" Plume	60 (+30, -30)	60 (+30, -30)
Jet Fuel	1' x 1'	120 (+60, -60)	95 (+35, -60)
Diesel	1' x 1'	120 (+60, -60)	95 (+35, -60)
Lube Oil	1' x 1'	120 (+60, -60)	95 (+35, -60)
Ethanol	1' x 1'	60 (+30, -30)	60 (+30, -30)
Gasoline	1' x 1'	120 (+60, -60)	95 (+35, -60)

NOTE: Data based on Maximum Sensitivity Setting.

Installation Considerations

- The following should be considered when mounting flame detectors.
- Point detector toward where the flame is expected.
- Ensure an unobstructed view of the area to be monitored.
- Employ more than one detector to ensure the hazard is fully covered.
- Mount the detector a few feet (about 1 metre) below the ceiling so it can respond before being blocked by smoke accumulation at the ceiling.
- If dense smoke is likely to accumulate prior to flame (as in an electrical fire), supplement UVS detector(s) with other protection such as Net Safety Monitoring Airborne Particle Monitor.
- The detector should be accessible for cleaning the window and reflector surfaces.
- Tilt detector downward a minimum of 10 to 20° to reduce dirt and dust accumulation which could obscure the detector's viewing window.
- Securely mount detector so as to reduce vibration as much as possible.
- When located outside, detector sensitivity can be reduced by heavy fog, rain and/or ice.
- Consider shortening the time delay settings when smoke is expected to accumulate before or during a fire (refer to "System Sensitivity").
- Reduce sensitivity setting if false alarms, related to surrounding activities, occur (refer to "System Sensitivity")
- When installed near or on water (such as an off shore platform), be sure to take into account the low horizon level when tilting detector downward.
- UV fire detectors respond to radiation other than ultraviolet such as X-rays which can activate the detector. Since X- rays are often used in

industrial inspection it may be necessary to disable the system when inspections are conducted nearby.

- External sources of UV such as arc welding, x-ray or lightning can produce alarm.
- For protection against line surge and extraneous transients, it is required to install detector wires in a braided flexible conduit less than 5 feet.

UNPACK

Carefully remove all components from the packaging. Check components against the enclosed packing list and inspect all components for obvious damage such as broken or loose parts.

If you find any components missing or damaged, notify the representative or Net Safety Monitoring immediately.

Figure 1: Detector Housing and Swivel Mount

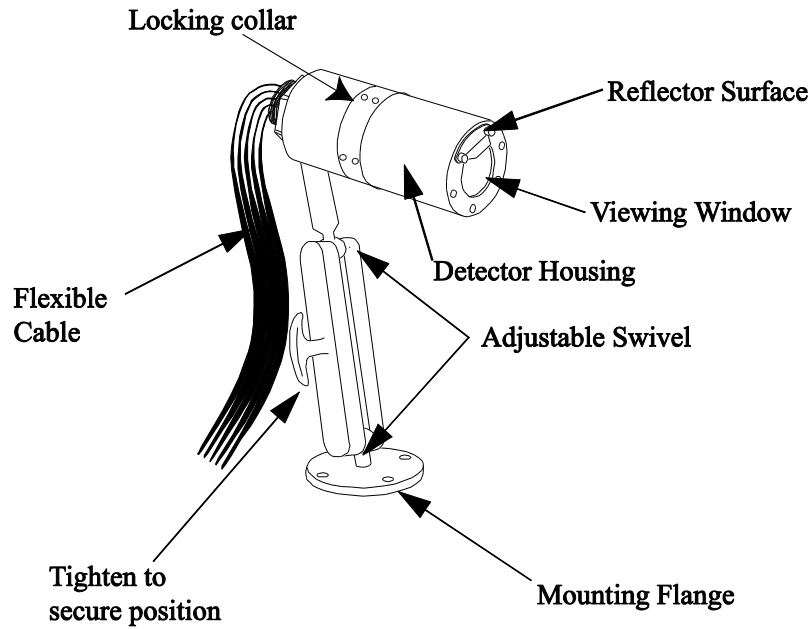

UVS-A or AR

Note: Units are factory sealed.

Figure 2: Dimensional Drawing

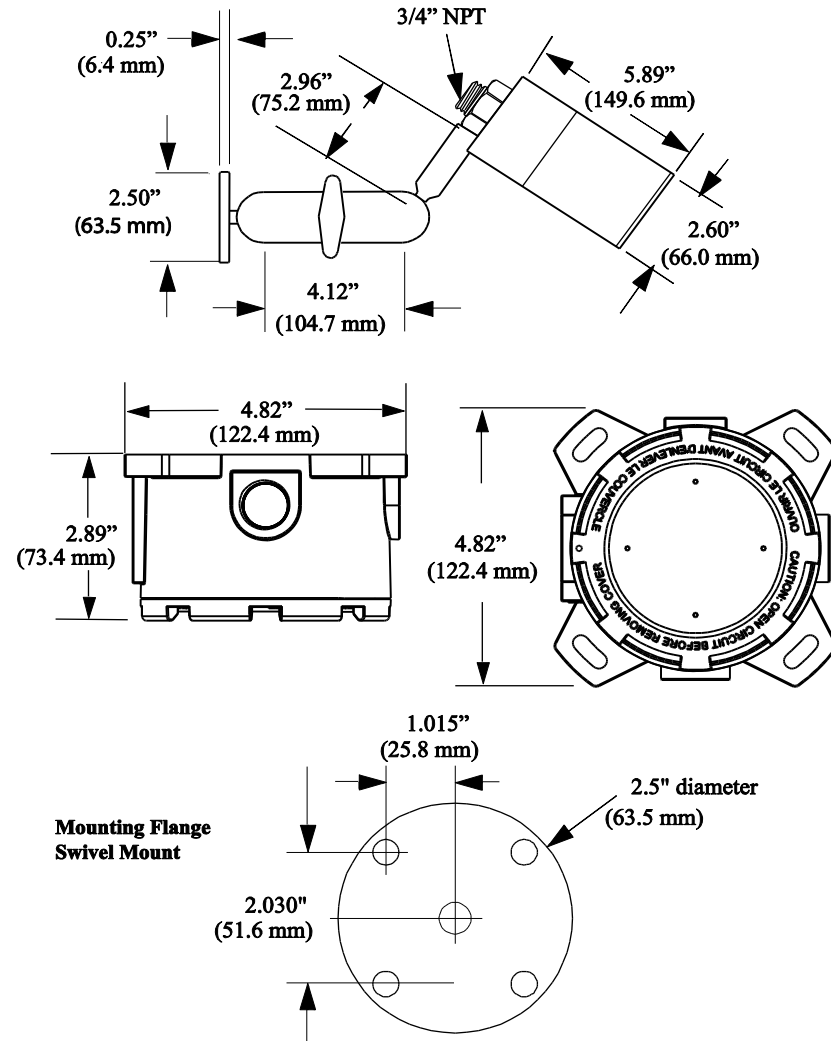

Reflector Positioning

Ensure the external VI reflector is placed directly over the VI Emitters (refer to Figure 7 for VI source location). Also ensure the detector is mounted with the VI reflector in the top position, centred over the yellow dot.

Figure 3: Position of VI Reflector

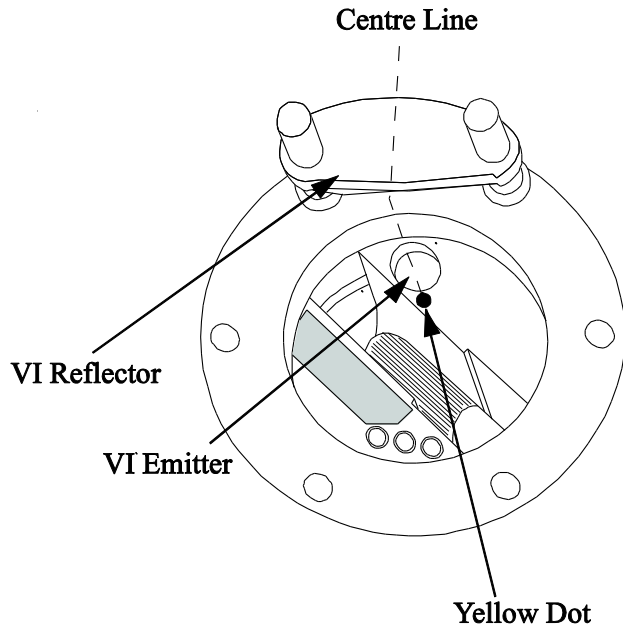

FIELD INSTALLATION

WARNING: 

- Wiring codes and regulations may vary. Compliance with regulations is the responsibility of the installer. Wiring must comply with applicable regulations relating to the installation of electrical equipment in a hazardous area. If in doubt, consult a qualified official before wiring the system.
- This equipment is only suitable for ATEX Category 2 (Zone 1) locations.
- Equipment must be installed in compliance with EN 60079-14.
- The permanently connected cable need appropriate protection of the free end of the cable. Use an ATEX certified Junction Box.
- Do not open housing and expose electronics in a classified area. (Do not open when an explosive atmosphere may be present)
- Ensure area is de-classified prior to opening housing.
- The parts of the bushing outside the flameproof enclosure have to be protected from mechanical impact by means of Ex components (e.g. Enclosure, Thread adapters, Conduit)

WIRING

For protection against line and extraneous transients, it is required to install detector pig tail lead wires in a braided flexible conduit less than 5 feet in length to the termination box. From the termination box to the power supply the recommended detector cable is four conductor (or greater), shielded 18 AWG rated 300 V for distances up to 150 feet. When cable is installed in conduit, the conduit must not be used to support wiring to any other electrical equipment. Detectors can be located over 150 feet and up to 2000 feet if 16 AWG shielded conductor is used. The maximum distance between the detector and the power supply is limited by the resistance of the connecting wiring, which is a function of the gauge of the wire being used. Refer to “Appendix C, Resistance Table (Ohms)”. The unterminated wires must be terminated in a suitable certified ATEX enclosure or fitting.

Grounding

An external ground is required. The flame detector must also be connected to an ATEX certified junction Box to ensure adherence to safety conditions. If the junction box is non-metallic, the external ground must be provided by some other means.

SEALING

Water-proof and explosion-proof conduit seals are recommended to prevent the accumulation of moisture within the junction box. Seals should be located as close to the device as possible and not more than 18 inches (46 cm) away. Explosion-proof installations may require an additional seal where conduit enters a non-hazardous area. When pouring a seal, use a fibre dam to ensure proper formation of the seal. Seals should never be poured at temperatures below freezing.

The jacket and shielding of the cable should be stripped back to permit the seal to form around the individual wires. This will prevent air, gas and water leakage through the inside of the shield and into the enclosure.

It is recommended that explosion-proof drains and conduit breathers be used. Changes in temperature and barometric pressure can cause 'breathing' which allows moist air to enter conduit. Joints are seldom enough to prevent 'breathing'.

CONNECTING

There are two configurations of the UVS available: Analog (A) and Analog with Relays (AR). Review the following figures for wiring and other settings specific to the A or AR board configurations.

WARNING:  Prior to wiring, ensure power is disconnected. Improper wiring can cause damage to the detector.

Figure 4: Wire Colour Coding — ANALOG

FLAME DETECTOR WIRE CODING	
Wire Colour	Function
Green	Earth Ground (GND)
Blue	Manual VI (MVI)
White	Vdc (+)
Black	Com (-)
Red	4-20mA Signal Output

WARNING:  For Analog models, if terminations are being done in a Net Safety Multi-Purpose Junction Box, refer to MAN-0081 for specific terminal designations.

Figure 5: Junction Box Connection — ANALOG/RELAY BOARD

Relay Contacts	
NO	Normally Open
NC	Normally Closed
COM	Common

FIELD WIRING	
Terminal	Function
RRst	Remote Reset
MVI	Manual VI
SIG	4-20mA Signal Output
-PWR	Com (-)
+PWR	Vdc (+)

Note: Terminate shield of field wiring at one end only to Earth Ground.

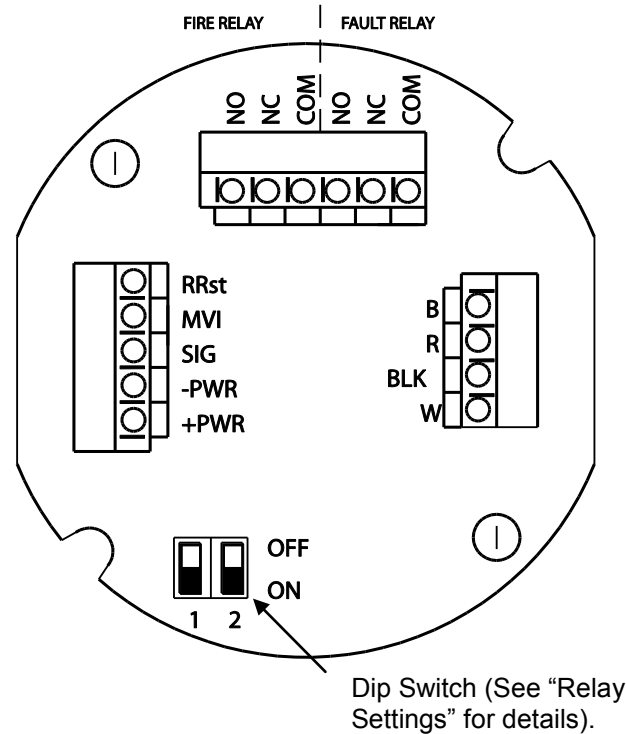

FLAME DETECTOR WIRING		
Terminal	Wire	Function
B	Blue	Manual VI / Communication
R	Red	4-20mA Signal Output
BLK	Black	Com (-)
W	White	Vdc (+)
	Green	Earth Ground (GND)

Note: Connect Green Wire (Earth GND) to ground lug of housing.

WARNING:  If the 4-20mA signal is not used, connect a jumper between the terminals for 4-20mA signal output (SIG) and -PWR (Com-) on the Field Wiring terminal block.

DETECTOR SETUP

SYSTEM SENSITIVITY

The UVS fire detector can be adjusted to various sensitivity levels by setting the detector to respond at a predetermined detector count rate. The count rate is dependent upon the intensity of the ultraviolet radiation reaching the detector, which in turn depends on the type of fuel, temperature, flame size and distance of flame from the detector.

DIP Switch Access

DIP Switches are used to set the detector's sensitivity and time delay settings. The DIP Switches are located on the internal Sensor module of the UVS.

WARNING:  Do not open the fire head in a classified area. The area must be de-classified prior to opening the fire head. . This detector is ATEX approved and has a locking collar that requires a 2mm Hex key to open

WARNING:  Do not touch internal components other than the DIP Switches (see Appendix B, " Electrostatic Sensitive Device (ESD) ")

To access and select Dip switches, follow the steps below:

1. Unscrew Locking Sleeve Collar's 6 set screws and slide it off the housing.
2. Unscrew the Housing Top counter clockwise.
3. Slide a DIP Switch to the ON or OFF position. Refer to Figure 6 and Table 3 for instructions.

Figure 6: DIP Switch Location

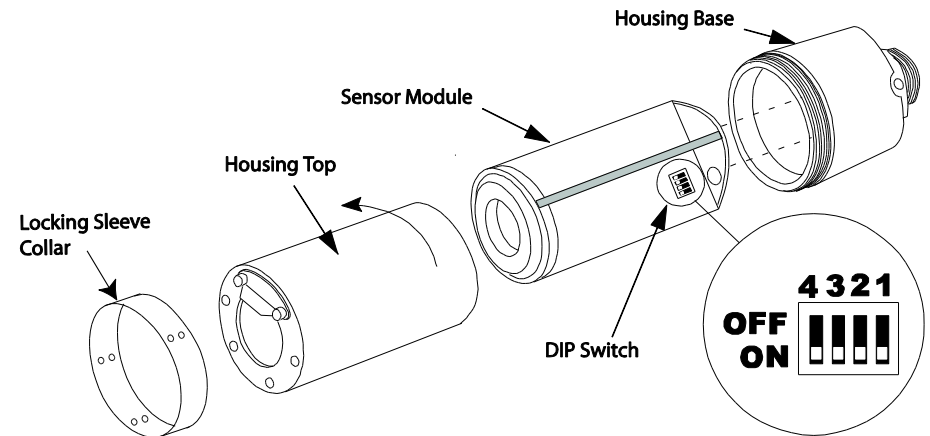

Sensitivity Setting

The adjustable Sensitivity setting is used to optimize the UVS for various installations. When selecting a Sensitivity setting, consider the following points:

- Size of potential fire
- Distance between possible fire and detector
- Type of flammable substance to be detected
- Environmental factors

Time Delay Setting

Defining the Time Delay allows the Fire alarm signal to delay (for the specified time), before indicating an alarm. This feature can be beneficial depending upon the conditions/activities surrounding the detector.

Table 3: Sensitivity and Time Delay Settings (Sensor Module)

Sensitivity			Time Delay		
	Position 1	Position 2		Position 3	Position 4
8CPS	ON	ON	0 secs	ON	ON
16 CPS	ON	OFF	3 secs	ON	OFF
24 CPS	OFF	ON	5 secs	OFF	ON
32 CPS	OFF	OFF	7 secs	OFF	OFF

Note: Default settings are set for Maximum Sensitivity of 8 Counts Per Second (CPS) and a 3 second Time Delay.

Closing the Housing

When closing the Housing Cover, be sure that the top and bottom are screwed together tightly.

TIP: It is extremely important that the VI reflector is centred over the yellow dot. Refer to Figure 3 or Figure 7.

RELAY SETTINGS

Coil and Latch Status

The Junction Box (Relay only) has a two-position DIP Switch to define the Coil and Latch Status for the Fire Relay. Refer to Figure 5, "Junction Box Connection – Analog/Relay Board" for DIP Switch location.

Note: The default Fire Relay is normally De-energized/Non-Latching. The Fault Relay is factory set to normally Energized/Non-latching and cannot be modified.

Table 4: Relay Setting (Junction Box)

Coil and Latch Status		
Fire Relay	Position 1	Position 2
De-energized / Non-latching	ON	ON
Energized / Non-latching	ON	OFF
De-energized / Latching	OFF	ON
Energized / Latching	OFF	OFF

Remote Reset

If the alarm is setup for latching status, then it can be reset by momentarily connecting RRST (Remote Reset) to –PWR in the Junction Box (Relay only). Refer to Figure 5 and Table 4.

Final Setup

- Ensure all internal settings complete
- Securely close Housing
- Ensure reflector positioned over the Yellow Dot.
- Clean detector lens
- Mount and align detector

DETECTOR FUNCTIONALITY

DETECTOR WINDOW/LENS

Figure 7: Detector Viewing Windows

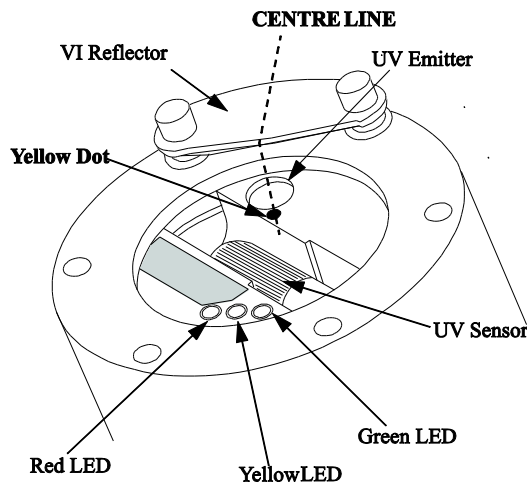

Note: An optional heater is available to eliminate condensation on the glass window/lens.

START UP PROCEDURE

Once powered up, the UVS will begin a 90 second start up routine. During this time, the current output will be 3 mA .The UV source light and the Green power LED will be on. Once the start up procedure has finished, and no faults are present, the detector will begin Normal operation (current output 4 mA and Green LED will remain on).

System Check

Once powered up, the system should be checked. Refer to the section entitled "Manual Check Procedure " for instructions.

WARNING: ⚠ When testing the system, ensure all external equipment is disabled to prevent unwanted alarm activation. Enable external equipment once testing is completed.

MONITOR

The Detector's status can be determined by monitoring the current loop and/or the condition LEDs.

Condition Status—LEDs

There are three (3) LEDs used to indicate the status of the detector (refer to Table 5: Status LEDs and Current Output).

Condition Status—Current Output

The Current Loop status can also be measured to determine detector condition.

Test Jacks are available on the Analog version connector board in the Net Safety Multi-Purpose Junction Box. Refer to MAN-0081 for details. The area must be de-classified prior to opening the Junction Box. The detector can also be monitored using the 4-20 mA Signal Output

Table 5: Status LEDs and Current Output

LED Status	Current O/P	Green LED (PWR)	Red LED (Alarm)	Yellow LED (Fault)
Internal power Fault or system power out of range	1mA	OFF		Solid
Automatic or manual VI Test Failure	2mA	OFF	OFF	Flashing
Power up – 90 secs start delay	3mA	Solid	OFF	OFF
Normal Operation	4mA	Solid	OFF	OFF
Background UV Source	6mA	Solid	OFF	OFF
Manual VI Testing Adequate	10mA	Solid	Solid	OFF
Manual VI Testing Good	11mA	Solid	Solid	OFF
Manual VI Testing Excellent	12mA	Solid	Solid	OFF
Early Warning – Intermittent UV detected	16mA	Solid	OFF	OFF
Fire Confirmed	20mA	OFF	Flashing	OFF

DETECTOR MAINTENANCE

Although an automatic testing of the optics is done every 90 seconds, the system should be periodically checked. To maintain maximum sensitivity, the viewing window/lens and reflector should be cleaned on a routine basis depending on the type and amount of contaminants in the area.

TESTING

WARNING:  When testing the system, ensure all external equipment is disabled to prevent unwanted alarm activation.

Manual Check Procedure

The whole system should be checked periodically with a Net Safety UV test lamp to make sure that the detectors are not obstructed, that the area covered by the detector has not changed and that there is no fault in the VI circuit

1. Activate and direct the UV Test lamp at the detector viewing window. The current output will change with the amount of radiation being detected and the Red LED will flash (refer to “ Table 5 - Status LEDs and Current Output”).
2. Turn off the UV Test lamp after a successful check.
3. Repeat steps 1 & 2 for all detectors in the system.
4. After all detectors have been checked, return the system to the normal operating mode and enable any external equipment.

Automatic Visual Integrity (VI) Test

The detector performs an automatic Visual Integrity (VI) test every 90 seconds during normal operation. If the lens is dirty, obstructed, or the reflector is dirty, obstructed or misaligned, the unit will perform a number of VI tests to confirm the presence of the obstruction.

If the obstruction is temporary, the unit will return to normal after the obstruction is removed. If the obstruction remains, the unit will drop the current output to 2 mA and the yellow LED will flash continuously indicating a misaligned reflector, failed sensor or contaminants on the window or reflector. The detector will remain in this condition until the problem is corrected. The detector window should be promptly cleaned (refer to "Cleaning window/Lens & reflector") or the obstruction removed. Also refer to the troubleshooting section – Possible Problems & Solutions.

Manual VI Test

This test procedure can assist with maintenance planning and is often performed during commissioning. The detector has a manual VI input and the manual VI test is performed by:

- connecting Manual VI to system power by a direct connection OR
- connecting a momentary contact push button between system power and the manual VI input.
- The Net Safety Junction Box is optional and is available with or without a Manual VI Test Switch (for Analog models). Activate the Manual VI Test Switch with the magnet if the switch is available, otherwise use other available options mentioned above for manual VI Test.

Note: The manual VI feature is optional. If not used, leave the M VI input disconnected or tied to system common.

The Manual VI test will return one of four current output responses depending upon the cleanliness of the detector window and reflector, the alignment of the reflector or the state of the sensor.

- Poor (2 mA) clean optical surfaces, align reflector
- Adequate (10 mA) clean optical surfaces, check reflector alignment
- Good (11 mA) optical surfaces moderately clean
- Excellent (12 mA) optical surfaces perfectly clean.

Test Procedure

1. Connect the manual VI test input terminal to system power by either a direct connection or manual push button. For Analog models, activate the Manual VI Test Switch if available inside the Net Safety Junction Box, with the external magnet provided. Otherwise use other Manual VI Test options previously mentioned.
2. Hold the manual VI input at this voltage for at least two seconds. The Red LED will be activated for the duration of the test.
3. The detector will output a current that corresponds to the quality of the VI reading obtained (see Table 5), after it performs a VI test reading.
4. Release the manual VI test input. The detector should immediately return to normal operation.
5. If a VI fault is present, the current output will indicate 2 mA and the Yellow LED will flash.

WARNING:  The detector will stay in the manual VI test mode as long as the manual VI input is held at the system power voltage. During the manual VI test all other detector functions are disabled. It is therefore imperative that after this test is performed the manual VI test input be released.

A visual integrity (VI) fault may be simulated by completely misaligning or removing the reflector, then putting the unit in MVI test mode. When this is done, the unit will go into fault indicated by the flashing yellow LED and a current output of 2 mA. Once the reflector is properly aligned (indicated in Figure 3 and Figure 7) and the unit taken out of MVI test mode, the unit will return to normal operation with a current output of 4 mA.

CLEANING WINDOW/LENS AND REFLECTOR

When cleaning the window and reflector use the cloth and the cleaning solution provided with the detector. Use only the provided cleaning solution as some cleaners can leave a residue.

To minimize dirt accumulation around the VI surface, a product such as Net Safety's Air Shield should be purchased to minimize particulate build up on the viewing window.

WARNING:  Always bypass Alarm Output when performing maintenance tasks and ensure all external equipment has been disconnected/deactivated.

O-ring

The rubber o-ring on the detector housing is used to ensure the detector is watertight. The housing should be opened periodically and the o-ring inspected for breaks, cracks or dryness. To test the o-ring, remove it from the detector housing and stretch it slightly. If cracks are visible, the o-ring should be replaced. If it feels dry to the touch, a thin coating of lubricant should be applied (such as polyalphaolefin grease). When re-installing the o-ring, be sure that it is properly seated in the groove on the housing.

The o-ring must be properly installed and in good condition to prevent water from entering the detector and causing failure. The life expectancy of rubber o-rings varies depending on the type and amount of contaminants present in the area. The person who maintains the system must rely on experience and common sense to determine how frequently the rings should be inspected. A coating of lubricant should also be applied to the enclosure threads before reassembling the detector to help prevent moisture from entering.

HOW TO RETURN EQUIPMENT

A Material Return Authorization number is required in order to return equipment. Please contact Net Safety Monitoring at **(403) 219-0688** before returning equipment or consult our Service Department to possibly avoid returning equipment.

If you are required to return equipment, include the following information:

1. A Material Return Authorization number (provided over the phone to you by Net Safety).
2. A detailed description of the problem. The more specific you are regarding the problem, the quicker our Service department can determine and correct the problem.
3. A company name, contact name and telephone number.
4. A Purchase Order, from your company, authorizing repairs or request for quote.
5. Ship all equipment, prepaid to:

Net Safety Monitoring Inc
2721 Hopewell Place NE
Calgary, Alberta, Canada
T1Y 7J7

6. Mark all packages: **RETURN for REPAIR**

Waybills, for shipments from outside Canada, must state:

Equipment being returned for repair.

All charges to be billed to the sender.

Also, please ensure a duplicate copy of the packing slip is enclosed inside the box indicating item 1-4 along with the courier and account number for returning the goods.

All Equipment must be Shipped prepaid. Collect shipments will not be accepted.

Pack items to protect them from damage and use anti-static bags or aluminium- backed cardboard as protection from electrostatic discharge.

TROUBLESHOOT

The occurrence of a false alarm may be due to various factors. In order to determine the source of a false alarm, keep accurate records including time, date, weather conditions, activities in area, etc. Consult the following table for possible solutions to false alarm conditions.

Table 6: Possible Problems and Solutions

False Alarm Condition				Possible Problem	Possible Solution
Current O/P	Green LED	Yellow LED	Red LED		
0 mA		Solid/ off		Shorted signal Output Loss of Power Loose Wire(s)	Check wiring. Check fuses (3 AMP fuse on bottom PCB) (any in-line power fuse) Check power source at unit
1 mA		Solid		Internal power fault System power out of range	Check power supply
2 mA		Flashing		VI (visual integrity) fault	Clean window (use Net Safety Monitoring Lens cleaner only). Check for obstruction(s) within Field of View. Check reflector position and alignment Check UV source bulb. If 4-20 output is not used, jumper it to negative PWR(Com-); close current loop.
6 mA	Solid			Background UV source	Confirm external UV source by covering detector window so it is blind to all radiation. - If signal goes away, background UV is present. Field of View should be cleared of UV sources/activities (i.e., cracked lenses on sodium/mercury vapour bulbs, welding, grinding, flare stacks, etc.); realign detector coverage area; redefine Time Delay; reset Sensitivity setting. If signal persists, electrical wiring or detector electronics may be at fault
10 mA	Solid		Solid	Manual VI test (adequate)	Clean all optical surfaces (use Net Safety Monitoring Lens cleaner only)
11 mA	Solid		Solid	Manual VI test (good)	No action required, optics are moderately clean
12 mA	Solid		Solid	Manual VI test (excellent)	No action required, all optical surfaces are perfectly clean

APPENDIX A: COMMON UV ABSORBING GASES

Since the UVS fire detectors are designed to detect fires by responding to the ultra-violet (UV) radiation they emit, it is very important to be aware of UV absorbing gases that may be present between the detector and the sources of potential fires. Small concentrations of these types of gases may not absorb enough UV radiation to cause a problem, but when higher concentrations of these gases are present the detectors may become blind as not enough ultra-violet radiation can reach them to activate an alarm. Moving detectors closer to the probable source of fire and increasing the sensitivity of the detector can help to overcome this problem in some cases. Following is a list of common UV absorbing gases:

<ul style="list-style-type: none"> • Acetaldehyde • Acetone • Acrylonitrile • Ethyl Acrylate • Methyl Acrylate • Ethanol • Ammonia • Aniline • Benzene • 1, 3 Butadiene • 2-Butanone • Butylamine • Chlorobenzene • 1-Chloro-1- Nitropropane • Chloroprene 	<ul style="list-style-type: none"> • Cumene • Cyclopentadiene • O-Dichlorobenzene • P-Dichlorobenzene • Methyl Methacrylate • Alpha-Methylstyrene • Naphthalene • Nitroethane • Nitrobenzene • Nitromethane • 1-Nitropropane • 2-Nitropropane • 2-Pentanone • Phenol • Phenyl Glycide Ether • Pyridine 	<ul style="list-style-type: none"> • Hydrogen Sulfide • Styrene • Tetrachloroethylene • Toluene • Trichloroethylene • Vinyl Toluene • Xylene
---	--	---

APPENDIX B: ELECTROSTATIC SENSITIVE DEVICE (ESD)

Electrostatic discharge (ESD) is the transfer, between bodies, of an electrostatic charge caused by direct contact or induced by an electrostatic field.

The most common cause of ESD is physical contact. Touching an object can cause a discharge of electrostatic energy—ESD! If the charge is sufficient and occurs near electronic components, it can damage or destroy those components.

In some cases, damage is instantaneous and an immediate malfunction occurs. However, symptoms are not always immediate—performance may be marginal or seemingly normal for an indefinite period of time, followed by a sudden failure.

To eliminate potential ESD damage, review the following guidelines:

- Handle boards by metal shields—taking care not to touch electronic components
- Wear grounded wrist or foot straps, or ESD shoes or heel grounders to dissipate unwanted static energy
- Prior to handling boards, dispel any charge in your body or equipment
- Ensure components are transported and stored in static safe packaging
- When returning boards, carefully package in the original carton and static protective wrapping
- Ensure ALL personnel are educated and trained in ESD Control Procedures

In general, exercise accepted and proven precautions normally observed when handling electrostatic sensitive devices.

A warning label is placed on the packaging, identifying product using electrostatic sensitive semiconductor devices.





APPENDIX C: RESISTANCE TABLE

Distance (Feet)	AWG #20	AWG #18	AWG #16	AWG #14	AWG #12	AWG #10	AWG #8
100	1.02	0.64	0.40	0.25	0.16	0.10	0.06
200	2.03	1.28	0.80	0.51	0.32	0.20	0.13
300	3.05	1.92	1.20	0.76	0.48	0.30	0.19
400	4.06	2.55	1.61	1.01	0.64	0.40	0.25
500	5.08	3.20	2.01	1.26	0.79	0.50	0.31
600	6.09	3.83	2.41	1.52	0.95	0.60	0.38
700	7.11	4.47	2.81	1.77	1.11	0.70	0.44
800	8.12	5.11	3.21	2.02	1.27	0.80	0.50
900	9.14	5.75	3.61	2.27	1.43	0.90	0.57
1000	10.20	6.39	4.02	2.53	1.59	1.09	0.63
1250	12.70	7.99	5.03	3.16	1.99	1.25	0.79
1500	15.20	9.58	6.02	3.79	2.38	1.50	0.94
1750	17.80	11.20	7.03	4.42	2.78	1.75	1.10
2000	20.30	12.80	8.03	5.05	3.18	2.00	1.26
2250	22.80	14.40	9.03	5.68	3.57	2.25	1.41
2500	25.40	16.00	10.00	6.31	3.97	2.50	1.57
3000	30.50	19.20	12.00	7.58	4.76	3.00	1.88
3500	35.50	22.40	14.10	8.84	5.56	3.50	2.21
4000	40.60	25.50	16.10	10.00	6.35	4.00	2.51
4500	45.70	28.70	18.10	11.40	7.15	4.50	2.82
5000	50.10	32.00	20.10	12.60	7.94	5.00	3.14
5500	55.80	35.10	22.10	13.91	8.73	5.50	3.46
6000	61.00	38.30	24.10	15.20	9.53	6.00	3.77
6500	66.00	41.50	26.10	16.40	10.30	6.50	4.08
7000	71.10	44.70	28.10	17.70	11.10	7.00	4.40
7500	76.10	47.90	30.10	19.00	12.00	7.49	4.71
8000	81.20	51.10	32.10	20.20	12.70	7.99	5.03
9000	91.40	57.50	36.10	22.70	14.30	8.99	5.65
10 000	102.00	63.90	40.20	25.30	15.90	9.99	6.28

Note: Resistance shown is one way. This figure should be doubled when determining closed loop resistance.

APPENDIX D: SPECIFICATIONS

Models:	UVS-A (Analog)	UVS-AR (Analog/Relay)
Operating Voltage	10 to 32 VDC	
Power Consumption	At 10Vdc: Nominal 95mA/ 0.95W. Max 225mA/ 2.25W *With Heater: Nominal 200mA/ 2.0W. Maximum 335mA/ 3.35W	At 10Vdc: Nominal 95mA/ 0.95W. Max 225mA/ 2.25W *With Heater: Nominal 200mA/ 2.0W. Maximum 335mA/ 3.35W
	At 24Vdc: Nominal 45mA/ 1.1W. Max 115mA/ 2.76W *With Heater: Nominal 90mA/ 2.16W. Maximum 165mA/ 3.96W	At 24Vdc: Nominal 45mA/ 1.1W. Max 95mA/ 2.28W *With Heater: Nominal 90mA/ 2.16W. Maximum 145mA/ 3.48W
	At 32Vdc: Nominal 35mA / 1.12W. Max 105mA/ 3.36W *With Heater: Nominal 70mA/ 2.24W. Maximum 140mA/ 4.48W	At 32Vdc: Nominal 35mA/ 1.12W. Max 80mA/ 2.56W *With Heater: Nominal 70mA/ 2.24W. Maximum 115mA/ 3.68W
In Rush Current	1.5A for 22ms	
Current Output	0 to 20 mA – Into a max loop impedance of 800Ohms @ 32Vdc or 150Ohms @ 11.0Vdc. Non-Isolated loop supply	
Relay Output	N/A	Form C contacts rated 1A @ 30Vdc, 0.5A @125Vac. Selectable energized/ de-energized, latching/ non-latching Fire relay. Fault relay fixed as energized/ non-latching
Field of View	120° Horizontal, 95° Vertical @ 50% of maximum on axis distance.	
Spectral Range	UV radiation over the range of 185 to 260 nanometres (1850 to 2600 angstroms)	
Time Delay	DIP switches selectable 0, 3, 5, 7 seconds.	
Sensitivity Settings	DIP switch selectable 8, 16, 24 or 32 counts per seconds	
Temperature & RH	FM Certified (-40°C to +75°C / -40°F to 167°F). Operational (-50°C to +75°C / -58°F to 167°F). 0 – 95% RH non condensing	
Metallurgy & IP/NEMA	Aluminum or SS316 (factory sealed housing). IP66 and NEMA 4X	
Weight (with swivel)	2.1Kg /4.5lbs (SS316 Option @ 3.4Kg/ 7.5lbs)	
Approvals	FM Performance certified to: Class3260, ANSI/NEMA 250, IEC60529.  0575  II2G, EEx d II B+H2 T5	

NOTE: Performance certified by FM with maximum sensitivity setting and zero second time delay

APPENDIX E: UVS DATA

False Alarm Immunity			
Fire Alarm Source	Distance (ft/m)	Modulated	Unmodulated
Sunlight direct	-----	No Alarm	No Alarm
Sunlight indirect	-----	No Alarm	No Alarm
1500 Watt heater	10/3.0	No Alarm	No Alarm
40 Watt Fluorescent Lights	10/3.0	No Alarm	No Alarm
500 Watt Halogen Light	3/0.9	No Alarm	No Alarm
250 Watt Incandescent Light	3/0.9	No Alarm	No Alarm
250 Watt Sodium Vapor Lamp	10/3.0	No Alarm	No Alarm
70 Watt Sodium Vapor Lamp	10/3.0	No Alarm	No Alarm
250 Watt Metal Halide Lamp	10/3.0	No Alarm	No Alarm
27,000 Watt Propane Heater	12/3.6	No Alarm	No Alarm

Response Testing w/ Un-modulated False Alarm Stimuli Present			
False Alarm Source	False Alarm Source Distance (ft/m)	Fire Source	Fire Source Distance (ft/m)
Sunlight direct	-----	16" Propane Plume	25/7.62
Sunlight indirect	-----	16" Propane Plume	25/7.62
1500 Watt heater	10/3.0	16" Propane Plume	25/7.62
40 Watt Fluorescent Lights	10/3.0	16" Propane Plume	25/7.62
500 Watt Halogen Light	3/0.9	16" Propane Plume	25/7.62
250 Watt Incandescent Light	3/0.9	16" Propane Plume	25/7.62
250 Watt Sodium Vapor Lamp	10/3.0	16" Propane Plume	25/7.62
70 Watt Sodium Vapor Lamp	10/3.0	16" Propane Plume	25/7.62
250 Watt Metal Halide Lamp	10/3.0	16" Propane Plume	25/7.62
27,000 Watt Propane Heater	12/3.6	16" Propane Plume	25/7.62

APPENDIX E: UVS DATA (CONTINUED)

Response Testing w/ Modulated False Alarm Stimuli Present			
False Alarm Source	Distance (ft/m)	Fire Source	Fire Source Distance (ft/m)
Sunlight direct	-----	16" Propane Plume	25/7.62
Sunlight indirect	-----	16" Propane Plume	25/7.62
1500 Watt heater	10/3.0	16" Propane Plume	25/7.62
40 Watt Fluorescent Lights	10/3.0	16" Propane Plume	25/7.62
500 Watt Halogen Light	3/0.9	16" Propane Plume	25/7.62
250 Watt Incandescent Light	3/0.9	16" Propane Plume	25/7.62
250 Watt Sodium Vapor Lamp	10/3.0	16" Propane Plume	25/7.62
70 Watt Sodium Vapor Lamp	10/3.0	16" Propane Plume	25/7.62
250 Watt Metal Halide Lamp	10/3.0	16" Propane Plume	25/7.62
27,000 Watt Propane Heater	12/3.6	16" Propane Plume	25/7.62

Net Safety Monitoring Inc.

2721 Hopewell Place NE, Calgary, AB Canada T1Y 7J7

1-866-FIREGAS (347-3427) | ph. (403) 219-0688 | fx. (403) 219-0694

<http://www.net-safety.com> | Email: nsmsales@net-safety.com

PRODUCT SERVICES CONTACT INFORMATION

Telephone [8am - 5pm MDT]: (403) 769-6074 | (403) 717-8219

Fax: (403) 219-0694 Email: productservices@net-safety.com

http://www.net-safety.com/service/product_services.html

