

Fisher™ 2506 and 2516 Receiver-Controllers

The 2506 receiver-controller takes the input from a pneumatic transmitter, matches it against the adjustable set point, and provides a proportional pneumatic output to a control valve actuator. The 2506 receiver-controller may be used in conjunction with a remote receiving indicator or recorder also using the output from the transmitter.

The 2516 receiver-controller has both proportional band and reset control. The reset adjustment efficiently brings the set point back to its original position.

Features

- **Easy Maintenance**—Simple design of the receiver-controller allows fast, easy maintenance and minimal spare parts inventory.
- **Easy Adjustment**—Proportional band and reset adjustment is accomplished quickly and without

special tools. The control set point is manually adjustable in the case or through remote air loading (figures 2 and 3).

- **Application Versatility**—Reset may be added to a receiver-controller originally furnished without it.
- **Mounting Versatility**—2506 and 2516 receiver-controllers may be attached to the casing or yoke of a control valve actuator, or placed anywhere between the transmitter and valve.
- **Stable Control**—A pressure balanced relay provides intermittent bleed and gives accurate, stable control. The addition of reset action on the 2516 unit offers drift compensation, yet provides smooth, stable control.
- **Easy Reversibility**—2506 and 2516 receiver-controllers may be changed from direct to reverse action, or vice-versa, by simply repositioning the reversing switch.



W4687

FISHER 2506 RECEIVER-CONTROLLER



W4688

FISHER 2516 RECEIVER-CONTROLLER

Specifications

Available Configurations

For additional information, refer to table 2
2506: A receiver-controller that is set for either proportional or snap action (S) control or is set for either direct or reverse (R) action
2516: A 2506 that also provides proportional-plus-reset control
2516F: A 2516 that also provides anti-reset windup control

Input Signal

■ 0.2 to 1.0 bar (3 to 15 psig) or ■ 0.4 to 2.0 bar (6 to 30 psig)

Output Signal⁽¹⁾

See table 1

Output Action

Direct Action: An increasing fluid, interface level, or density increases output pressure or,
Reverse Action: An increasing fluid, interface level, or density decreases output pressure

Remote Set Point Signal

From a control device, provide a remote set point signal that is 0.2 to 1.0 bar (3 to 15 psig) or 0.4 to 2.0 bar (6 to 30 psig) that matches the receiver-controller input signal range

Supply Pressure⁽²⁾

Normal Operating Pressure: See table 1
Maximum Pressure to Prevent Internal Part Rupture⁽¹⁾: 3.4 bar (50 psig)

Steady State Air Consumption

See figure 1

Proportional Band, Reset, and Anti-Reset Windup

See table 2

Performance

Hysteresis: 0.6 percent of output pressure change at 100 percent of proportional band, or differential gap

Standard Supply and Output Pressure Gauge Indications

See table 1

Standard Tubing Connections

1/4 NPT internal

Operative Ambient Temperature Limits⁽²⁾

Standard: -40 and 71°C (-40 and 160°F)
High Temperature: -18 and 104°C (0 and 220°F)

Hazardous Area Classification

2506/2516 receiver-controllers comply with the requirements of ATEX Group II Category 2 Gas and Dust

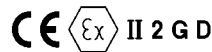

Meets Customs Union technical regulation TP TC 012/2011 for Groups II/III Category 2 equipment

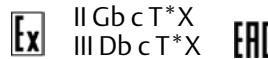

Construction Materials

Case and Cover: Die-cast aluminum
Flapper: K93600 nickel alloy
Bellows: ■ Bronze (standard) or ■ stainless steel (optional)
Nozzle: C36000 (Brass)
Proportional Band Valve Body, Seat, and Plug: Brass
Gaskets: ■ Chloroprene (standard) or ■ silicone (high temperature)
Relay Body: Aluminum/brass
Relay Valve Plug and Seats: Brass
Relay Diaphragm: ■ Nitrile (standard) or ■ polyacrylate (high temperature)
Reset Valve Body, if Used: Die-case zinc
Reset Valve Plug and Seat Ring, if Used: 18-8 stainless steel

Approximate Weight

4.53 kg (10 pounds)

Dimensions

Refer to figure 5

Options

■ Reverse action; ■ Instrument pressure gauge; ■ stainless steel bellows; Gauge markings in ■ bar, ■ kg/cm², ■ kPa, or ■ Psig/kPa; and ■ High temperature gasket and relay materials

NOTE: Specialized instrument terms are defined in ANSI/ISA Standard 51.1 - Process Instrument Terminology.
1. Either direct or reverse acting.
2. The pressure/temperature limits in this document and any other applicable standard or code limitation should not be exceeded.

Table 1. Supply Pressure Data

OUTPUT SIGNAL	STANDARD SUPPLY AND OUTPUT PRESSURE GAUGE INDICATIONS ⁽¹⁾	NORMAL OPERATING SUPPLY PRESSURE ⁽²⁾	
		Bar	Psig
0.2 to 1.0 bar (3 to 15 psig)	0 to 30 psig	1.5	20
0.4 to 2.0 bar (6 to 30 psig)	0 to 60 psig	2.4	35

1. Consult your [Emerson sales office](#) or Local Business Partner about gauges in other units.
2. Control and stability may be impaired if this pressure is exceeded.

Table 2. Additional Information

Control Mode ⁽¹⁾	Full Output Change Obtainable Over Output Of:	Output Signal
Proportional control (2506)	Proportional Band: Adjustable from 0 to 100% of transmitter signal.	0.2 to 1.0 bar (3 to 15 psig) or 0.4 to 2.0 bar (6 to 30 psig)
Snap action control (2506)	Snap Action: Control output is at 0 or 100% of input supply pressure. Switching depends on position of sensor and is adjustable.	0 to 1.4 bar (0 to 20 psig) or 0 to 2.4 bar (0 to 35 psig)
Proportional-plus-reset control (2516)	Proportional Band: Adjustable from 0 to 200% of transmitter signal. Recommended setting is from 20 to 200%. Reset: Adjustable from 0.01 to 74 minute per repeat with standard reset valve setting.	
Proportional-plus-reset with anti-reset windup (2516F)	Proportional Band: Adjustable from 0 to 200% of transmitter signal. Recommended setting is from 20 to 200%. Reset: Adjustable from 0.01 to 74 minute per repeat with standard reset valve setting. Anti-Reset Windup: Provides relief when output pressure falls or when output pressure rises depending on valve adjustment.	0.2 to 1.0 bar (3 to 15 psig) or 0.4 to 2.0 bar (6 to 30 psig)

1. Proportional control is continuously active between 0 and 100 percent of the transmitter signal span. Differential gap provides snap action between 0 and 100 percent of the transmitter signal. Do not use reset controllers in snap action.

Figure 1. Steady-State Air Consumption

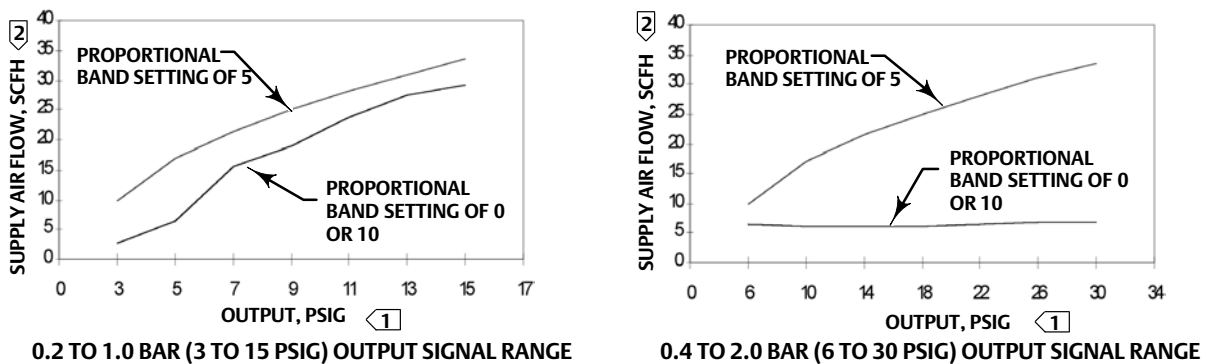

Notes
 ① To convert psig to bar, multiply by 0.06895.
 ② Scfh—standard cubic feet per hour (60°F and 14.7 psia). To convert to normal M³/hr—normal cubic metres per hour (0°C and 1.01325 bar, absolute), multiply by 0.0268
 A7242

Figure 2. Fisher 2506 Receiver-Controller Schematic

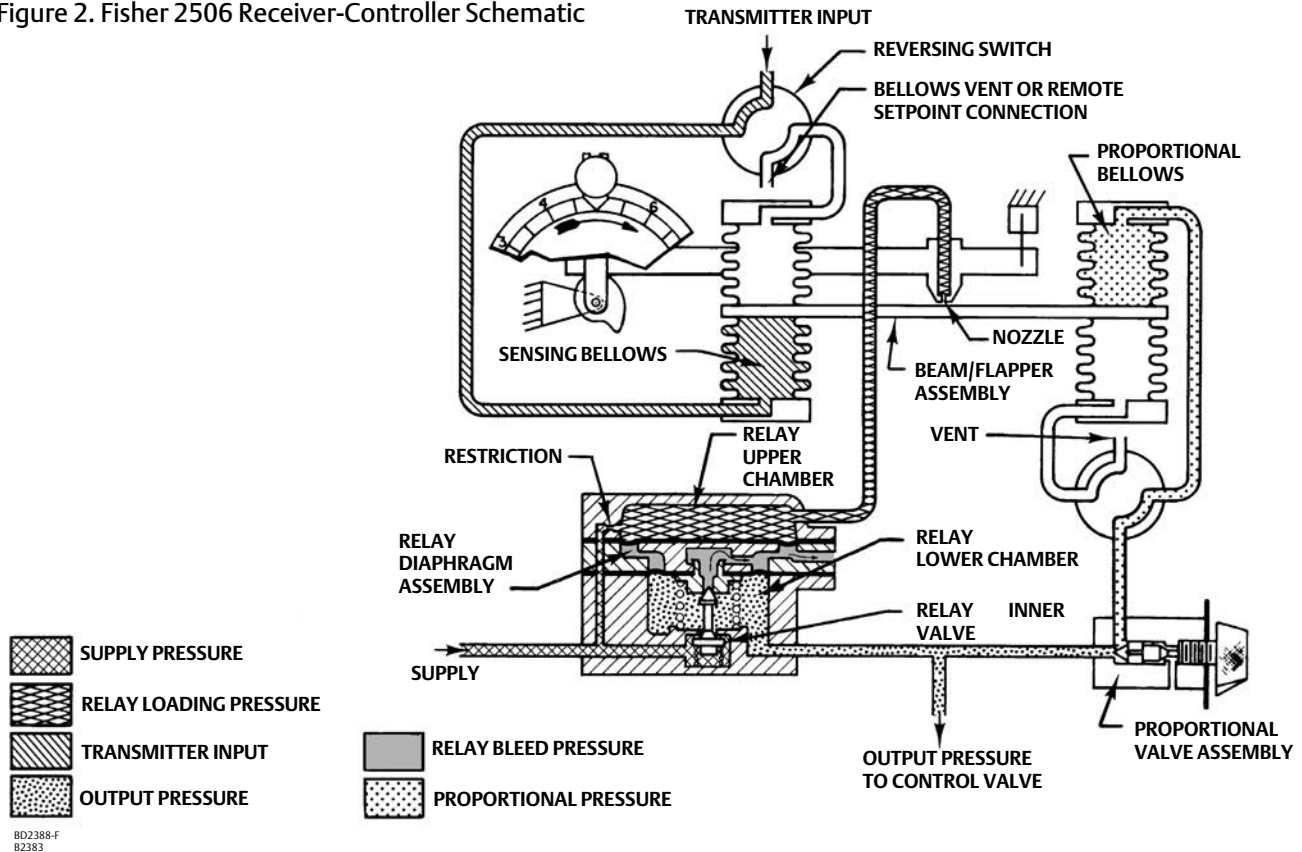

Principle of Operation

2506 Receiver-Controller

The principle of operation for the direct acting 2506 receiver-controller is illustrated in figure 2.

Supply pressure enters the inlet side of the relay and input pressure from the transmitter enters the reversing switch. Output pressure from the receiver-controller is delivered to the diaphragm of the control valve actuator.

As long as the transmitter input pressure and process level remain constant, the bellows beam remains motionless. This allows the supply pressure to bleed through the nozzle as fast as it enters the relay through the fixed restriction.

If there is an increase in pressure from the transmitter, pressure increases in the sensing bellows assembly,

tending to push the beam toward the nozzle. This action builds up pressure in the relay's upper chamber as air continues to pass through the fixed restriction. The buildup of pressure in the upper chamber pushes the relay diaphragm assembly downward, opening the relay supply valve. Supply pressure then flows into the relay's lower chamber until the relay diaphragm assembly is pushed back to its original position and the relay valve is closed again. The increased pressure in the lower chamber is transmitted to the diaphragm of the control valve actuator.

At this same time, pressure in the proportional bellows assembly is being increased through the 3-way proportional valve assembly, which causes the beam to move away from the nozzle, thus stopping the pressure buildup in the relay's upper chamber. The receiver-controller is again in equilibrium with an increased input from the transmitter and an increased output to the diaphragm of the control valve actuator. If a decrease in transmitter input pressure occurs, the reverse of the above cycle takes place, with a decrease in output pressure.

Figure 3. Fisher 2516 Receiver-Controller Schematic

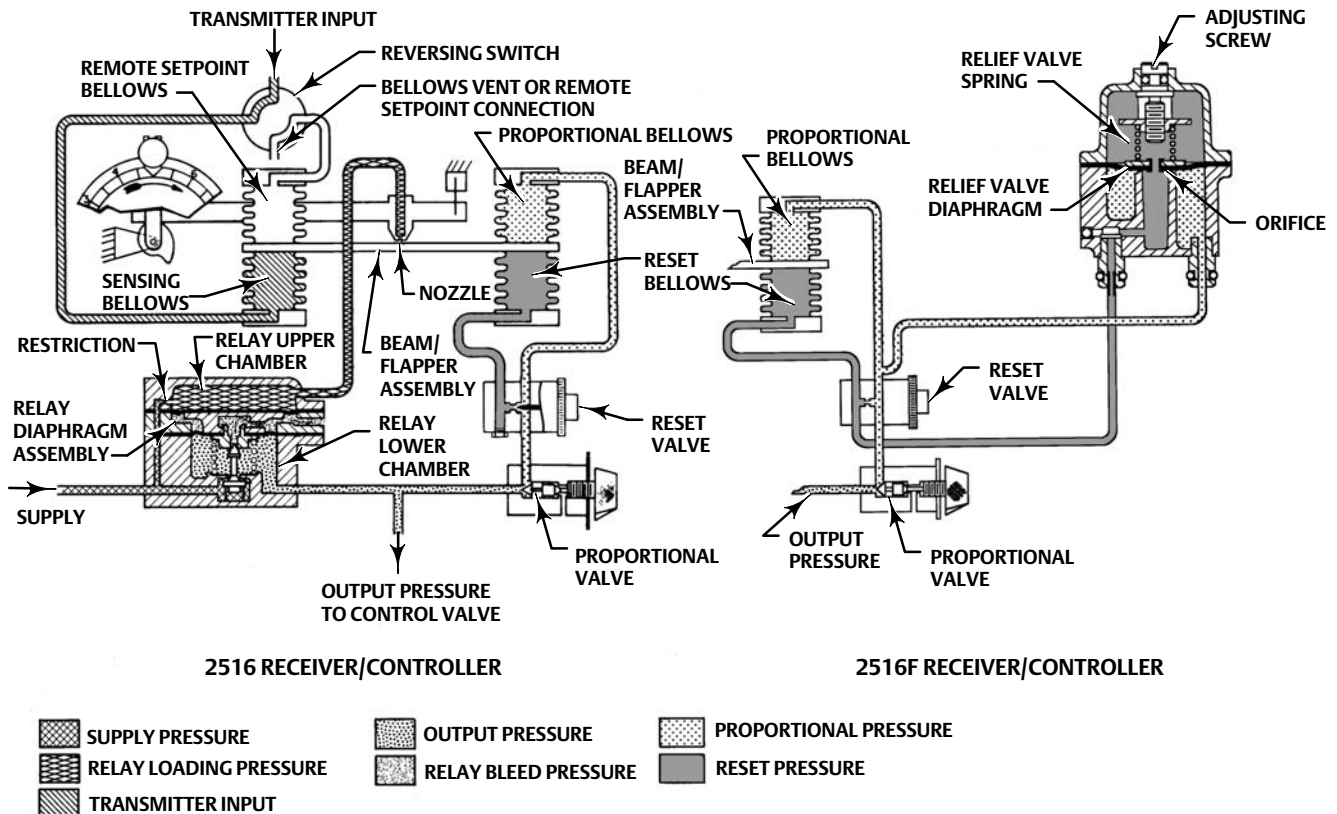

38B6019-A
38A2972-A
B02389-E
B2384-1

2516 Receiver-Controller

The principle of operation for the 2516 receiver-controller is the same as the 2506 receiver-controller, but includes a reset adjustment. Refer to figure 3.

Note from the principle of operation of the 2506 receiver-controller that an increase in pressure from the transmitter increases the pressure in the sensing bellows, moves the beam toward the nozzle, increases the pressure to the control valve, and at the same time increases the pressure through the proportional valve to the proportional bellows, thus stopping the pressure buildup to the control valve.

With the 2516 receiver-controller, the pressure in the line leading to the proportional bellows slowly passes through the reset valve and builds up the pressure in the reset bellows. Pressure buildup in the reset bellows pushes the beam toward the

nozzle, again increasing the pressure throughout the system to the control valve actuator and proportional bellows. Increased pressure to the control valve actuator increases pressure through the reset valve to the reset bellows and starts another increase in the pressure throughout the system and to the control valve. This pressure buildup in the system continues until the pressure from the transmitter is decreased and the system is brought back to the set point.

If a change in the system causes a decrease in outlet pressure, the reverse of the above cycle takes place.

The above pressure changes are simultaneous and are described above as a step-by-step sequence for explanation purposes only.

The reset adjustment dial on the 2516 receiver-controller is calibrated in minutes per repeat. This is the time in minutes required for the reset action to produce a quantity correction which is equal to the correction produced by proportional control action. In other words, this is the time in minutes required for

the controller to increase its output pressure by an amount equal to previous proportional increase caused by a change in control conditions.

2516F Receiver-Controller

During a prolonged difference between set point and the controlled variable, such as encountered with intermittent control applications (e.g., batch temperature control or wide open monitors on pressure control), reset ramps the controller output to either zero or full supply pressure; this condition is reset windup. When the controlled variable crosses the set point, there will be a delay before the controller output responds to the change in controlled variable. Anti-reset windup minimizes this delay and permits returning the controlled variable to set point more quickly with minimal overshoot.

The 2516 receiver-controller also has an anti-reset windup relief valve (2516F). Refer to figure 3. This valve provides differential pressure relief to prevent

proportional pressure from exceeding reset pressure by more than a set value. The valve consists of two pressure chambers separated by a spring-loaded diaphragm. Reset pressure registers on the spring side of the diaphragm and proportional pressure registers on the other side. As long as controlled pressure changes are slow enough for normal proportional and reset action, the relief valve spring will keep the relief valve diaphragm from opening. However, a large or rapid increase in controller pressure will cause the relay to increase loading pressure to the control device. The increase in controller pressure also causes the pressure to increase in the proportional system and on the proportional side of the relief valve diaphragm. If this increase is greater than the relief valve spring setting, the relief diaphragm moves off the orifice in the differential relief valve. This allows the pressure on the proportional side of the diaphragm to bleed into the reset system. This action provides quick relief of excessive proportional pressure and reduces the time required by the system to return to the control point. A user can reverse the differential relief action to relieve on decreasing output pressure.

Installation

Figure 4 illustrates the installation of a 2506 or 2516 receiver-controller on a Fisher 2500 transmitter. In this case, the receiver-controller input connection and the supply pressure connection are made at the factory. To complete the installation, a 1/4-inch line is run from the connection marked on the back of the receiver-controller case (figure 5) to the connection on the diaphragm case of the actuator.

Figure 6 illustrates the mounting of the 2506 or 2516 receiver-controller on the yoke of an actuator. In this case, the diaphragm connection is made at the factory. The supply pressure line should be connected to the 1/4 NPT INPUT connection of the regulator, if used, mounted on the yoke of the actuator. Also, a 1/4-inch line is run from the INSTRUMENT connection on the back of the receiver-controller case (figure 5) to the OUTPUT connection of the transmitter.

Figure 5 illustrates the dimensions for the 2506 and 2516 receiver-controller.

Ordering Information

When ordering, specify:

Application

1. Description of the service, such as throttling or on-off
2. Pressure range, composition, and temperature of the process fluid
3. Ambient temperature

Construction

Refer to the specifications. Carefully review each specification, indicating your choice whenever a selection is to be made.

Figure 4. Receiver-Controller Mounted on a Fisher 2500 Controller/Transmitter

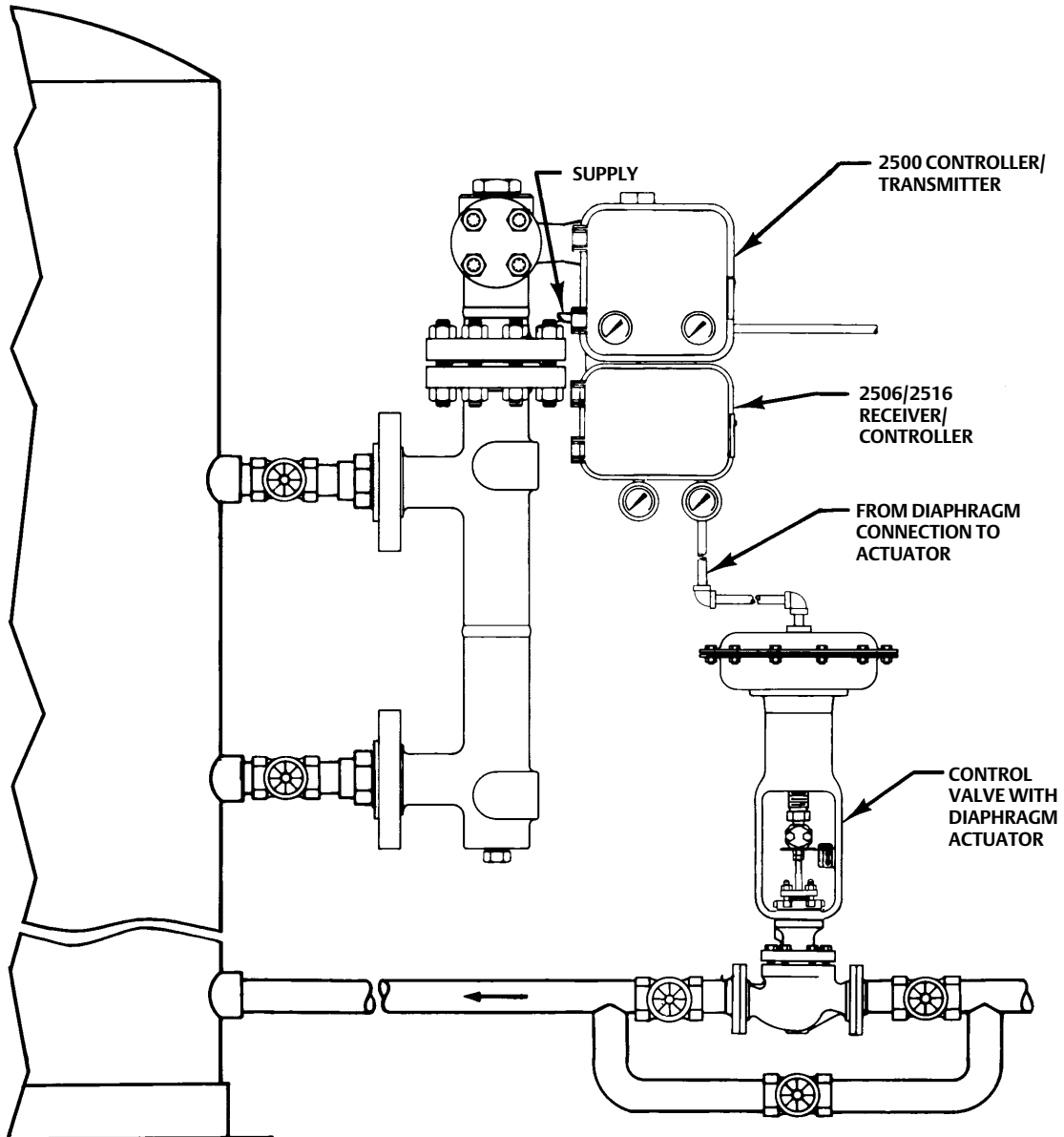

DF5357-A
A6041

Figure 5. Dimensions

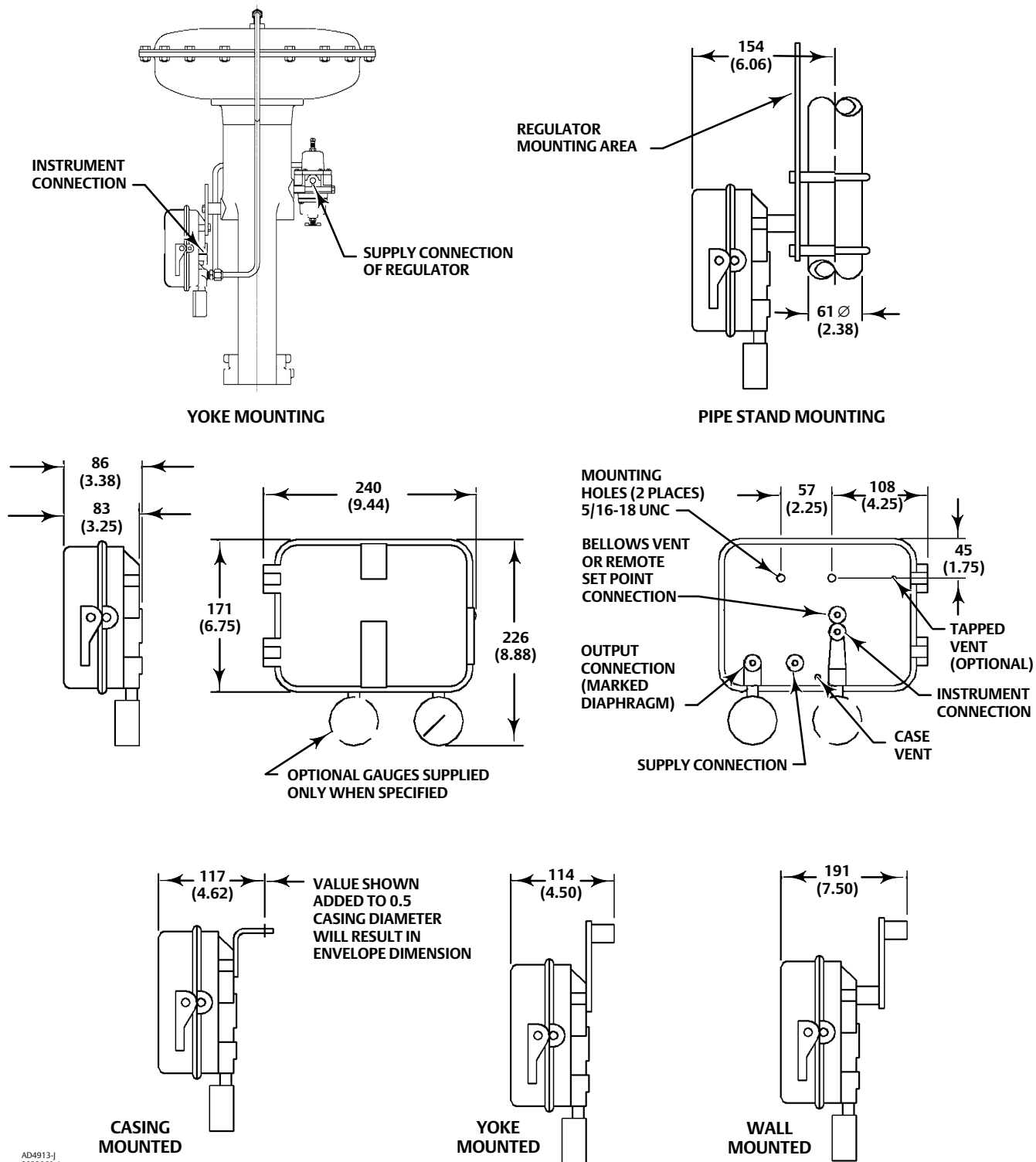

AD4913-J
3883960-A
B2032-2

Figure 6. Receiver-Controller Mounted on the Actuator Yoke

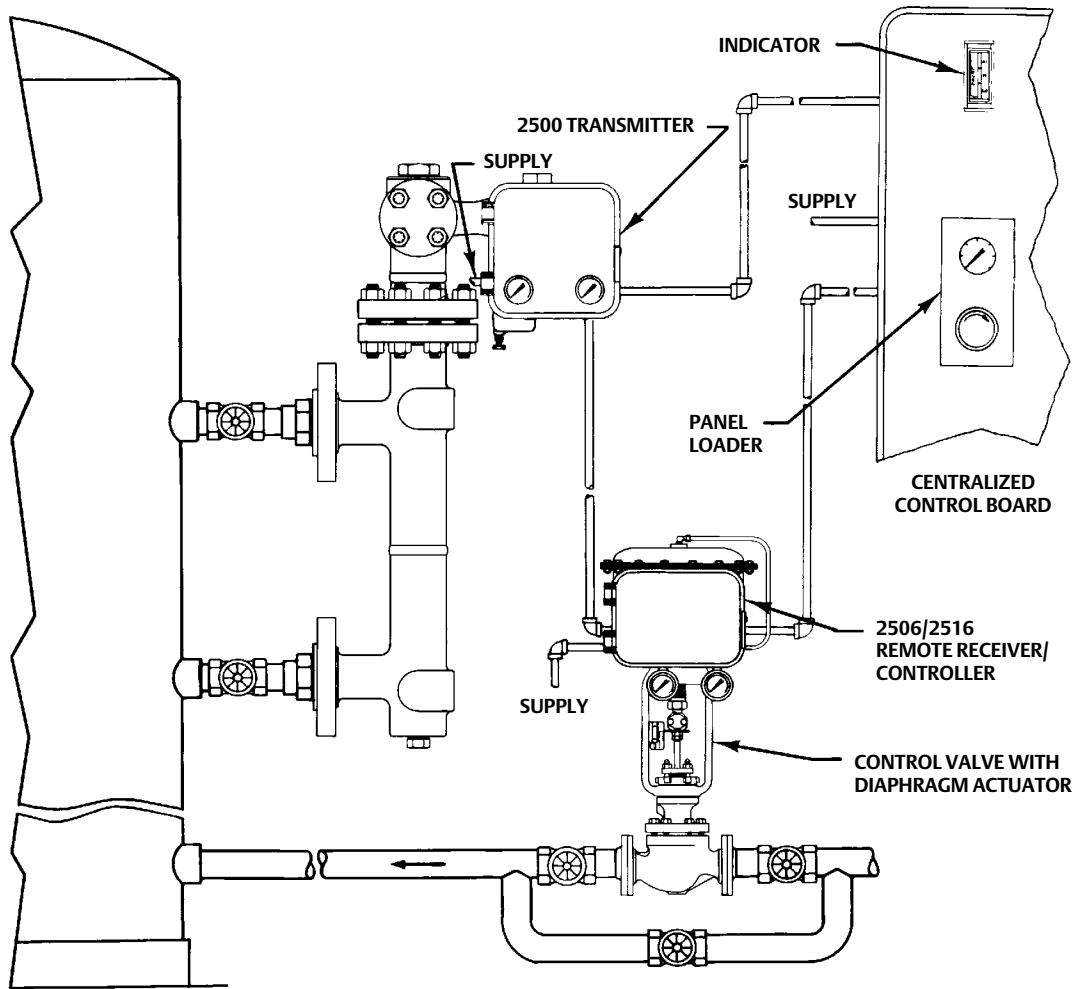

Product Bulletin

34.3:2506
August 2017

2506/2516 Receiver Controllers

D200044X012

Neither Emerson, Emerson Automation Solutions, nor any of their affiliated entities assumes responsibility for the selection, use or maintenance of any product. Responsibility for proper selection, use, and maintenance of any product remains solely with the purchaser and end user.

Fisher is a mark owned by one of the companies in the Emerson Automation Solutions business unit of Emerson Electric Co. Emerson Automation Solutions, Emerson, and the Emerson logo are trademarks and service marks of Emerson Electric Co. All other marks are the property of their respective owners.

The contents of this publication are presented for informational purposes only, and while every effort has been made to ensure their accuracy, they are not to be construed as warranties or guarantees, express or implied, regarding the products or services described herein or their use or applicability. All sales are governed by our terms and conditions, which are available upon request. We reserve the right to modify or improve the designs or specifications of such products at any time without notice.

Emerson Automation Solutions
Marshalltown, Iowa 50158 USA
Sorocaba, 18087 Brazil
Cernay 68700 France
Dubai, United Arab Emirates
Singapore 128461 Singapore

www.Fisher.com

