

Paine™ 215-01-080 Series Temperature Sensor

Platinum RTD, Surface, High Temperature, +250 °C

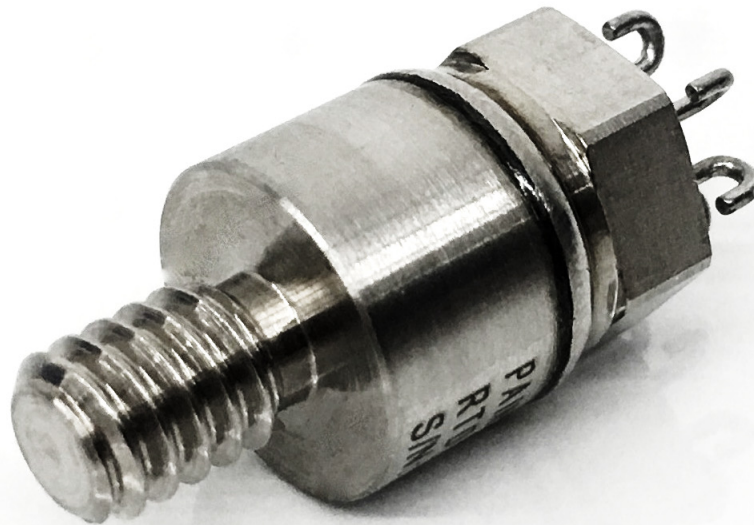

The Paine 215-01-080 Series, Surface, Temperature Sensor is a platinum resistance temperature detector (RTD) probe designed for high temperatures up to 482 °F (250 °C). Engineered as a compact and corrosion-resistant sensor, this RTD probe features long-term performance with reliability, stability, and repeatability. These sensors provide accuracy and rapid response times and are well suited for critical surface temperature measurements of machinery and process equipment.

Solutions

- Platinum RTD
- Harsh/extreme environment ready
- 0.515-in. diameter package
- Fast response time
- Long term stability

Potential applications

- Oil and gas thermal controls
- Exhaust gas and manifold analyzers
- HVAC temperature controls
- Industrial/production process equipment
- Heavy equipment/transportation
- Engine temperature monitoring
- Equipment calibration

Features

- **Operating temperature:** -4 to +482 °F (-20 to +150 °C)
- **Temperature coefficient:** Alpha = 0.00385 per °C
- **Platinum resistance temperature detector (RTD):**
Class A, Pt 1 kΩ ± 0.06% at 32 °F (0 °C)
- **Material:**
 - **Hex header:** Alloy X750
 - **Case:** Alloy 718, UNSN07718, solution annealed and aged to Rockwell C40 maximum
- **External pressure rating:** 20,000 psi (1378 bar) maximum
- **Vibration:** 20–2000 Hz, 10 g sinusoidal scan, 1 hour/axis

Specifications

Calibration: Calibration certificates are supplied with each unit and available online.

Performance

Temperature coefficient: Alpha = 0.00385 nominal per °C

Platinum resistance temperature detector (RTD):
Class A, Pt 1 kΩ ± 0.06% at 32 °F (0 °C)

Environmental

Operating temperature range: -4 °F to +482 °F
(-20 °C to +250 °C)

Mechanical

Material:

Hex header: Alloy X750

Case: Alloy 718, UNSN07718, solution annealed and aged to Rockwell C40 = maximum

External pressure rating: 20,000 psi (1,378 bar) maximum.

Vibration: 20–2000 Hz, 10 g sinusoidal scan, 1 hour/axis.

Shock: 75 G's peak, 3.5–5 milliseconds, six shocks each of six directions. (No pin is electrically connected to the case).

Pressure fitting: 1/4 × 20 UNC-2A.

Weight: 2 ounces maximum (0.05 kg).

Installation information: Manifold/flush mount.

Electrical

Insulation resistance: 5,000 MΩ minimum at 50 VDC at 75 °F (23 °C) all pins to case

Electrical connections: Available with pin connectors, lead wires, and j-hooks.

Contents

Specifications 2 Dimensional Drawings 3

Dimensional Drawings

Figure 1. Paine 215-01-080 Series

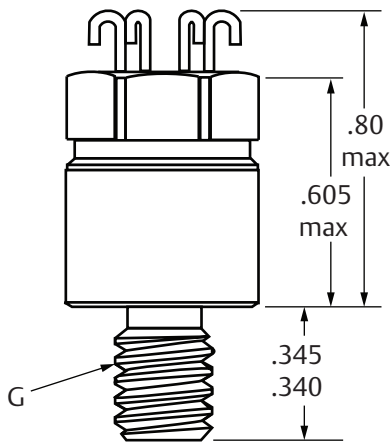
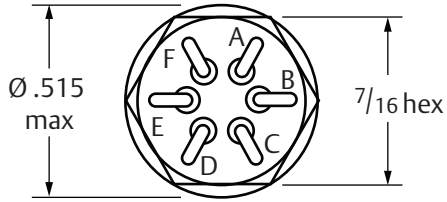



Connections	
PIN	Function
A	1 k Ω RTD
B	Do not connect
C	Do not connect
D	Do not connect
E	Do not connect
F	1 k Ω RTD

A-F. See Connections table
 G. $1/4 \times 20$ UNC-2A thread
 Dimensions are shown in inches.

Rosemount Specialty Product LLC

Emerson Automation Solutions

5545 Nelpar Drive
East Wenatchee, WA 98822, USA

-  +1 509 881 2100
-  +1 509 881 2115
-  Paine.Products@Emerson.com

 [Linkedin.com/company/Emerson-Automation-Solutions](https://www.linkedin.com/company/Emerson-Automation-Solutions)

 [Twitter.com/Rosemount_News](https://twitter.com/Rosemount_News)

 [Facebook.com/Rosemount](https://www.facebook.com/Rosemount)

 [Youtube.com/user/RosemountMeasurement](https://www.youtube.com/user/RosemountMeasurement)

 [Google.com/+RosemountMeasurement](https://plus.google.com/+RosemountMeasurement)

Standard Terms and Conditions of Sale can be found on the [Terms and Conditions of Sale page](#).
The Emerson logo is a trademark and service mark of Emerson Electric Co.
The Paine brand and Paine logotype are trademarks of Emerson Electric Co.
All other marks are the property of their respective owners.
© 2017 Emerson. All rights reserved.