

# EGS QDC Nuclear Connector

Designed and manufactured by



- Generation 1 and Generation 3
- Bayonet style connector for use inside or outside containment
- Stainless steel connector body
- Qualified with Rosemount 3150 Series and 1150 Series pressure transmitters for mild and harsh service



## Contents

Product Description.....	page 2
Features and Benefits.....	page 2
Qualification Standards and Reports.....	page 3
Nuclear Specifications.....	page 3
Functional Specifications.....	page 5
Physical Specifications.....	page 5
Dimensional Drawings.....	page 7
Installation and Maintenance.....	page 8
Ordering Information.....	page 9

## PRODUCT DESCRIPTION

EGS 1/2 - inch bayonet style quick-disconnect (QDC) nuclear electrical connectors (Generation 1 and Generation 3) can be purchased from Rosemount Nuclear Instruments, Inc. (RNII), individually or factory-mounted to Rosemount nuclear qualified pressure transmitters.

EGS QDC has been qualified by Curtiss-Wright for Class 1E applications in accordance with IEEE Standards. Additionally, RNII has qualified EGS QDCs for use with Rosemount 1150 Series and 3150 Series pressure transmitters with no impact to existing published specifications.

When ordered from RNII, the Generation 3 EGS QDC includes design enhancements for higher performance with pressure transmitters, including secondary silicone inner seal and 360° EMI shield with double-shielded cable. Generation 3 EGS QDC has higher environmental qualification levels compared to the legacy Generation 1 EGS QDC, and is qualified for submergence and extended high steam pressure/temperature environment post-accident monitoring applications.

The EGS QDC is designed and manufactured by Curtiss-Wright under a nuclear quality assurance program that meets the requirements of NQA-1, 10CFR50 Appendix B, and 10CFR21.

## FEATURES AND BENEFITS

- Qualified with Rosemount 1150 Series & 3150 Series pressure transmitters
- Easy installation/assembly
- Option for factory mounting to Rosemount Nuclear qualified pressure transmitters
- Small and lightweight
- No special tools or pre-assembly required
- Bayonet style with visual locking indicator
- Stainless Steel connector body
- When ordered from RNII, the Gen 3 includes secondary silicone inner seal and 360° EMI shield with double-shielded cable
- Gen 3 qualified for submergence applications
- Welded Gen 3 instrument-side available with Rosemount 3155N for severe accident and post-accident monitoring applications (see 3155N Product Data Sheet 00813-0100-4855 for details)

Figure 1 – 1/2-inch Bayonet Style EGS QDC (Gen 3 shown)

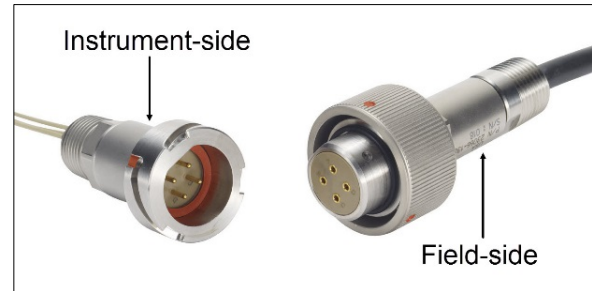

Figure 2 – Side-mounted Gen 1 EGS QDC shown on Rosemount 3152 and 3153 Pressure Transmitters



Figure 3 – Top-mounted Gen 3 EGS QDC shown on a Rosemount 3154 Pressure Transmitter



**QUALIFICATION STANDARDS AND REPORTS**

**Generation 1 EGS QDC**

Qualified according to:

- IEEE 572 – 1985
- IEEE 323 – 1974/1983
- IEEE 344 – 1987
- IEEE 382 – 1980
- 10CFR50.49

As documented in Curtiss-Wright Reports:

- PEI-TR-880701-04
- EGS-TR-880706-05

**Generation 3 EGS QDC**

Qualified according to:

- IEEE 572 – 1985/2006
- IEEE 323 – 1974/1983/2003
- IEEE 344 – 1975/1987/2004
- IEEE 382 – 1980/1996/2006
- 10CFR50.49

As documented in Curtiss-Wright Reports:

- EGS-TR-23009-14
- EGS-TR-23066-08
- EGS-TR-23066-11
- EGS-TR-23066-18
- EGS-TR-23066-25

**When Used With Rosemount Pressure Transmitters:**

Rosemount Report D9900158 demonstrates that the published seismic performance specifications of Rosemount 1150 Series pressure transmitters are maintained when the Gen 1 EGS QDC is installed.

Rosemount Report D2012008 describes the qualification of NPT threaded Gen 1 and Gen 3 EGS QDCs with Rosemount 3150 Series pressure transmitters. When a Gen 1 or Gen 3 EGS QDC is installed, the published seismic and environmental performance specifications of Rosemount 3150 Series pressure transmitters are maintained.<sup>(1) (2)</sup> The qualification of the welded Gen 3 EGS QDC with Rosemount 3155N pressure transmitters is described in Rosemount Reports D2015008 and D2015009.

Notes:

- (1) Gen 1 EGS QDC is not qualified for submergence applications.
- (2) Gen 3 EGS QDC supplied by RNII is qualified for submergence applications and includes secondary silicone inner seal and 360° EMI cable shield with double-shielded cable design enhancements.

**SPECIFICATIONS**

**Nuclear Specifications**

Nuclear specifications as qualified by Curtiss-Wright are listed in the table below.

EGS QDC Nuclear Specifications

	Generation 1	Generation 3
<b>Qualified Life</b>	Connector: 40 years at 150 °F (66 °C) EPDM O-ring: 10 years at 150 °F (66 °C)	Connector: 60 years at 144 °F (62.3 °C) EPDM O-ring & Silicone gasket: 25 years at 144 °F (62.3 °C)
<b>Radiation</b>	200 Mrad-air (2 MGy) TID gamma (normal and accident conditions)	231.5 Mrad-air (2.315 MGy) TID (normal and accident conditions)
<b>Seismic</b>	8.3g ZPA (SSE)	7g ZPA (SSE)
<b>LOCA</b>	435 °F (224 °C), 77 psig (531 kPa), chemical spray, 100% relative humidity	435 °F (224 °C), 75 psig (517 kPa), chemical spray, 100% relative humidity, submergence
<b>Post-accident Aging</b>	Equivalent to 1 year at 200 °F (93 °C)	Equivalent to 1 year at 200 °F (93 °C)
<b>Submergence</b>	Not Applicable	Up to 1 year at 285 °F (140.6 °C), 62 psia (428 kPa)

Figure 4 – LOCA profile applicable to the Generation 1 EGS QDC<sup>(1)</sup>

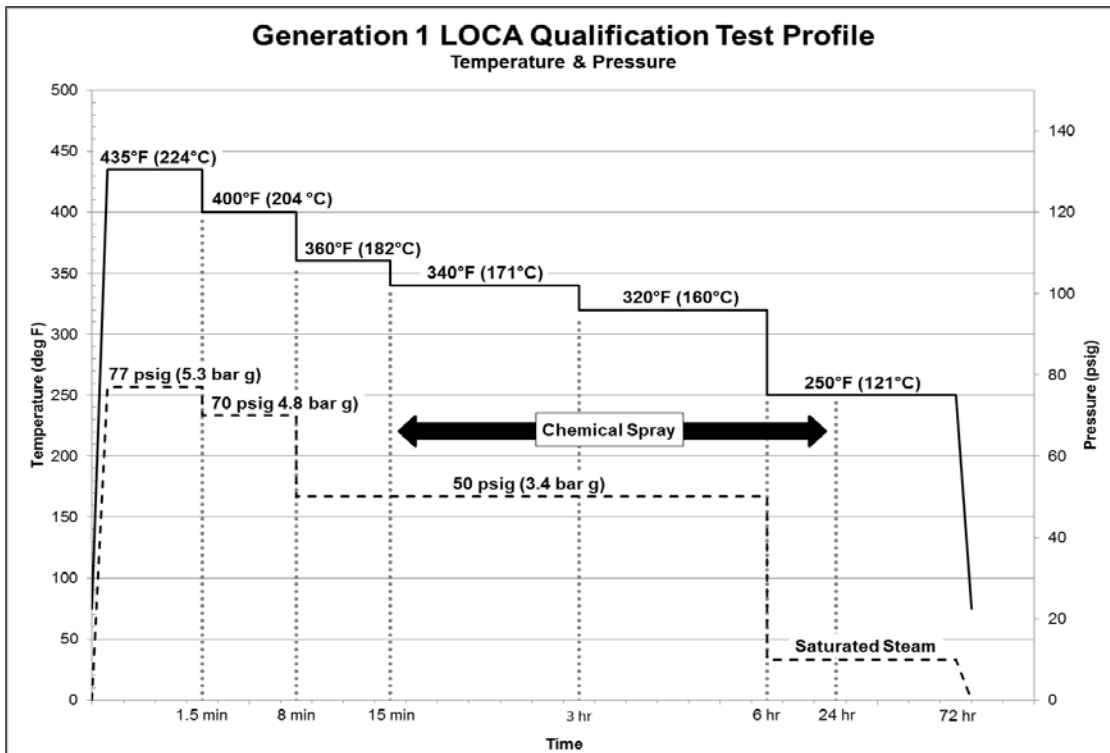
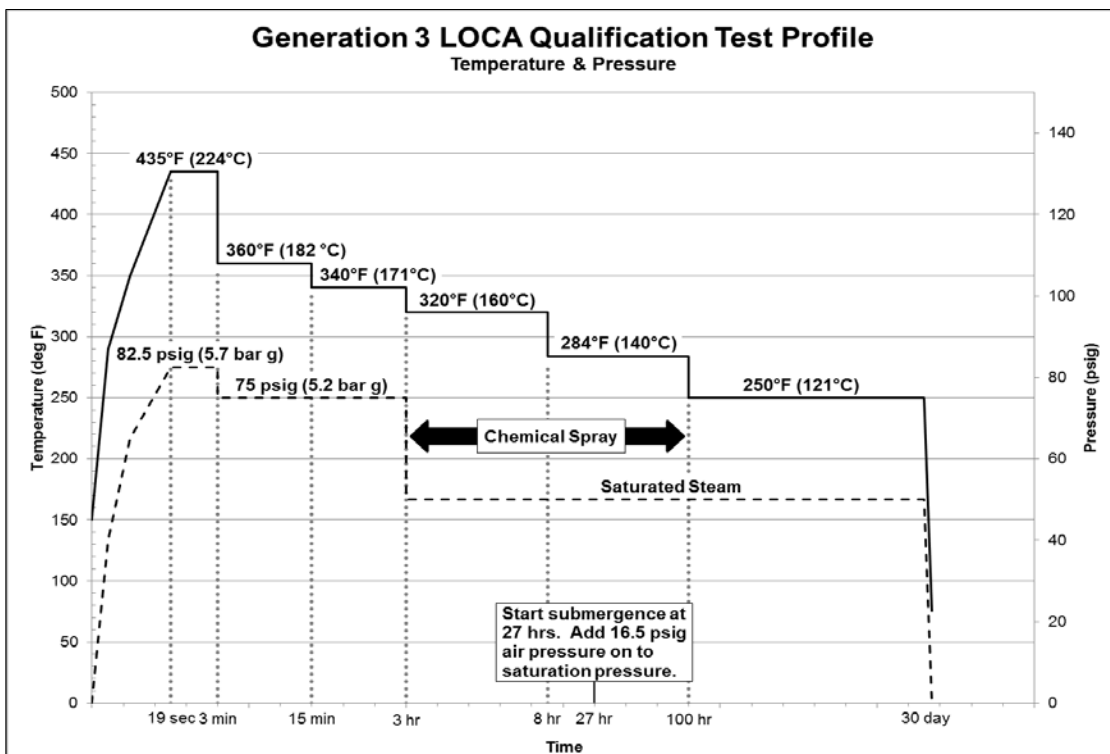

Figure 5 – LOCA profile applicable to the Generation 3 EGS QDC<sup>(1)</sup>



Note:

(1) LOCA profile is per Curtiss-Wright report(s).

## Functional Specifications

	Generation 1	Generation 3
<b>Dielectric Withstand</b>	60 sec at 2200 VAC; leakage current $\leq$ 5 mAmps	60 sec at 2200 VAC; leakage current $\leq$ 5 mAmps
<b>Insulation Resistance</b>	15 sec at 500 VDC; IR $\geq$ 10 GOhm	15 sec at 500 VDC; IR $\geq$ 10 GOhm

## Electrical Specifications

	Generation 1	Generation 3
<b>Wire Size</b>	16 AWG	16 AWG
<b>Number of Wires</b>	2, 3	2, 3
<b>Rated Voltage</b>	600 volts	600 volts
<b>Rated Current at 194 °F (90 °C)</b>	13 amps	13 amps
<b>Rated Contact Resistance</b>	0.004 ohms	0.004 ohms
<b>Field-side Cable Length</b>	See Ordering Information Table on page 9	See Ordering Information Table on page 9
<b>Instrument-side Lead Wire Length</b>	8 in. (200 mm)	8 in. (200 mm)

## Physical Specifications

	Generation 1	Generation 3 <sup>(1)</sup>
<b>Weight (excluding fittings and lead wires)</b>	Instrument-side: 0.30 lb (0.14 kg) Field-side: 0.30 lb (0.14 kg)	Instrument-side: 0.30 lb (0.14 kg) Field-side: 0.50 lb (0.23 kg)
<b>Dimensions</b>	See Figure 6	See Figure 7

## Materials of Construction

	Generation 1	Generation 3 <sup>(1)</sup>
<b>Body</b>	17-4 PH SST	17-4 PH SST and 304 SST
<b>Insulator</b>	PEI	PEEK
<b>Sealing</b>	EPDM O-ring	EPDM O-ring and Silicone Inner Seal
<b>Potting</b>	Patel Type 3	Epoxy Type 7 and 8
<b>Lead Wire</b>	Rockbestos Firewall® SIS XLPE	Solid core PEEK
<b>Field Cable</b>	See Page 6 for Details	See Page 6 for Details

Note:

- (1) When ordered from RNII, the Gen 3 EGS QDC includes secondary silicone inner seal and 360° EMI shield with double-shielded cable design enhancements.

**Rockbestos Firewall® III Cable**

EGS QDCs available from RNII include Firewall® III cables, which are designed and manufactured by Rockbestos-Surprenant Cable Corporation (RSCC) under a nuclear quality assurance program that meets the requirements of NQA-1, 10CFR50 Appendix B, and 10CFR21. RSCC has qualified Firewall® III cables for Class 1E applications in accordance with IEEE Standard 323 – 1974 and IEEE Standard 383 – 1974. For qualification documentation please contact RSCC.

**Rockbestos Firewall® III Cable Specifications**

	Generation 1		Generation 3	
	2-wire	3-wire	2-wire	3-wire
<b>Product Number</b>	I46-0021	I46-0031	I56-3670	I56-3624
<b>Outer Diameter</b>	0.310 in. (7.87 mm)	0.330 in. (8.38 mm)	0.345 in. (8.76 mm)	0.360 in. (9.14 mm)
<b>Cable Weight (lb/1000 ft)</b>	65 (96.7 kg/km)	81 (120.5 kg/km)	79 (117.6 kg/km)	92 (136.9 kg/km)
<b>Conductor</b>	16 AWG, 7 strand, 0.0192 in. (0.488 mm) Tinned Copper		16 AWG, 7 strand, 0.0192 in. (0.488 mm) Tinned Copper	
<b>Insulation</b>	0.025 in. (0.64 mm) FR-XLPE <sup>(1)</sup>		0.025 in. (0.64 mm) FR-XLPE <sup>(1)</sup>	
<b>Shielding</b>	Laminated Aluminum / Polyester Tape Shield with Tin-coated Copper Drain Wire		Tinned Copper Braid with Laminated Copper / Polyester Tape Shield	
<b>Jacket</b>	0.045 in. (1.1 mm) CSPE <sup>(2)</sup>		0.045 in. (1.1 mm) FR-XLPE <sup>(1)</sup>	

Notes:

- (1) FR-XLPE: Flame Retardant Cross-Linked Polyethylene
- (2) CSPE: Chlorosulfonated Polyethylene

Figure 6 – Generation 1 EGS QDC Dimensional Drawing<sup>(1)</sup>

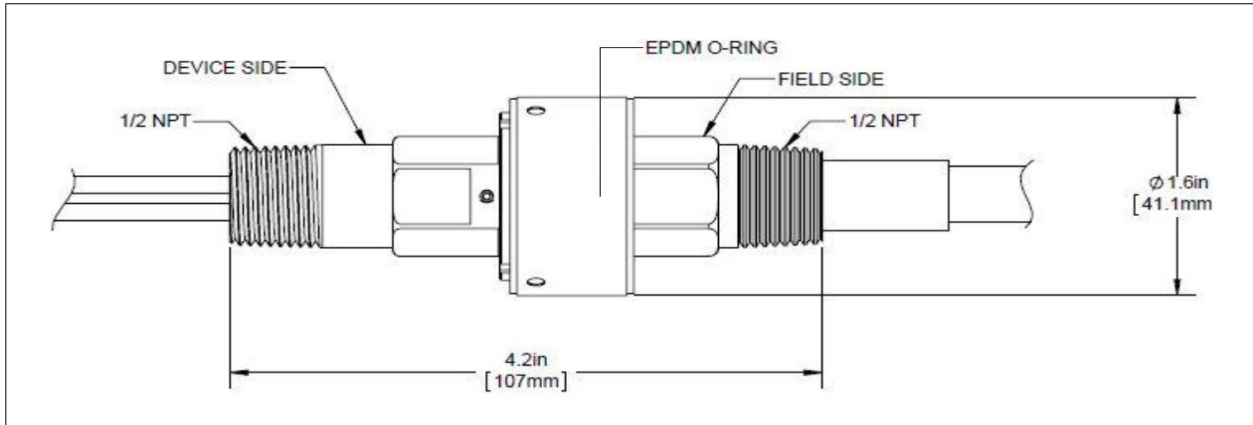

Figure 7 – Generation 3 EGS QDC Dimensional Drawing<sup>(1) (2)</sup>

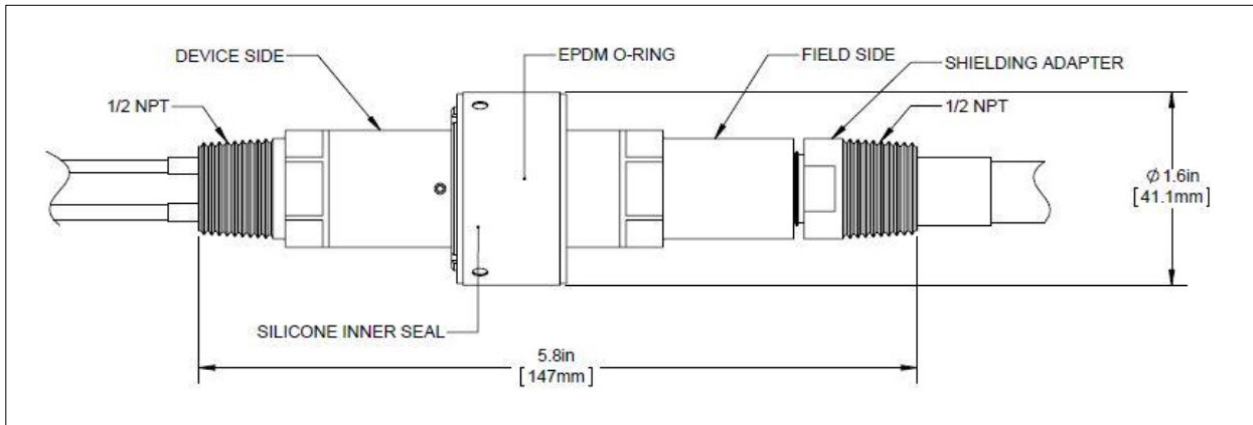
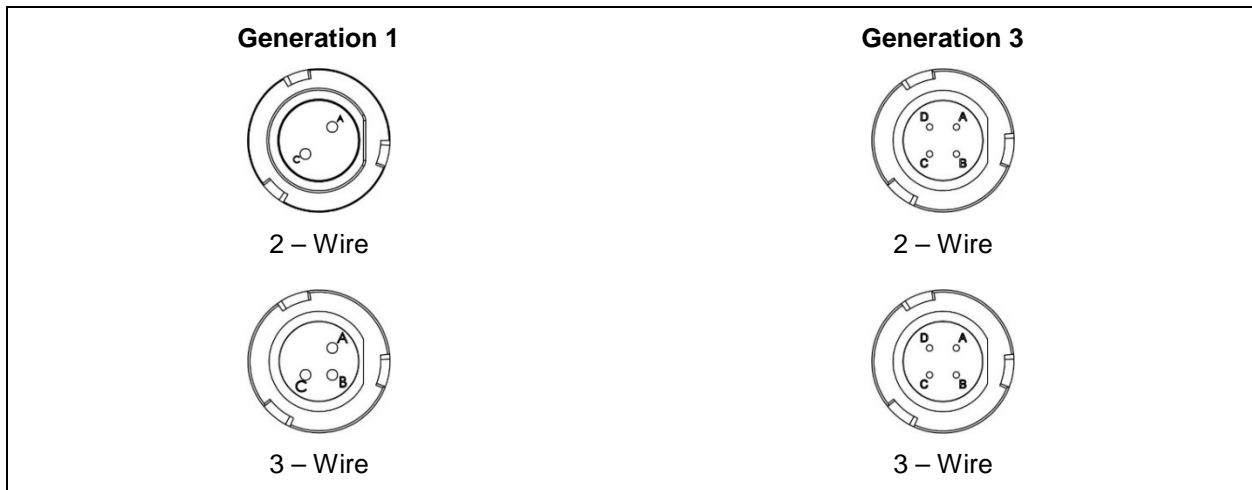

Figure 8 – EGS QDC Wiring Scheme<sup>(3)</sup>



**Notes:**

- (1) All dimensions are nominal in inches [millimeters].
- (2) When ordered from RNII, the Gen 3 EGS QDC includes secondary silicone inner seal and 360° EMI shield with double-shielded cable design enhancements.
- (3) When the EGS QDC is factory installed to Rosemount nuclear qualified pressure transmitters: pin A is connected to the positive terminal, pin C is connected to the negative terminal, and pin B is connected to the case ground.

## INSTALLATION AND MAINTENANCE

The EGS QDC can be installed on Rosemount 3150 Series and 1150 Series nuclear qualified transmitters using the integral lead wire (see Figure 9). Detailed installation instructions are provided in Curtiss-Wright Reports EGS-TR-880706-01 (Gen 1) or EGS-TR-23066-04 (Gen 3).

If the EGS QDC is not factory installed by Rosemount, qualification of the instrument/connector interface becomes the user's responsibility.

No scheduled or preventative maintenance is necessary for the EGS QDCs other than replacement of the EPDM O-ring (Gen 1 and Gen 3) and silicone inner seal (Gen 3 only) per Curtiss-Wright requirements. Particularly, whenever the QDC is disconnected after one week or more installed service, the EPDM O-ring (Gen 1 and Gen 3) and silicone inner seal (Gen 3 only) must be replaced prior to reconnection.

Figure 9 – Typical EGS QDC Installation on Rosemount Pressure Transmitter

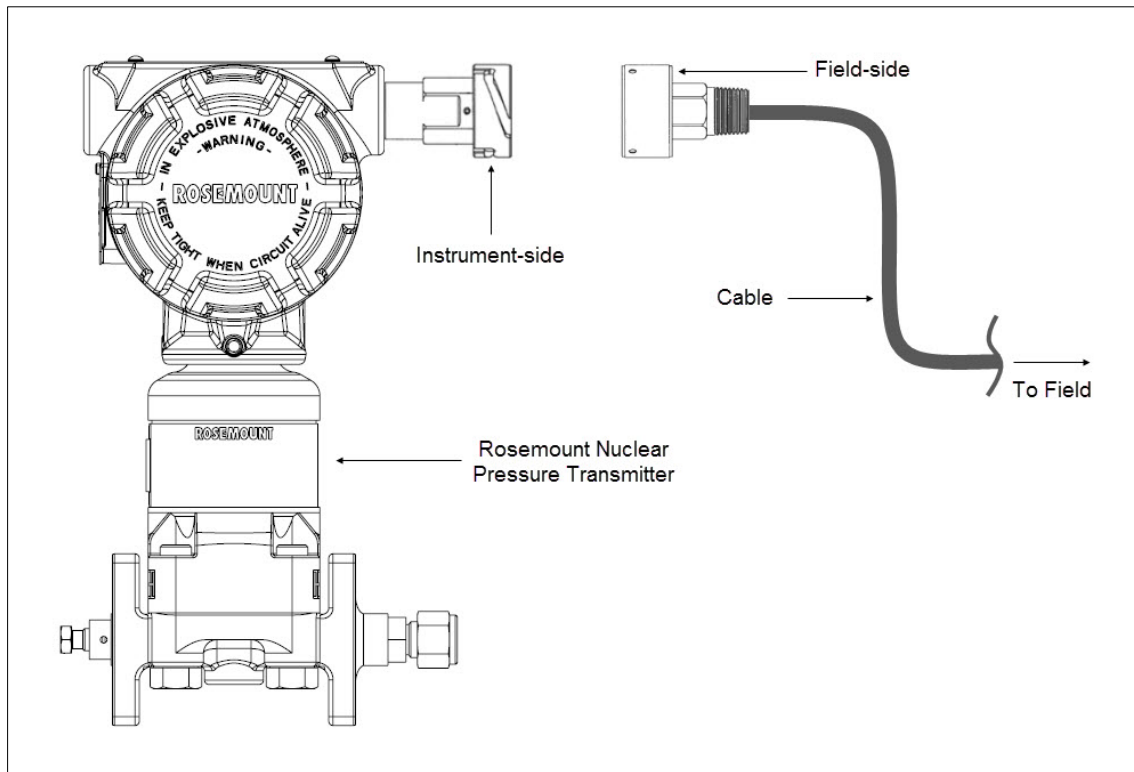



**ORDERING INFORMATION<sup>(1)</sup>**

<b>Model</b>	<b>Description</b>
QDC	EGS QDC Nuclear Electrical Connector
<b>Code</b>	<b>Connector Model</b>
1	Generation 1 EGS QDC <sup>(2)</sup>
3	Generation 3 EGS QDC <sup>(3)</sup>
<b>Code</b>	<b>Connector Configuration</b>
A	Instrument-side Only (NPT Potted)
B	Field-side Only <sup>(4)</sup>
C	Instrument-side (NPT Potted) + Field-side
<b>Code</b>	<b>Assemble to Flag<sup>(5)</sup></b>
0	Connector Only; Not Ordered with Transmitter
1	Connector Assembled to Transmitter
<b>Code</b>	<b>Number of Wires</b>
W2	2 Wires
W3	3 Wires
<b>Code</b>	<b>Cable Length (Field-side)<sup>(1)</sup></b>
C000	No Field-side; Instrument-side Only
C020	20 feet (6.10 meters)
C040	40 feet (12.19 meters)

**Notes:**

- (1) For configurations not listed, including additional cable lengths and flexible conduit cable options, please contact Rosemount Nuclear Instruments, Inc.
- (2) Gen 1 EGS QDC:
  - Available in 2-pin/2-wire or 3-pin/3-wire configurations
  - 16 AWG Rockbestos Firewall<sup>®</sup> SIS type stranded lead wires with ring terminals (Instrument-side)
  - Rockbestos Firewall<sup>®</sup> III cable (FR-XLPE/CSPE), laminated aluminum/polyester tape shield with tin-coated copper drain wire (Field-side)
- (3) When ordered from RNII, the Gen 3 EGS QDC includes the following enhanced design features:
  - 4-pin connector available in 2-wire or 3-wire configurations
  - 16 AWG solid core PEEK-insulated lead wires with ring terminals (Instrument-side)
  - Secondary silicone inner seal (Instrument-side)
  - Shielded Rockbestos Firewall<sup>®</sup> III cable (FR-XLPE/FR-XLPE), tinned copper braid with laminated copper/polyester tape shield (Field-side)
  - 360° EMI cable shield attachment (Field-side)
- (4) Connector Configuration Code "B" must be selected when ordering Gen 3 EGS QDC Field-side connectors for the Rosemount 3155N pressure transmitter.
- (5) Assemble to Flag Code "0" should be used when ordering spare EGS QDC connectors for on-site installation by the end user. When Assemble to Flag Code "1" is selected, the instrument-side connector is factory-installed with pin A to the positive terminal.
- (6) Spare EPDM O-rings for the Gen 1 and Gen 3 EGS QDCs can be ordered using Rosemount kit number 03154-5801-0001 (Qty. 10 per kit). Spare silicone inner seal for the Gen 3 EGS QDC can be ordered using Rosemount kit number 03154-5802-0001 (Qty. 10 per kit).
- (7) For reference, corresponding Curtiss-Wright part numbers are provided in the table below. Please always use the Rosemount model code when ordering.

<b>Rosemount Base Model Code</b>	<b>Curtiss-Wright Part Number</b>
QDC1XXXXXXXX	880701-XXX
QDC3XXXXXXXX	23066-XXX (see note 3)

*Page Intentionally Left Blank*

## REVISIONS

### Changes from Rev AA to Rev BA

Page (Old)	Page (New)	Changes
Cover, throughout	Cover, throughout	Updated document revision and implementation date, photos and figures to show the EGS QDC installed on Rosemount 3150 Series pressure transmitters, and formatting
Cover	Cover	Added a <i>Contents</i> section
2, 3	2 - 6	Updated <i>Product Description, Features and Benefits, Qualification Standards and Reports, Nuclear Specifications, Functional Specifications, Physical Specifications, and Dimensional Drawings</i> sections to include Generation 3 EGS QDC information
4	8	Updated <i>Ordering Information</i> table to a base model code ordering system and to include the Generation 3 EGS QDC

Standard Terms and Conditions of Sale can be found at:

[www.Emerson.com/en-us/pages/Terms-of-Use.aspx](http://www.Emerson.com/en-us/pages/Terms-of-Use.aspx)

The Emerson logo is a trademark and service mark of Emerson Electric Co.

Rosemount and Rosemount logotype are trademarks of Rosemount Inc.

All other marks are the property of their respective owners.

© 2016 Emerson Process Management. All rights reserved.

## Global Headquarters

### Emerson Process Management

Rosemount Nuclear Instruments, Inc.

8200 Market Blvd.

Chanhassen, MN 55317, USA

P +1 952 949-5210

F +1 952 949-5201

E [RNII.info@Emerson.com](mailto:RNII.info@Emerson.com)



Rosemount Nuclear Instruments, Inc. satisfies all obligations coming from legislation to harmonize product requirements in the European Union.