

Micro Motion® T-Series Coriolis Flow and Density Sensors



Safety and approval information

This Micro Motion product complies with all applicable European directives when properly installed in accordance with the instructions in this manual. Refer to the EC declaration of conformity for directives that apply to this product. The EC declaration of conformity, with all applicable European directives, and the complete ATEX Installation Drawings and Instructions are available on the internet at www.micromotion.com/atex or through your local Micro Motion support center.

Information affixed to equipment that complies with the Pressure Equipment Directive can be found on the internet at www.micromotion.com/documentation.

For hazardous installations in Europe, refer to standard EN 60079-14 if national standards do not apply.

Other information

Full product specifications can be found in the product data sheet. Troubleshooting information can be found in the transmitter configuration manual. Product data sheets and manuals are available from the Micro Motion web site at www.micromotion.com/documentation.

Return policy

Micro Motion procedures must be followed when returning equipment. These procedures ensure legal compliance with government transportation agencies and help provide a safe working environment for Micro Motion employees. Failure to follow Micro Motion procedures will result in your equipment being refused delivery.

Information on return procedures and forms is available on our web support system at www.micromotion.com, or by phoning the Micro Motion Customer Service department.

Micro Motion customer service

Location		Telephone number
U.S.A.		800-522-MASS (800-522-6277) (toll free)
Canada and Latin America		+1 303-527-5200 (U.S.A.)
Asia	Japan	3 5769-6803
	All other locations	+65 6777-8211 (Singapore)
Europe	U.K.	0870 240 1978 (toll-free)
	All other locations	+31 (0) 318 495 555 (The Netherlands)
Customers outside the U.S.A. can also send an email to flow.support@emerson.com .		

Contents

Chapter 1	Planning	1
1.1	Installation checklist	1
1.2	Best practices	2
1.3	Environmental limits	2
1.4	Recommendations for hygienic and self-draining applications	3
Chapter 2	Mounting	6
2.1	Mount the sensor	6
Chapter 3	Wiring	7
3.1	Options for wiring	7
3.2	Connect 4-wire cable	7
3.3	Connect 9-wire cable	10
Chapter 4	Grounding	11
Chapter 5	Supplementary information	12
5.1	Purge the sensor case	12

1 Planning

Topics covered in this chapter:

- [Installation checklist](#)
- [Best practices](#)
- [Environmental limits](#)
- [Recommendations for hygienic and self-draining applications](#)

1.1 Installation checklist

- Make sure that the hazardous area specified on the sensor approval tag is suitable for the environment in which the sensor is installed.
- Verify that the local ambient and process temperatures are within the limits of the sensor. See [Environmental limits](#).
- If your sensor has an integral transmitter, no wiring is required between the sensor and transmitter. Follow the wiring instructions in the transmitter installation manual for signal and power wiring.
- If your transmitter has remote-mounted electronics, follow the instructions in this manual for wiring between the sensor and the transmitter, and then follow the instructions in the transmitter installation manual for power and signal wiring.
- For the wiring between the sensor and the transmitter, consider maximum cable lengths (see [Table 1-1](#) and [Table 1-2](#)). The maximum distance between the sensor and transmitter depends on the cable type. For all types of wiring, Micro Motion recommends using Micro Motion cable.

Table 1-1: Maximum lengths for Micro Motion cable

Cable type	To transmitter	Maximum length
Micro Motion 9-wire	9739 MVD transmitter	1000 ft (300 m)
	All other MVD transmitters	60 ft (20 m)
Micro Motion 4-wire	All 4-wire MVD transmitters	1000 ft (300 m)

Table 1-2: Maximum lengths for user-supplied 4-wire cable

Wire function	Wire size	Maximum length
Power (VDC)	22 AWG (0,35 mm ²)	300 ft (90 m)
	20 AWG (0,5 mm ²)	500 ft (150 m)
	18 AWG (0,8 mm ²)	1000 ft (300 m)
Signal (RS-485)	22 AWG (0,35 mm ²) or larger	1000 ft (300 m)

- The sensor will work in any orientation as long as the flow tube remains full of process fluid.
- Install the sensor so that the flow direction arrow on the sensor matches the actual forward flow of the process.

1.2 Best practices

The following information can help you get the most from your sensor.

- There are no pipe run requirements for Micro Motion sensors. Straight runs of pipe upstream or downstream are unnecessary.
- If the sensor is installed in a vertical pipeline, liquids and slurries should flow upward through the sensor. Gases may flow upward or downward.
- Keep the sensor tube full of process fluid.
- For halting flow through the sensor with a single valve, install the valve downstream from the sensor.
- Minimize bending and torsional stress on the meter. Do not use the meter to align misaligned piping.
- The sensor does not require external supports. The flanges will support the sensor in any orientation.

1.3 Environmental limits

See [Figure 1-1](#) for the ambient and process temperature limits of the sensor.

Figure 1-1: Environmental limits for T-Series sensors

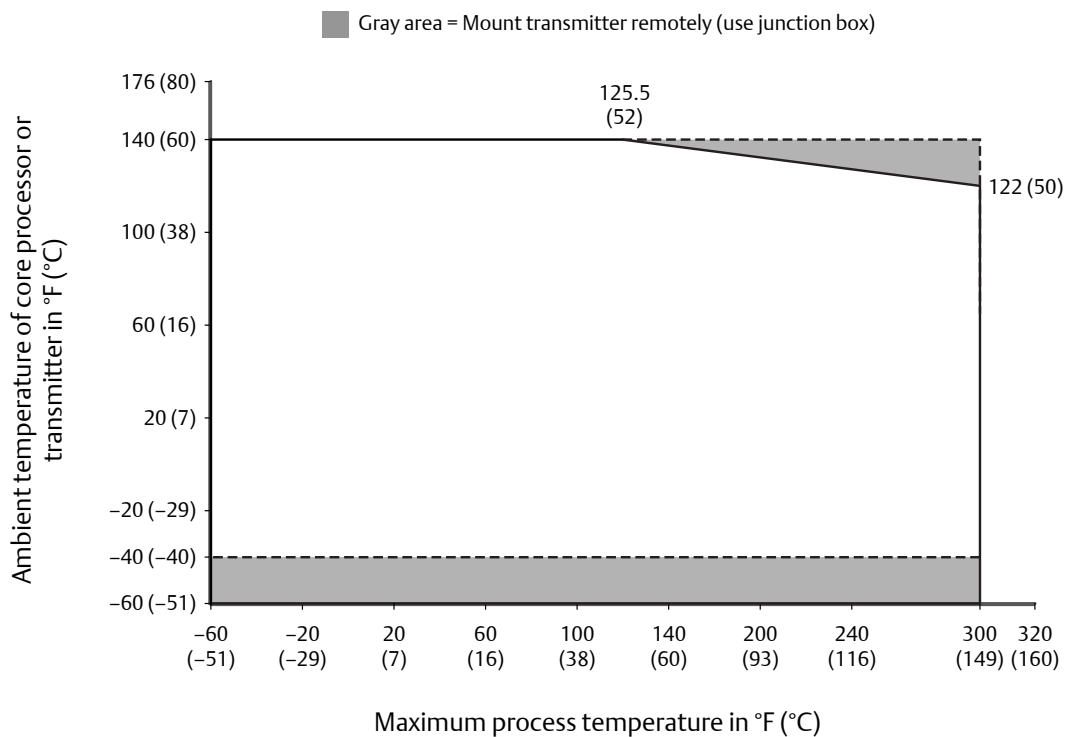

Notes

- When ambient temperature is below -40°F (-40°C), a core processor or transmitter must be heated to bring its local ambient temperature to between -40°F (-40°C) and $+140^{\circ}\text{F}$ ($+60^{\circ}\text{C}$). Long-term storage of electronics at ambient temperatures below -40°F (-40°C) is not recommended.
- Temperature limits may be further restricted by hazardous area approvals. Refer to the hazardous area approvals documentation shipped with the sensor or available from the Micro Motion web site (www.micromotion.com).
- The extended-electronics option allows the sensor case to be insulated without covering the transmitter, core processor, or junction box, but does not affect temperature ratings.
- For the purposes of selecting electronics options, this graph should be used only as a general guide. If your process conditions are close to the gray areas, it may be inappropriate to use electronics options other than a junction box. Consult with your Micro Motion representative.

1.4 Recommendations for hygienic and self-draining applications

For optimal cleanability and drainability:

- If possible, install the sensor in a vertical pipeline with the process fluid flowing upward through the sensor.

- The minimum angle of inclination of the sensor depends on the process fitting. See [Figure 1-2](#) and [Table 1-3](#).
- For clean-in-place (CIP) applications, Micro Motion recommends using the generally-accepted flow velocity of at least 1.5 m/s for cleaning the sensor.
- If the process piping must be larger than the sensor, eccentric reducers may be used to ensure full drainability. In this case, the process end connections for the piping and sensor must be the same size. See [Figure 1-3](#).

Note

As part of the cleaning process, skid-based systems may be purged with nitrogen at the end of the cleaning cycle. When using eccentric reducers, it is possible to trap gas in the section of process piping adjacent to the reducer. Sensor performance can be impacted by intermittent flow of the captured gas in a liquid fluid stream.

- The gap between the electronics housing and sensor body should be inspected periodically. Manually clean this gap when necessary.

Figure 1-2: Sensor inclination

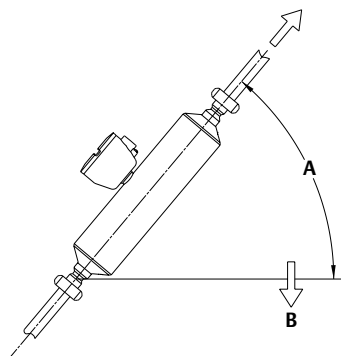

- A. Angle of inclination
- B. Direction of gravity

Table 1-3: Minimum angle of inclination

Model	Fitting code	Description	Min. angle
T025F, T025T	621	1/2-inch Tri-clamp compatible sanitary clamp	47°
	670	DN10 DIN 11851 sanitary coupling	47°
	671	DN15 DIN 11851 sanitary coupling	47°
	676	DN15 DIN 11864-1A sanitary coupling	47°
T050F, T050T	621	1/2-inch Tri-clamp compatible sanitary clamp	0°
	671	DN15 DIN 11851 sanitary coupling	47°
	676	DN15 DIN 11864-1A sanitary coupling	47°
T075F, T075T	622	3/4-inch Tri-clamp compatible sanitary clamp	0°
	623	1-inch Tri-clamp compatible sanitary clamp	47°

Table 1-3: Minimum angle of inclination (continued)

Model	Fitting code	Description	Min. angle
	662	DN25 ISO 2853 (IDF) sanitary coupling	47°
	672	DN25 DIN 11851 sanitary coupling	47°
	677	DN25 DIN 11864-1A sanitary coupling	47°
	692	DN25 SMS 1145 sanitary coupling	32°
T100F, T100T	623	1-inch Tri-clamp compatible sanitary clamp	0°
	624	1 1/2-inch Tri-clamp compatible sanitary clamp	46°
	672	DN25 DIN 11851 sanitary coupling	0°
	677	DN25 DIN 11864-1A sanitary coupling	0°
T150F, T150T	624	1 1/2-inch Tri-clamp compatible sanitary clamp	0°
	625	2-inch Tri-clamp compatible sanitary clamp	46°
	663	DN51 ISO 2853 (IDF) sanitary coupling	47°
	673	DN40 DIN 11851 sanitary coupling	0°
	674	DN50 DIN 11851 sanitary coupling	47°
	678	DN50 DIN 11864-1A sanitary coupling	47°
	693	DN51 SMS 1145 sanitary coupling	32°

Figure 1-3: Eccentric reducer

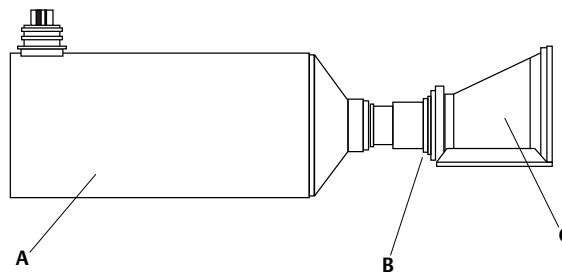

- A. Sensor case
- B. Process end connection is the same size as the sensor connection
- C. Eccentric reducer

2 Mounting

2.1 Mount the sensor

Use your common practices to minimize torque and bending load on process connections.

Tip

To reduce the risk of condensation or excessive moisture, the conduit opening should not point upward (if possible). The conduit opening of the junction box or core processor can be rotated freely to facilitate wiring.

Procedure

Mount the sensor in the pipeline (see [Figure 2-1](#)).

Figure 2-1: Mounting the sensor

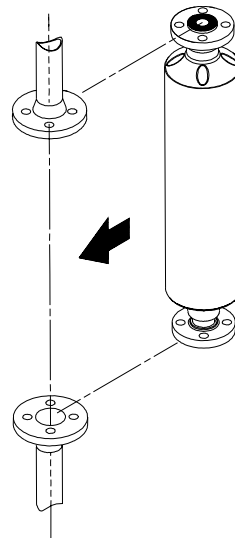
**Notes**

- Do not use the sensor to support the piping.
 - The sensor does not require external supports. The flanges will support the sensor in any orientation.
-

⚠ CAUTION!

Do not lift the sensor by the electronics or purge connections. Lifting the sensor by the electronics or purge connections can damage the device.

3 Wiring

Topics covered in this chapter:

- [Options for wiring](#)
- [Connect 4-wire cable](#)
- [Connect 9-wire cable](#)

3.1 Options for wiring

The wiring procedure you follow depends on which electronics option you have.

See [Table 3-1](#) for the wiring options for each sensor electronics option.

Table 3-1: Wiring procedures by electronics option

Electronics option	Wiring procedure
Integral transmitter	No wiring required between sensor and transmitter. See the transmitter installation manual for wiring the power and signal cable to the transmitter.
MVD™ Direct Connect™	No transmitter to wire. See the MVD Direct Connect manual for wiring the power and signal cable between the sensor and the direct host.
Core processor	See Connect 4-wire cable .
Junction box	See Connect 9-wire cable .

CAUTION!

Make sure the hazardous area specified on the sensor approval tag is suitable for the environment in which the sensor will be installed. Failure to comply with the requirements for intrinsic safety in a hazardous area could result in an explosion.

CAUTION!

Fully close and tighten all housing covers and conduit openings. Improperly sealed housings can expose electronics to moisture, which can cause measurement error or flowmeter failure. Inspect and grease all gaskets and O-rings.

3.2 Connect 4-wire cable

Step 1: Cable preparation

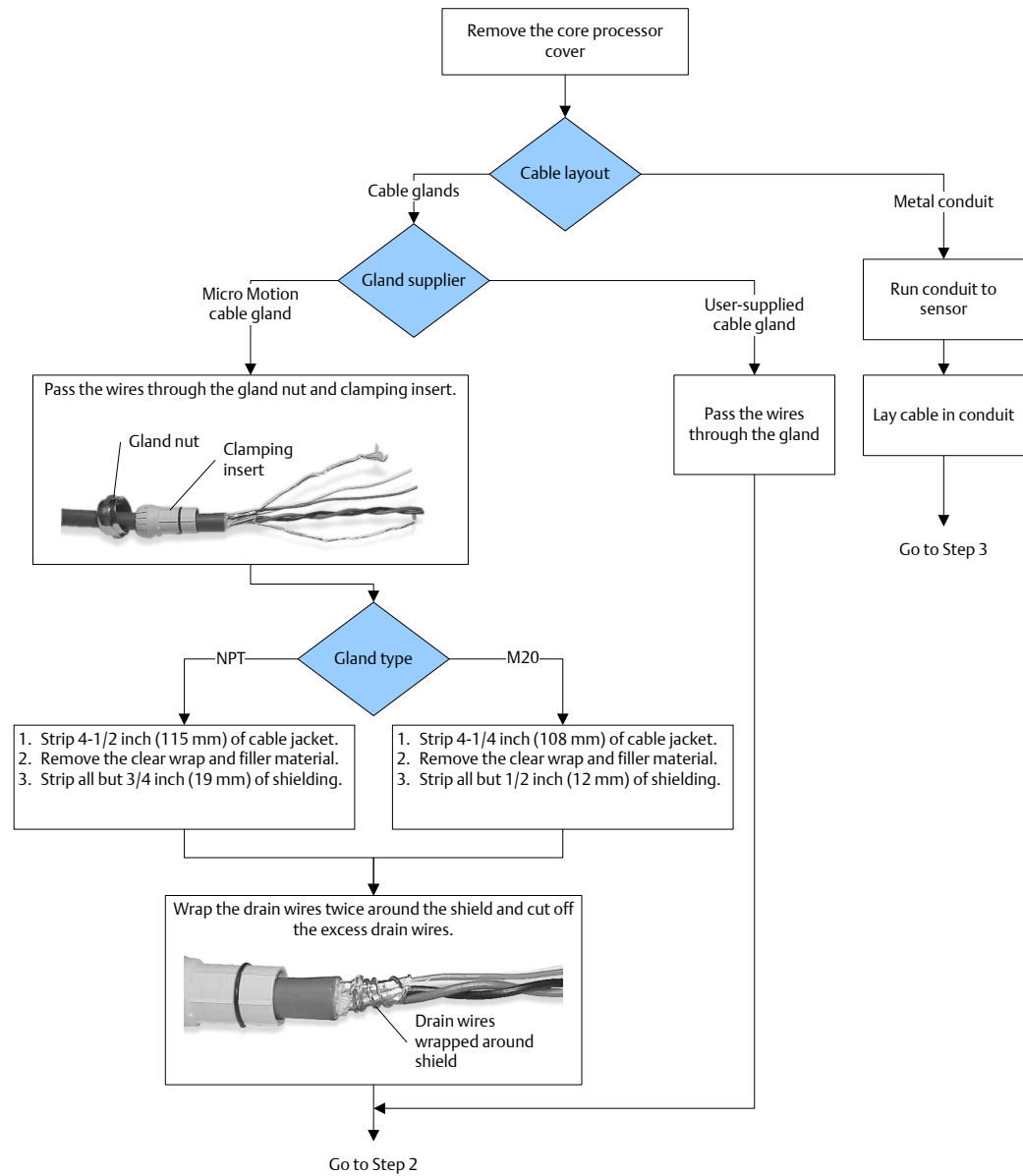

Step 2: Shield termination

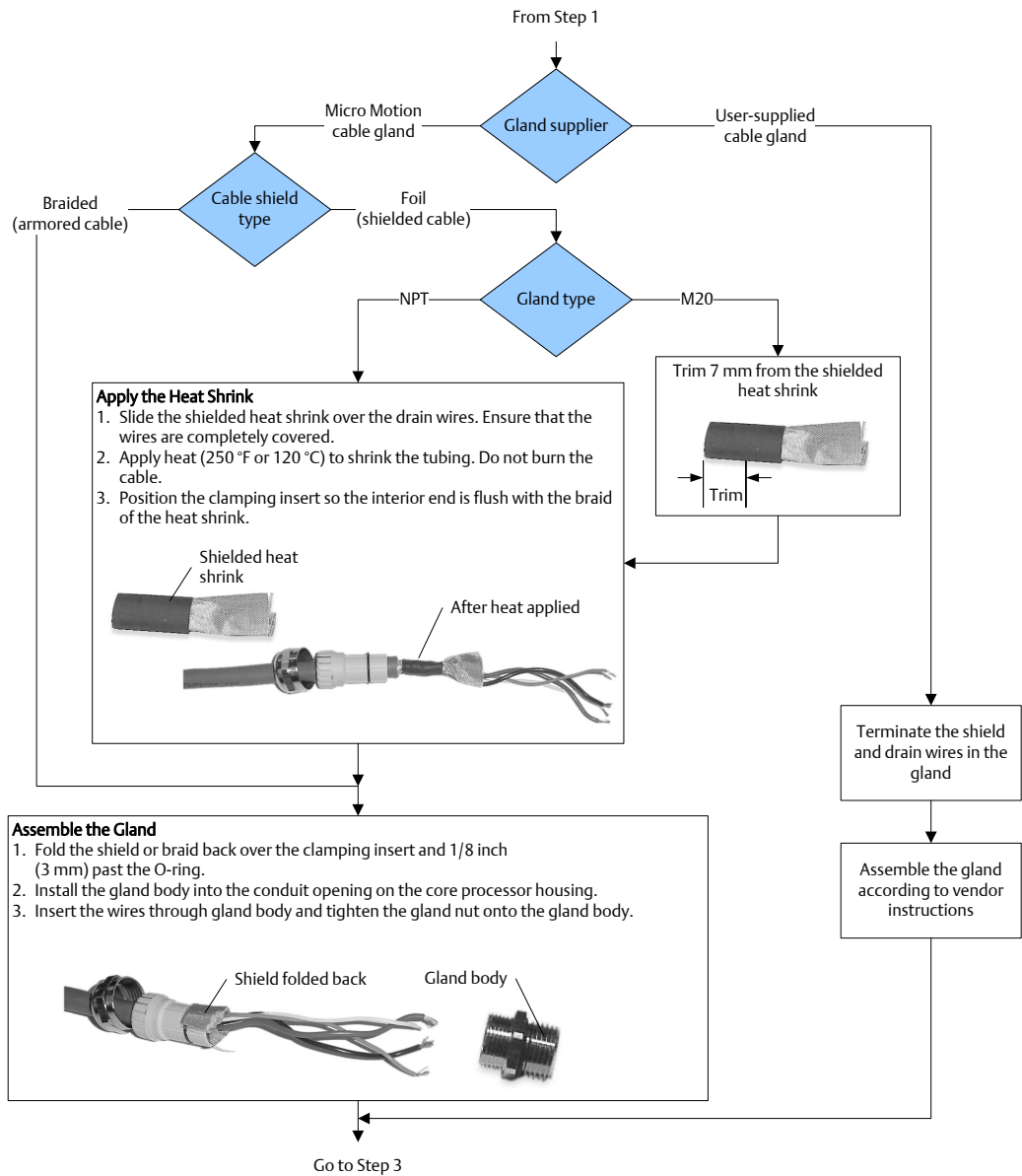

Step 3: Terminal connections

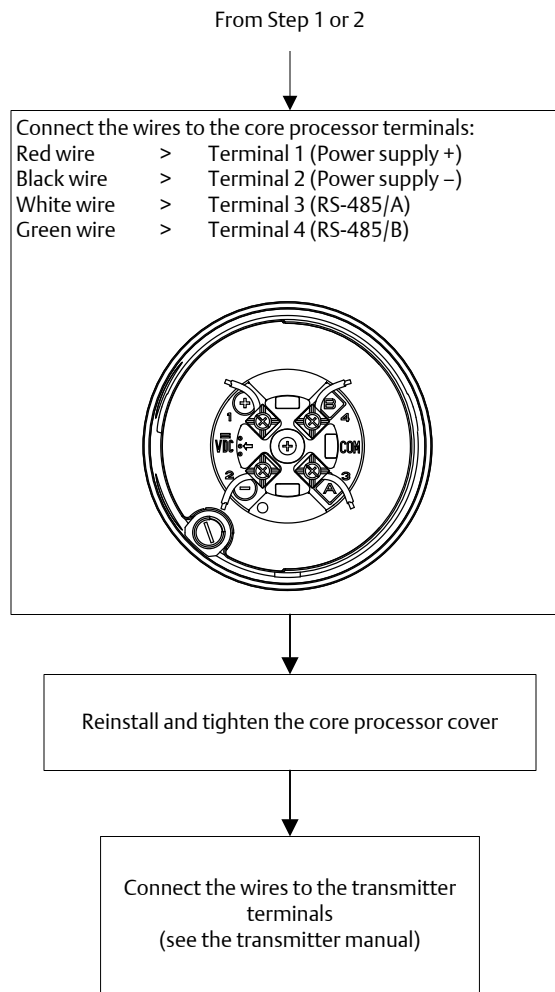

3.3 Connect 9-wire cable

1. Prepare and install the cable according to the instructions in the *Micro Motion 9-Wire Flowmeter Cable Preparation and Installation Guide*.
2. Insert the stripped ends of the individual wires into the terminal blocks. Ensure that no bare wires remain exposed.
3. Match the wires color for color. For wiring at the transmitter or remote core processor, refer to the transmitter documentation.
4. Tighten the screws to hold the wires in place.
5. Ensure integrity of gaskets, then tightly close and seal the junction box cover and all housing covers on the transmitter or core processor.
6. Refer to the transmitter installation manual for signal and power wiring instructions.

4 Grounding

The sensor must be grounded according to the standards that are applicable at the site. The customer is responsible for knowing and complying with all applicable standards.

Prerequisites

Micro Motion suggests the following guides for grounding practices:

- In Europe, IEC 79-14 is applicable to most installations, in particular Sections 12.2.2.3 and 12.2.2.4.
- In the U.S.A. and Canada, ISA 12.06.01 Part 1 provides examples with associated applications and requirements.

If no external standards are applicable, follow these guidelines to ground the sensor:

- Use copper wire, 14 AWG (2,0 mm²) or larger wire size.
- Keep all ground leads as short as possible, less than 1 Ω impedance.
- Connect ground leads directly to earth, or follow plant standards.

CAUTION!

Ground the flowmeter to earth, or follow ground network requirements for the facility. Improper grounding can cause measurement error.

Procedure

Check the joints in the pipeline.

- If the joints in the pipeline are ground-bonded, the sensor is automatically grounded and no further action is necessary (unless required by local code).
- If the joints in the pipeline are not grounded, connect a ground wire to the grounding screw located on the sensor electronics.

Tip

The sensor electronics may be a transmitter, core processor, or junction box. The grounding screw may be internal or external.

5 Supplementary information

5.1 Purge the sensor case

If the sensor has purge fittings, they should remain sealed at all times. After a purge plug has been removed, the sensor case should be purged with argon or nitrogen and resealed.

Purging the case protects internal components. The sensor is purged of all oxygen and sealed at the factory. If the purge plugs are never removed, it is not necessary to purge or re-seal the sensor. For more information, contact Micro Motion Customer Service.

If a purge plug is removed from the sensor case, it will be necessary to repurge the case.

CAUTION!

Take all necessary precautions when removing purge plugs. Removing a purge plug compromises the secondary containment of the sensor and could expose the user to process fluid.

CAUTION!

Improper pressurization of the sensor case could result in personal injury. Removing a purge plug will require the sensor case to be repurged with a dry inert gas. Follow all instructions provided in the case purging procedure.

Prerequisites

Make sure the following are available before beginning the purge procedure:

- Teflon[®] tape
- Argon or nitrogen gas sufficient to purge the sensor case

Procedure

1. Shut down the process, or set control devices for manual operation. Before performing the case purging procedure, shut down the process or set the control devices for manual operation. Performing the purge procedure while the flowmeter is operating could affect measurement accuracy, resulting in inaccurate flow signals.
2. Remove both purge plugs from the sensor case. If purge lines are being used, open the valve in the purge lines.
3. Prepare the purge plugs for reinstallation by wrapping them with 3–5 turns of Teflon tape.
4. Connect the supply of nitrogen or argon gas to the inlet purge connection or open inlet purge line. Leave the outlet connection open.
 - Exercise caution to avoid introducing dirt, moisture, rust, or other contaminants into the sensor case.

- If the purge gas is heavier than air (such as argon), locate the inlet lower than the outlet, so that the purge gas will displace air from bottom to top.
 - If the purge gas is lighter than air (such as nitrogen), locate the inlet higher than the outlet, so that the purge gas will displace air from top to bottom.
5. Make sure that there is a tight seal between the inlet connection and sensor case, so that air cannot be drawn by suction into the case or purge line during the purging process.
 6. Run purge gas through the sensor.

The purge time is the amount of time required for full exchange of atmosphere to inert gas. The larger the line size, the greater amount of time is required to purge the case. See [Table 5-1](#). If purge lines are being used, increase the purge time to fill the additional volume of the purge line.

Note

Keep the purge gas pressure below 30 psig (2 bar).

Table 5-1: Purge time

Sensor model	Purge rate, in ft ³ /hr (l/h)	Time, in minutes
T025	20 (566)	1
T050	20 (566)	1
T075	20 (566)	3
T100	20 (566)	5
T150	20 (566)	10

7. At the appropriate time, shut off the gas supply, then immediately seal the purge outlet and inlet connections with the purge plugs.

Note

Avoid pressurizing the sensor case. If pressure inside the case elevates above atmospheric pressure during operation, the flowmeter density calibration will be inaccurate.

8. Make sure that the purge fitting seals are tight so that air cannot be drawn by suction into the sensor case.



20002172

Rev BA

2010

Micro Motion Inc. USA

Worldwide Headquarters
7070 Winchester Circle
Boulder, Colorado 80301
T +1 303-527-5200
T +1 800-522-6277
F +1 303-530-8459
www.micromotion.com

Micro Motion Europe

Emerson Process Management
Neonstraat 1
6718 WX Ede
The Netherlands
T +31 (0) 318 495 555
F +31 (0) 318 495 556
www.micromotion.nl

Micro Motion Asia

Emerson Process Management
1 Pandan Crescent
Singapore 128461
Republic of Singapore
T +65 6777-8211
F +65 6770-8003

Micro Motion United Kingdom

Emerson Process Management Limited
Horsfield Way
Bredbury Industrial Estate
Stockport SK6 2SU U.K.
T +44 0870 240 1978
F +44 0800 966 181

Micro Motion Japan

Emerson Process Management
1-2-5, Higashi Shinagawa
Shinagawa-ku
Tokyo 140-0002 Japan
T +81 3 5769-6803
F +81 3 5769-6844

©2010 Micro Motion, Inc. All rights reserved.

The Emerson logo is a trademark and service mark of Emerson Electric Co. Micro Motion, ELITE, ProLink, MVD and MVD Direct Connect marks are marks of one of the Emerson Process Management family of companies. All other marks are property of their respective owners.

