

20 to 40 Ton ZP*KC and ZR*KC Copeland Scroll™ Air Conditioning Compressors





TABLE OF CONTENTS

<u>Section</u>	<u>Page</u>	<u>Section</u>	<u>Page</u>
Safety			
Safety Instructions	2	Application Tests	
Safety Icon Explanation	2	Application Test Summary	11
Instructions Pertaining to Risk of Electrical Shock, Fire, or Injury to Persons	3	Assembly Line Procedures	
Safety Statements.....	3	Compressor Handling	12
Introduction			
Nomenclature.....	4	Mounting	12
Application Considerations			
Operating Envelope	4	Suction & Discharge Fittings.....	12
Internal Pressure Relief (IPR) Valve	4	Assembly Line Brazing Procedure.....	12
Discharge Temperature Protection	5	Unbrazing System Components	12
High Pressure Control.....	5	Pressure Testing	13
Low Pressure Control	5	Assembly Line System Charging Procedures.....	13
Shut Down Device	5	Electrical Connections	13
Discharge Check Valve.....	5	Hipot Testing	13
Shell Temperature.....	5	Tandem Assembly.....	13
Compressor Cycling.....	5	Service Procedures	
Long Pipe Lengths / High Refrigerant Charge	5	Field Replacement	14
Suction and Discharge Fittings	6	Mounting	14
System Tubing Stress	6	Oil Removal	14
Accumulators	6	Electrical	14
Off Cycle Migration Control.....	6	Module	14
Crankcase Heat	6	Compressor Replacement after a Motor Burn	14
Pump Down Cycle	6	Manifolded Compressor Replacement.....	14
Pump Out Cycle.....	7	Start-Up of a New or Replacement Compressor	15
Reversing Valves	7	Field Troubleshooting Kriwan Module.....	15
Contaminant Control.....	7	Field Troubleshooting CoreSense Module.....	16
Oil Type	7	Copeland Scroll Compressor Functional Check	16
Three Phase Electrical Phasing	8	Refrigerant Retrofits.....	17
Power Factor Correction	8	Figures & Tables	
Soft Starters	8	Nomenclature.....	18
Motor Overload Protection	8	Operating Envelopes	19
Motor Overload Protection Specs.....	9	Suction Tube Brazing.....	20
Manifolded Compressors	9	Crankcase Heater Location	20
Manifolded Applications	9	Terminal Box Wiring Diagram	21
Variable Speed Operation			
Introduction	10	Typical Rotalock Connected Tandem w/TPTL Oil Manifold	22
Performance	10	Typical Braze Connected Tandem w/OEL Oil Manifold ..	22
Operating Envelope	10	Typical Braze Connected Trio w/ TPTL Oil Manifold....	23
Drive Selection.....	10	Drive Output - Frequency vs. Voltage	23
Electrical Requirements	10	Torque Values	24
Autotuning.....	11	Refrigerant Charge Limits.....	24
Starting and Ramp Up	11	Compressor Accessories	25
Stopping.....	11	Tandem Quick Reference Guide.....	26
Vibration.....	11	Trio Quick Reference Guide.....	27
Oil Recovery Cycle	11	Protector Specifications	28
Variable Speed Manifolded Applications.....	11	CoreSense LED Flash Code Information.....	29-30
		Control Techniques Drive Selections	31





Safety Instructions

Copeland Scroll[™] compressors are manufactured according to the latest U.S. and European Safety Standards. Particular emphasis has been placed on the user's safety. Safety icons are explained below and safety instructions applicable to the products in this bulletin are grouped on Page 3. These instructions should be retained throughout the lifetime of the compressor. **You are strongly advised to follow these safety instructions.**

Safety Icon Explanation

	DANGER indicates a hazardous situation which, if not avoided, will result in death or serious injury.
	WARNING indicates a hazardous situation which, if not avoided, could result in death or serious injury.
	CAUTION, used with the safety alert symbol, indicates a hazardous situation which, if not avoided, could result in minor or moderate injury.
	NOTICE is used to address practices not related to personal injury.
	CAUTION, without the safety alert symbol, is used to address practices not related to personal injury.

Instructions Pertaining to Risk of Electrical Shock, Fire, or Injury to Persons

 <p>WARNING</p>	<p>ELECTRICAL SHOCK HAZARD</p> <ul style="list-style-type: none"> • Failure to follow these warnings could result in serious personal injury • Disconnect and lock out power before servicing. • Use compressor with grounded system only. • Refer to original equipment wiring diagrams. • Electrical connections must be made by qualified electrical personnel.
 <p>WARNING</p>	<p>PRESSURIZED SYSTEM HAZARD</p> <ul style="list-style-type: none"> • Failure to follow these warnings could result in serious personal injury • System contains refrigerant and oil under pressure. • Remove refrigerant from both the high and low compressor side before removing compressor. • Never install a system and leave it unattended when it has no charge, a holding charge, or with the service valves closed without electrically locking out the system. • Use only approved refrigerants and refrigeration oils. • Personal safety equipment must be used.
 <p>WARNING</p>	<p>BURN HAZARD</p> <ul style="list-style-type: none"> • Failure to follow these warnings could result in serious personal injury or property damage. • Use caution when brazing system components. • Ensure that materials and wiring do not touch high temperature areas of the compressor. • Personal safety equipment must be used.
 <p>CAUTION</p>	<p>COMPRESSOR HANDLING</p> <ul style="list-style-type: none"> • Failure to follow these warnings could result in personal injury or property damage. • Use the appropriate lifting devices to move compressors. • Personal safety equipment must be used.

Safety Statements

- Refrigerant compressors must be employed only for their intended use.
- Only qualified and authorized HVAC or refrigeration personnel are permitted to install, commission and maintain this equipment.
- Electrical connections must be made by qualified electrical personnel.
- All valid standards and codes for installing, servicing, and maintaining electrical and refrigeration equipment must be observed.

INTRODUCTION

The 20 to 40 ton ZR*KC and ZP*KC Copeland Scroll™ compressors are designed for a variety of commercial air conditioning and chiller applications. This bulletin describes the operating characteristics, design features, and application requirements for these models.

The ZR*KC and ZP*KC scrolls outlined in this bulletin range in size from 250,000 to 380,000 Btu/hr (73.3 to 111.4 kW) and 235,000 to 485,000 (68.9 to 142.1 kW) respectively. These models include all of the standard 50 and 60 Hertz three phase voltages. Compressors in this size range include a number of features outlined in **Table 1** below.

Nomenclature

The model numbers of the Copeland Scroll compressors include the approximate nominal 60 Hz capacity at standard operating conditions. An example would be the ZP236KCE-TED, which has 236,000 Btu/hr (69.1kW) cooling capacity at the AHRI high temperature air conditioning rating point when operated at 60 Hz. Note that the same compressor will have approximately 5/6 of this capacity or 196,000 Btu/hr (57.4kW) when operated at 50 Hz. See **Figure 1** for more information regarding nomenclature.

APPLICATION CONSIDERATIONS

The following application guidelines should be considered during the design of a system using ZR*KC and ZP*KC scroll compressors. Some of this information is recommended, whereas other guidelines must be followed. The Application Engineering department will always welcome suggestions that will help improve these types of documents.

Operating Envelope

Figure 2 illustrates the operating envelope for the ZR*KC and ZP*KC compressors with R-22/R-407C/R-134a and R-410A respectively. The operating envelopes represent operating conditions with 20F°

(11K) superheat in the return gas. The steady-state operating condition of the compressor must remain inside the prescribed operating envelope. Excursions outside of the envelope should be brief and infrequent. Use of refrigerants other than R-22, R-407C, or R-134a with ZR*KCE and R-410A with ZP*KCE voids the compressor UL recognition.

Figure 2 also illustrates the operating envelope for the expanded frequency range of the 20 to 40 Copeland Scroll compressors. Please note that the envelope is truncated versus the standard 50/60 Hertz operating envelope. In addition, please note the restrictions on operating frequency/speed within the envelope. For more information on the application of the expanded frequency range compressors please refer to the section **Variable Speed Operation**.

Internal Pressure Relief (IPR) Valve



A high pressure control must be used in all applications.

The 20 to 40 ton Copeland Scroll compressors do not have internal pressure relief valves. **To avoid abnormally high operating pressures, a high pressure control must be used in all applications.**

If any type of discharge line shut-off valve is used, the high pressure control must be installed between the compressor discharge fitting and the valve. Compressors with rotalock discharge fittings have a connection on the rotalock fitting for the high pressure cut-out switch connection.

ASHRAE Standard 15 and UL 984/60335-2-34 requires a system pressure relief valve when the compressor displacement is greater than 50 CFM. The floating seal in the compressor effectively acts as a pressure-relief device during blocked discharge conditions. Please refer to UL File SA2337 to reference UL's acceptance of this method.

Table 1 – 20 to 40 Ton Copeland Scroll™ Family Features

Model	Refrigerant	Motor Protection	Communications ²	Tandem/Trio Manifolder Applications	Electrical Frequency Range
ZR250-380KCE-TW ¹	R-407C, R-22, R-134a	Kriwan	No	Yes	35-75 Hertz
ZR250-380KCE-TE ¹	R-407C, R-22, R-134a	CoreSense™	Yes	Yes	35-75 Hertz
ZP235-485KCE-TW ¹	R-410A	Kriwan	No	Yes	35-75 Hertz
ZP236-485KCE-TE ¹	R-410A	CoreSense	Yes	Yes	35-75 Hertz

¹Last Character In Voltage Code (5, C, D, E, or 7)

² Modbus via RS485

Discharge Temperature Protection

High discharge temperature protection is provided by a thermistor probe in the discharge plenum of the scroll. Compressors with TW* motor nomenclature use a positive temperature coefficient (PTC) thermistor and compressors with TE* motor nomenclature use a negative temperature coefficient (NTC) thermistor. In either case the module M1-M2 contacts are opened if the internal discharge temperature exceeds safe limits. Discharge temperature data are stored in the CoreSense module and can be made available to a system controller.

High Pressure Control

A high pressure cut-out control must be used in all applications. The maximum cut out setting is 425 psig (30 bar) for R-22, R-407C, and R-134a and 650 psig (45 bar) for R-410A. The high pressure control should have a manual reset feature for the highest level of system protection.

Low Pressure Control

A low pressure control is highly recommended for loss of charge protection and other system fault conditions that may result in very low evaporating temperatures. Even though these compressors have internal discharge temperature protection, loss of system charge will result in overheating and recycling of the motor overload protector. Prolonged operation in this manner could result in oil pump out and eventual bearing failure.

The low pressure cut-out setting will depend on the application type and minimum expected evaporating temperature. The low pressure cut-out should be selected to prevent compressor overheating and other system failure modes such as coil icing in air conditioning systems and frozen heat exchangers in chiller systems.

The minimum, recommended low pressure cut-out switch settings are:

Air conditioning and chiller:

55 psig/3.8 bar (R-410A), 25 psig/1.7 bar (R-22 & R-407C), and 10 psig/0.7 bar (R-134a)

Heat pumps:

20 psig/1.4 bar (R-410A), 10 psig/0.7 bar (R-22, R-407C, & R-134a)

Shut Down Device

All scrolls in this size range have floating valve technology to mitigate shut down noise. Since Copeland Scroll™ compressors are also excellent gas expanders, they may run backwards for a brief period after shutdown as the internal pressures equalize.

Discharge Check Valve

A spring assist, disk-type check valve in the discharge fitting of the compressor prevents the high pressure gas in the condenser from flowing back through the compressor after shutdown. Performance of the check valve for recycling pump down applications hasn't been evaluated at all pressure differentials. Low pressure differentials may result in unacceptable leak-back rates.

Shell Temperature



Compressor top cap temperatures can be very hot. Care must be taken to ensure that wiring or other materials which could be damaged by these temperatures do not come into contact with these potentially hot areas.

Compressor Cycling

There is no set answer to how often scroll compressors can be started and stopped in an hour, since it is highly dependent on system configuration. There is no minimum off time because Copeland Scroll compressors start unloaded, even if the system has unbalanced pressures. The most critical consideration is the minimum run time required to return oil to the compressor after startup. To establish the minimum run time, obtain a sample compressor equipped with a sight tube (available from Emerson) and install it in a system with the longest connecting lines and highest internal volume that the system may have. The minimum on time becomes the time required for oil lost during compressor startup to return to the compressor sump and restore a minimal oil level that will assure oil pick up through the crankshaft. **The minimum oil level required in the compressor is 1.5" (40 mm) below the center of the compressor sight-glass. The oil level should be checked with the compressor "off" to avoid the sump turbulence when the compressor is running.** Cycling the compressor for a shorter period than this, for instance to maintain very tight temperature control, will result in progressive loss of oil and damage to the compressor. CoreSense™ Communications provides a configurable short cycle protection feature.

Long Pipe Lengths / High Refrigerant Charge

Some systems may contain higher-than-normal refrigerant charges. Systems with large reheat coils, low ambient condenser flooding, or systems with multiple heat exchangers are among some system configurations that may require additional lubricant. Since the 20 to 40 ton scrolls have sight-glasses for oil level viewing, the oil level should always be checked during OEM assembly, field commissioning, and field servicing. An estimation of the amount of additional lubricant to add to the compressor(s) when the circuit charge exceeds 20 pounds of refrigerant is as follows:

Single compressor application: 0.5 fluid ounce of oil per pound of refrigerant

Tandem compressor application: 0.7 fluid ounce of oil per pound of refrigerant

Trio compressor application: 1.0 fluid ounce of oil per pound of refrigerant

The oil level must be carefully monitored during system development, and corrective action should be taken if the compressor oil level falls more than 1.5" (40 mm) below the center of the sight-glass. **The compressor oil level should be checked with the compressor "off" to avoid the sump turbulence when the compressor is running.**

These compressors are available to the OEM with a production sight-glass that can be used to determine the oil level in the compressor in the end-use application. These compressors are also available to the OEM with an oil Schrader fitting on the side of the compressor to add additional oil if needed because of long lengths of piping or high refrigerant charge. **No attempt should be made to increase the oil level in the sight-glass above the 3/4 full level. A high oil level is not sustainable in the compressor and the extra oil will be pumped out into the system causing a reduction in system efficiency and a higher-than-normal oil circulation rate.**

Suction and Discharge Fittings

20 to 40 ton Copeland Scroll™ compressors have copper plated steel suction and discharge or threaded rotalock fittings. See **Figure 3** for assembly line and field brazing recommendations and **Table 2** for rotalock torque requirements.

System Tubing Stress

System tubing should be designed to keep tubing stresses below 9.5 ksi (62 MPa), the endurance limit of copper tubing. Start, stop and running (resonance) cases should be evaluated.

Accumulators

The use of accumulators is very dependent on the application. The Copeland Scroll™ compressor's inherent ability to handle liquid refrigerant during occasional operating flood back situations makes the use of an accumulator unnecessary in most applications. In applications where uncontrolled flooding is common, an accumulator should be used to prevent excessive oil dilution and oil pump out.

Off-Cycle Migration Control

Excessive migration of refrigerant to the compressor during the off-cycle can result in oil pump-out on start up, excessive starting noise and vibration, bearing erosion, and broken scrolls if the hydraulic slugging pressure is high enough. For these reasons, off-cycle refrigerant migration must be minimized. The following three sections summarize off-cycle migration techniques.

Crankcase Heat

A crankcase heater is required when the system charge exceeds the values listed in **Table 3**. This requirement is independent of system type and configuration. **Table 4** lists Emerson crankcase heaters by part number and voltage. See **Figure 4** for the proper heater location on the compressor shell. **The crankcase heater must remain energized during compressor off cycles.**

The initial start-up in the field is a very critical period for any compressor because all load-bearing surfaces are new and require a short break-in period to carry high loads under adverse conditions. **The crankcase heater must be turned on a minimum of 12 hours prior to starting the compressor.** This will prevent oil dilution and bearing stress on initial start up.

To properly install the crankcase heater, the heater should be installed in the location illustrated in **Figure 4**. Tighten the clamp screw carefully, ensuring that the heater is uniformly tensioned along its entire length and that the circumference of the heater element is in complete contact with the compressor shell. It's important that the clamp screw is torqued to the range

of 20-25 in-lb (2.3-8 N-m) to ensure adequate contact and to prevent heater burnout. Never apply power to the heater in free air or before the heater is installed on the compressor to prevent overheating and burnout. **WARNING! Crankcase heaters must be properly grounded.**

Pump Down Cycle

Although not preferred, a recycling pump down cycle can be used to minimize off-cycle refrigerant migration to the compressor. The risk of a short cycling condition that can lead to oil pump out, excessive contactor wear, unnecessary energy use, and excessive low pressure cut-out switch cycles makes recycling pump down undesirable. If a pump down cycle is desired by the system designer, a one time pump down at the end of the cooling cycle is preferred over recycling pump down. In lieu of the pump down cycles mentioned above, simply closing a liquid line solenoid valve when the compressor cycles off is a good, simple, and cost effective method of minimizing off-cycle refrigerant migration.

Pump Out Cycle

A pump out cycle has been successfully used by some manufacturers of large rooftop units. After an extended off period, a typical pump out cycle will energize the compressor for up to one second followed by an off time of 5 to 20 seconds. This cycle is usually repeated a second time, the third time the compressor stays on for the cooling cycle.

If any of the above methods are employed, a crankcase heater must be used if the circuit charge amount exceeds the values listed in Table 3.

Reversing Valves

Since Copeland Scroll compressors have very high volumetric efficiency, their displacements are lower than those of comparable capacity reciprocating compressors. **CAUTION Reversing valve sizing must be within the guidelines of the valve manufacturer. Required pressure drop to ensure valve shifting must be measured throughout the operating range of the unit and compared to the valve manufacturer's data. Low ambient heating conditions with low flow rates and low pressure drop across the valve can result in a valve not shifting. This can result in a condition where the compressor appears to be not pumping (i.e. balanced pressures). It can also result in elevated compressor sound levels.** During

a defrost cycle, when the reversing valve abruptly changes the refrigerant flow direction, the suction and discharge pressures will go outside of the normal operating envelope. The sound that the compressor makes during this transition period is normal, and the duration of the sound will depend on the coil volume, outdoor ambient, and system charge level. The preferred method of mitigating defrost sound is to shut down the compressor for 20 to 30 seconds when the reversing valve changes position going into and coming out of the defrost cycle. This technique allows the system pressures to reach equilibrium without the compressor running. The additional start-stop cycles do not exceed the compressor design limits, but suction and discharge tubing design should be evaluated.

The reversing valve solenoid should be wired so that the valve does not reverse when the system is shut off by the operating thermostat in the heating or cooling mode. If the valve is allowed to reverse at system shutoff, suction and discharge pressures are reversed to the compressor. This results in pressures equalizing through the compressor which can cause the compressor to slowly rotate backwards until the pressures equalize. This condition does not affect compressor durability but can cause unexpected sound after the compressor is turned off.

Contaminant Control

Copeland Scroll™ compressors leave the factory with a miniscule amount of contaminants. Manufacturing processes have been designed to minimize the introduction of solid or liquid contaminants. Dehydration and purge processes ensure minimal moisture levels in the compressor, and continuous auditing of lubricant moisture levels ensures that moisture isn't inadvertently introduced into the compressor. During unit assembly and field servicing, compressors shouldn't be left open to the atmosphere for longer than 20 minutes.

It is generally accepted that system moisture levels should be maintained below 50 ppm. **A filter-drier is required on all POE lubricant systems to prevent solid particulate contamination, oil dielectric strength degradation, ice formation, oil hydrolysis, and metal corrosion.** It is the system designer's responsibility to make sure that the filter-drier is adequately sized to accommodate the contaminants from system manufacturing processes which leave solid or liquid contaminants in the evaporator coil, condenser coil, and interconnecting tubing plus any contaminants introduced during the field installation

process. Molecular sieve and activated alumina are two filter-drier materials designed to remove moisture and mitigate acid formation. A 100% molecular sieve filter can be used for maximum moisture capacity. A more conservative mix, such as 75% molecular sieve and 25% activated alumina, should be used for service applications.

Oil Type

Mineral oil is used in the ZR*KC compressors for R-22 applications. Polyolester (POE) oil is used in the ZR*KCE compressors for use with R-22, R-407C, and R-134a and in ZP*KCE compressors for use with R-410A. See the compressor nameplate for the original oil charge. A complete recharge should be approximately four fluid ounces (118 ml) less than the nameplate value.

If additional oil is needed in the field for POE applications, Copeland[™] Ultra 32-3MAF, Lubrizol Emkarate RL32-3MAF, Parker Emkarate RL32-3MAF/ (Virginia) LE32-3MAF, or Nu Calgon 4314-66 (Emkarate RL32-3MAF) should be used. Copeland[™] Ultra 22 CC, Hatcol EAL 22CC, and Mobil EAL Arctic 22 CC are acceptable alternatives.

If additional oil is needed in the field for mineral oil applications, Sonneborn Suniso 3GS or Chevron Texaco Capella WF32 should be used.

CAUTION POE must be handled carefully and the proper protective equipment (gloves, eye protection, etc.) must be used when handling POE lubricant. POE must not come into contact with any surface or material that might be harmed by POE, including without limitation, certain polymers (e.g. PVC/CPVC and polycarbonate).

Three Phase Scroll Compressor Electrical Phasing

NOTICE

Compressors that employ CoreSense technology have phase protection and will be locked out after one reverse phase event.

Copeland Scroll compressors, like several other types of compressors, will only compress in one rotational direction. Three phase compressors will rotate in either direction depending upon phasing of the power. Since there is a 50% chance of connecting power in such a way as to cause rotation in the reverse direction, **it is important to include notices and instructions in**

appropriate locations on the equipment to ensure that proper rotation direction is achieved when the system is installed and operated. Verification of proper rotation direction is made by observing that suction pressure drops and discharge pressure rises when the compressor is energized. Reverse rotation will result in no pressure differential as compared to normal values. A compressor running in reverse will sometimes make an abnormal sound.

There is no negative impact on durability caused by operating three phase Copeland Scroll[™] compressors in the reversed direction for a short period of time (under one hour). After a few minutes of reverse operation, the motor and scroll thermistor circuit will exceed the temperature trip point and the M1-M2 contacts will open, shutting off the compressor. If allowed to repeatedly restart and run in reverse without correcting the situation, the compressor bearings will be permanently damaged because of oil loss to the system. All three-phase scroll compressors are wired identically internally. As a result, once the correct phasing is determined for a specific system or installation, connecting properly phased power leads to the identified compressor electrical (Fusite[®]) terminals will maintain the proper rotational direction (see **Figure 5**).

Power Factor Correction

If power factor correction is necessary in the end-use application, please see **AE9-1249** for more information on this topic.

Soft Starters

Soft starters can be used with the 20 to 40 ton Copeland Scroll compressors to reduce inrush current. Soft starters should be selected in accordance with the soft starter manufacturer's recommendations, taking into consideration ambient temperature, number of starts per hour, and compressor amps. The maximum ramp up time should not exceed 3 seconds.

Motor Overload Protection



The Kriwan and CoreSense Communications modules are U.L. recognized safety devices and must be used with all compressors that have TW* and TE* electrical codes respectively.

Models with Electrical Code TE

Compressors with an "E" in the electrical code (i.e. ZP236KCE-TED) employ CoreSense[™]

Communications as the motor overload protection device. CoreSense Communications provides advanced diagnostics, protection, and communications that enhance compressor performance and reliability. For more information please refer to the CoreSense Communications application engineering bulletin, **AE8-1384**.

Models with Electrical Code TW

Models with a "W" in the electrical code (i.e. ZP285KCE-TWD) have a Kriwan motor overload system that consists of an external electronic control module connected to a chain of thermistors embedded in the motor windings and scroll discharge plenum. The module will trip and remain off for a minimum of 30 minutes if the motor or scroll temperature exceeds the maximum allowable temperature.

Note: Turning off power to the module will reset it immediately, however, if the fault is still present that caused the trip the module will lock out the compressor for another 30 minutes.

The module has a 30 minute time delay to allow the motor and scrolls to cool down after the temperature limit has been reached. **CAUTION Restarting the compressor sooner may cause a destructive temperature build up in the compressor.** For this reason, module power must never be switched off with the control circuit voltage. Since the compressor is dependent upon the contactor to disconnect it from power in case of a fault, the contactor must be selected in accordance with **AE10-1244**. The contactor must meet both the Rated Load Amps (RLA) and Locked Rotor Amps (LRA) specified for the compressor.

If the Kriwan module is applied in conjunction with a programmable logic controller (PLC), it is important that a minimum load is carried through the M1-M2 control circuit contacts. The minimum required current through the module relay contacts needs to be greater than 20 milliamps, but no more than 2.5 amps. If this minimum current is not maintained, long-term contact resistance of the relay may be compromised resulting in nuisance, unexplained trips. PLC operated control circuits may not always provide this minimum current. In these cases modifications to the PLC control circuit, or the addition of a relay, may be required.

Motor Overload Protection Specs

Table 7 summarizes the features and specifications

for Kriwan and CoreSense modules. Please see the **Field Troubleshooting** section for information on troubleshooting the Kriwan and CoreSense modules.

Manifolded Compressors

Tandem compressor assemblies are available for purchase from Emerson. In lieu of purchasing the assembled tandem, OEMs can purchase the manifold-ready compressors and perform the assembly in their factory. Trio compressor assemblies are not available for purchase from Emerson. However, trio compressor designs have been developed and qualified. Drawings of tandem and trio compressor assemblies are available from Emerson Climate Technologies by contacting your Application Engineer. **Tables 5 and 6** are quick reference guides to tandem and trio compressor assemblies respectively. Part numbers for manifolds and other service parts are available by contacting Application Engineering. **Figures 6, 7 and 8** show manifolded compressor assemblies. **NOTICE: Customers who choose to design and build their own manifolds for tandem and trio compressor assemblies are ultimately responsible for the reliability of those manifold sets.**

The suction manifold is usually a symmetrical layout with the design intent of equal pressure drop to each compressor in the tandem or trio set. A straight length of pipe 18" (450 mm) or longer is required directly upstream of the suction manifold connection for all tandems and trios. The straight pipe serves as a flow straightener to make the flow as uniform as possible going into the suction manifold. Some tandem and trio assemblies use flow washers to assist with oil balancing between the compressors. Please refer to **Tables 5 and 6** for a complete list of all tandem and trios and required flow washers. For reference, refer to **Figures 6, 7, and 8** for compressor A-B-C identification in tandem and trio configurations. Compressor "A" is always on the left side of the assembly, when looking at the assembly from the terminal box side of the compressors.

The discharge manifold is the less critical of the two manifolds in terms of pressure drop and flow. Low pipe stress and reliability are its critical design characteristics. Manifolded options with bidirectional discharge manifolds will obviously need to have one of the outlets capped by the OEM or end-user. The overall length of the cap fitting shouldn't exceed 3" (7.6 cm). If the bidirectional manifold is clamped to the unit to provide discharge line stability, the clamp must

be installed at least 15" (38 cm) downstream of the manifold. Clamping in this method will provide some flexibility between the manifold and the clamp.

Two different oil balancing techniques are used with tandems in this family of compressors – two-phase tandem line (TPTL) and oil equalization line (OEL). For trio assemblies, only the TPTL design has been qualified. The TPTL design is a larger diameter pipe connecting the oil sumps of the individual compressors allowing both gas and oil to flow between the compressors at the same time. To install the TPTL, the individual sight-glasses on each compressor must be removed to allow the TPTL to screw on to the sight-glass fitting on the compressors. A sight-glass is installed on the TPTL to view the presence of oil (see **Figure 6**).

The OEL design is a 5/8" (16 mm) copper tube connecting the oil sumps of the individual compressors allowing the flow of oil between the compressor sumps. To install the OEL, the oil drain Schrader fitting on each compressor must be removed so the OEL line can be screwed on to the individual rotalock oil fittings (see **Tandem Assembly** section). The OEL has an oil drain Schrader fitting on the 5/8" OEL tube for adding/removing oil (see **Figure 7**). The OEL design allows the individual oil levels in each compressor to be viewed, which isn't possible with the TPTL.

Manifolded Applications

NOTICE

Manifolded compressor designs employ a passive oil management system. All system designs must be tested by the OEM to ensure that the passive design will provide adequate oil balancing between the compressors in the manifolded set under all operating conditions. If adequate oil balancing can't be demonstrated, an active oil management system must be used.

Manifolded compressors follow the same application guidelines as single compressors outlined in this bulletin. The refrigerant charge limit for tandem compressors is shown in **Table 3**. A tandem circuit with a charge over this limit must have crankcase heaters applied to both compressors.

The direction of the suction gas flow into the 18" (457 mm) straight pipe, directly upstream of the suction manifold, is critical for trio assemblies. The direction of flow is noted for each trio assembly in **Table 6** and on

the individual trio assembly drawings. **The direction of flow is critical for oil balancing between the compressors and the noted direction of flow must be followed.**

Oil levels in the individual sight-glasses will vary, depending on whether one or more compressors in the manifolded set are operating and if the manifolded set is made up of equal or unequal compressor capacities. **Because of the unequal oil levels that can exist, oil levels should be viewed with the compressors off to allow the oil level to stabilize between the compressor sumps.** With the compressors off, oil should be visible in the individual compressor sight-glasses when the OEL is used, or in the sight-glass on the TPTL. If oil is not visible, additional oil should be added to the system. **The above procedure is extremely important during the unit commissioning process in the field and must be performed. Failure to add oil to the system to account for large refrigerant charges and large internal surface areas can result in compressor failure.**

Suction and discharge tandem manifolds are not designed to support system piping. Support means must be provided by the system designer to support suction and discharge lines so that stress is not placed on the manifolds.

Compressors in a manifolded set must be started and stopped sequentially to keep manifold stresses as low as possible.

Please consult with Application Engineering during the development of systems with trio compressor assemblies. Trio compressor assemblies are sensitive to system operating conditions and configurations which will affect oil balancing. Trio compressor assemblies must be qualified for each application.

VARIABLE SPEED OPERATION

Introduction

The 20 to 40 ton Copeland Scroll compressors described in this bulletin are qualified for a speed range of 2100 to 4500 RPM, which corresponds to an electrical input frequency of 35 to 75 Hertz.

Performance

Ten coefficients are available for calculating performance. Evaporating and condensing temperature

are the terms for the ten coefficient equation to calculate mass flow, power, and capacity. Twenty coefficients are also available for calculating performance. Evaporating and condensing temperature and speed are the terms of the equation. The coefficients are for the compressor only and do not account for the drive. These coefficients are available by contacting Application Engineering.

Operating Envelope

The variable speed operating envelope is shown in **Figure 2**. Please note that the 35 to 75 Hertz (2100 to 4500 RPM) range does not apply to the entire envelope. The system controller must have the ability to keep the operating condition inside of the prescribed operating envelope.

Drive Selection

A third party drive must be selected and sourced separately for the compressor. For convenience, a list of Emerson Control Techniques drives is listed in **Table 9**. These preselected drives offer a variety of I/O for drive/compressor control. For more information on Emerson Control Techniques drives please visit <http://www.emersonindustrial.com/en-US/controltechniques/industries/hvac/Pages/heating-ventilation-air-conditioning-refrigeration.aspx> or call 800-367-8067 for technical assistance. Registration is not required to use the website and users can download manuals, user guides, drawings, software, and other drive information.

Electrical Requirements

The drive must be sized to accommodate the maximum expected running amps of the compressor. The Control Techniques Drives in **Table 9** are selected based on the maximum current published in the operating envelope at rated voltage. For operation throughout the operating envelope at +/-10% voltage variation the drive should be selected based on the compressor maximum continuous current (MCC).

The recommended switching frequency of the drive is 2 to 3 kHz. Higher switching frequencies can result in motor overheating and reduced efficiency.

The normal ratio of the voltage/frequency should be kept constant throughout the 35 to 60 Hertz range. At frequencies higher than 60 Hertz, the voltage/frequency ratio cannot be kept constant because the output voltage of the drive cannot be higher than the drive input voltage. **Figure 9** illustrates the voltage-

frequency curves for nominal 230, 460, and 575 volt power supplies.

The CoreSense™ Communications M1-M2 contacts and other safety/protection controls (i.e. high pressure cut-out switch) should be wired in-series with the compressor contactor coil. The compressor contactor should be wired upstream of the variable frequency drive so the drive and compressor are immediately stopped when a safety/protection control trips.

Autotuning

If an Autotuning drive sequence is to be performed with a compressor that has a Coresense Communication module, the following steps must be taken.

1. De-energize control circuit and module power. Remove the control circuit wires from the module (terminals M1 & M2). Connect a jumper across these "control circuit" wires. This will bypass the "control contact" of the module.

CAUTION! The motor protection system within the compressor is now bypassed. Use only temporarily during autotuning sequence.

2. Run the Autotuning sequence of the drive.
3. Remove jumper and reconnect control circuit wires to the module.

Starting and Ramp Up

The starting frequency should be equal to or greater than 35 Hertz. After starting the compressor at a minimum of 35 Hertz, the frequency should be ramped up to 50 or 60 Hertz within 3 seconds. The compressor should operate at 50/60 Hertz for a minimum of 10 seconds before ramping the speed up or down to the desired operating speed. A normal ramp speed is 200 revolutions per second.

Stopping

Ramping down the frequency to 35 Hertz before stopping the drive-compressor is considered a good shutdown routine. However, given the operating frequency and speed range of the compressor it is not necessary to decelerate the compressor prior to shutdown. Depending on the drive interface and control, the drive should be given a "stop" command to stop the compressor. In rare cases when a system protection device trips (i.e. high pressure cut-out switch) power to the drive input should be immediately interrupted.

Vibration

A compressor driven at a variable speed will impose different frequencies at each speed, so the framework and piping design to accommodate vibration throughout the speed range can be more complex. As a rule of thumb, the system should be designed, or the drive control should be configured (skip frequencies program), such that there is no operation at resonant frequencies between 35 and 75 Hertz.

Oil Recovery Cycle

Particular attention must be given to the system refrigerant pipe size with the variable speed scrolls. ASHRAE guidelines for pipe sizing should be followed to ensure that refrigerant velocities are high enough at low speeds to ensure oil return to the compressor. At the same time, high refrigerant velocities at high speed operation can result in excessive pressure drop and loss of system efficiency. A careful evaluation and compromise in pipe sizing will likely have to be settled upon. A compressor sample with a sight-tube for monitoring the oil level should be used during system development to ensure an adequate oil level is maintained during all operating conditions and speeds.

If testing shows a gradual, continuous loss of oil in the compressor sight-tube over long run cycles at low speed, an oil recovery cycle should be incorporated into the system logic. A recovery cycle is accomplished by ramping the compressor up to a higher speed to increase the refrigerant flow rate to flush or sweep oil back to the compressor. How often a recovery cycle is initiated depends on many variables and would have to be determined through testing for each system type and configuration. A default method could be to initiate a recovery cycle at regular intervals.

Variable Speed Manifolder Applications

The most favorable oil balancing occurs when a VFD is applied to both compressors in the tandem set and the two-phase tandem line (TPTL) is used. See the following section on **Manifolder Compressors** for a complete description of manifolder compressors and oil balancing. If only one VFD is applied to one compressor in a tandem set, the VFD should be applied to the compressor in the "A" position (see **Figure 7**). Trio manifolder compressor configurations have not been tested and qualified for variable speed operation.

APPLICATION TESTS

Application Test Summary

There are a minimal number of tests the system designer will want to run to ensure the system operates as designed. These tests should be performed during system development and are dependent on the system type and amount of refrigerant charge. These application tests are to help identify gross errors in system design that may produce conditions that could lead to compressor failure.

For manifolder compressor assemblies, oil balancing tests must be performed to demonstrate oil balancing between the compressors. Compressors with sight-tubes for viewing a wide range of oil levels is appropriate for this type of testing. The least amount of testing will evaluate the minimum and maximum flow conditions at which the compressors will be required to operate, with min and max suction superheat.

For variable speed applications, the above oil balancing and system oil return tests must be performed. The concern is a very low oil level after extended hours of operation at low speed (40 Hertz). In addition to oil balancing and system oil return tests, the suction and discharge tubing must be evaluated to determine the resonant frequencies. Once the resonant frequencies are known, they can be shifted to a safe range by changing the mass of the line for constant speed applications or they can be avoided for variable speed applications.

As always, Application Engineering is available to recommend additional tests and to evaluate test results.

ASSEMBLY LINE PROCEDURES

Compressor Handling



Use care and the appropriate material handling equipment when lifting and moving compressors. Personal safety equipment must be used.

The suction and discharge plugs should be left in place until the compressor is set into the unit. If possible, the compressor should be kept vertical during handling. The discharge connection plug should be removed first before pulling the suction connection plug to allow the dry air pressure inside the compressor to escape. Pulling the plugs in this sequence prevents oil mist from coating the suction tube making brazing difficult.

The copper coated steel suction tube should be cleaned before brazing (see Figure 3). No object (e.g. a swaging tool) should be inserted deeper than two inches (51 mm) into the suction tube, or it might damage the suction screen and motor.

Mounting

The tested rubber mounting grommet and sleeve kit is listed in Table 4.

Many OEM customers buy the mounting parts directly from the supplier, but Emerson's grommet design and durometer recommendations should be followed for best vibration reduction through the mounting feet. Please see AE4-1111 for grommet mounting suggestions and supplier addresses.

Suction and Discharge Fittings

These compressors are available with stub tube or rotalock connections. The stub tube version has copper-plated steel suction and discharge fittings. Due to the different thermal properties of steel and copper, brazing procedures may have to be changed from those commonly used. See Figure 3 for assembly line and field brazing procedures and Table 2 for Rotalock torque values.

Assembly Line Brazing Procedure

WARNING

Personal safety equipment must be used during brazing operation. Heat shields should be used to prevent overheating or burning nearby temperature sensitive parts. Fire extinguishing equipment should be accessible in the event of a fire.

Figure 3 discusses the proper procedures for brazing the suction and discharge lines to a scroll compressor. **NOTICE: It is important to flow nitrogen through the system while brazing all joints during the system assembly process.** Nitrogen displaces the air and prevents the formation of copper oxides in the system. If allowed to form, the copper oxide flakes can later be swept through the system and block screens such as those protecting capillary tubes, thermal expansion valves, and accumulator oil return holes. The blockage – whether it is of oil or refrigerant – is capable of doing damage resulting in compressor failure.

Unbrazing System Components

WARNING

Before attempting to braze, it is important to recover all refrigerant from both the high and low side of the system.

If the refrigerant charge is removed from a scroll-equipped unit by evacuating the high side only, it is possible for the scrolls to seal, preventing pressure equalization through the compressor. This may leave the low side shell and suction line tubing pressurized. If a brazing torch is then applied to the low side while the low side shell and suction line contain pressure, the pressurized refrigerant and oil mixture could ignite when it escapes and contacts the brazing flame. **CAUTION! It is important to check both the high pressure and low pressure sides with manifold gauges before unbrazing.** Instructions should be provided in appropriate product literature and assembly (line repair) areas. If compressor removal is required, the compressor should be cut out of system rather than unbrazed. See Figure 3 for the proper compressor removal procedure.

Pressure Testing

WARNING

Never pressurize the compressor to more than 400 psig (27.6 bar) for ZR*KCE and 475 psig (32.8 bar) for ZP*KCE compressors. Never pressurize the compressor from a nitrogen cylinder or other pressure source without an appropriately sized pressure regulating and relief valve.

Higher pressure may result in permanent deformation of the compressor shell and possibly cause misalignment or bottom cover distortion.

Assembly Line System Charging Procedure

Systems should be charged with liquid on the high side to the extent possible. The majority of the charge should be pumped in the high side of the system to prevent low voltage starting difficulties, hipot failures, and bearing washout during the first-time start on the assembly line. If additional charge is needed, it should be added as **liquid** to the low side of the system with the compressor operating. Pre-charging on the high side and adding liquid on the low side of the system are both meant to protect the compressor from operating with abnormally low suction pressures during charging. **NOTICE: Do**

not operate the compressor without enough system charge to maintain at least 55 psig (3.8 bar) suction pressure for R-410A and 20 psig (1.4 bar) for R-22 & R-407C. Do not operate the compressor with the low pressure cut-out disabled. Do not operate with a restricted suction or liquid line. Do not use the compressor to test the opening set point of a high pressure cutout. Bearings are susceptible to damage before they have had several hours of normal running for proper break in.

Electrical Connections

The orientation of the electrical connections on the Copeland Scroll™ compressors is shown in **Figure 5**. The T-block screw terminals used on this compressor should be fastened with a torque of 21 to 25 in-lb (2.37 to 2.82 Nm). See **Table 2**.

Every effort should be made to keep the terminal box completely sealed. Oversized conduits, poor conduit connections to the terminal box, an incorrectly installed terminal box cover or a missing terminal box cover gasket are a few possible air leakage paths. **CAUTION! Moisture from warm, moist air that is permitted to freely enter the terminal box can condense into droplets of water inside the cooler terminal box of the compressor. To alleviate this problem, the warm, moist air must be prevented from entering the terminal box. Sealing conduits and eliminating other air leakage paths must be taken. Dow Corning 3165 RTV is ideally suited for sealing around wires in a conduit at the compressor terminal box. Drilling a hole in the bottom of the terminal box to allow the moisture to escape is not acceptable.**

“Hipot” (AC High Potential) Testing



Use caution with high voltage and never hipot when compressor is in a vacuum.

Copeland Scroll compressors are configured with the motor down and the pumping components at the top of the shell. As a result, the motor can be immersed in refrigerant to a greater extent than hermetic reciprocating compressors when liquid refrigerant is present in the shell. In this respect, the scroll is more like semi-hermetic compressors which can have horizontal motors partially submerged in oil and refrigerant. When Copeland Scroll compressors are hipot tested with liquid refrigerant in the shell, they can show higher levels of leakage current than compressors with the motor on top.

This phenomenon can occur with any compressor when the motor is immersed in refrigerant. The level of current leakage does not present any safety issue. To lower the current leakage reading, the system should be operated for a brief period of time to redistribute the refrigerant to a more normal configuration and the system hipot tested again. See **AE4-1294** for Megohm testing recommendations. **Under no circumstances should the hipot test be performed while the compressor is under a vacuum.**

Tandem Assembly

The following procedure outlines the basic steps to assemble a tandem.

1. Mount both compressors to the rails using the appropriate hardware. Mounting bolts should be snug, but not tight, so some movement of the compressor is possible for aligning the manifolds.
2. Install the suction and discharge manifolds. If the manifolds are brazed to the compressors following the brazing guide in **Figure 3**. If the manifolds are connected to the compressors with rotalocks torque the rotalocks to the value specified in **Table 2**.
3. Tilt the tandem assembly back approximately 12 degrees from horizontal so the oil flows away from the oil fittings and sight-glasses on the compressors. This can be accomplished by placing 4x4 wood blocks under the tandem rail closest to the oil fittings on the compressors. Install the oil manifold (TPTL or OEL) to the individual compressors and torque the rotalock fittings to the value specified in **Table 2**.
4. Torque the compressor to rail mounting bolts to the value specified in **Table 2**.

For a detailed instruction list of how to assemble a trio of compressors, please contact Application Engineering.

SERVICE PROCEDURES

CAUTION

POE oil must be handled carefully and the proper protective equipment (gloves, eye protection, etc.) must be used when handling POE lubricant. POE must not come into contact with any surface or material that might be harmed by POE, including without limitation, certain polymers (e.g. PVC/CPVC and polycarbonate).

Field Replacement

WARNING

Use care and the appropriate material handling equipment when lifting and moving compressors. Personal safety equipment must be used.

Mounting

Soft or semi-hard mounting grommets, if used, should be replaced when the compressor is replaced. Grommet hardness can change over time when exposed to various ambient conditions. Rigid mounting hardware can probably be reused with the replacement compressor and should be evaluated by the service technician.

Removing Oil

If the oil level is higher than the oil Schrader fitting on the sump of the compressor oil can be drained from this fitting until the oil level reaches the level of the Schrader fitting. To remove oil from the compressor when the oil level is below the oil Schrader fitting one of two different procedures can be used. The first procedure is to remove the compressor from the system and drain the oil from the compressor suction connection. This method ensures complete removal of the oil from the compressor. The second procedure is to remove the compressor sight-glass and insert a hose into the sump of the compressor and draw the oil out with a hand-held pump (Yellow Jacket Pump UPC#77930).

Electrical

When replacing a compressor, especially one that has been in the field for a number of years, it is always a good idea to replace the contactor.

Note: See the locked rotor on the nameplate of the new compressor and make sure the contactor exceeds this locked rotor rating.

Module

If the replacement compressor is the same as the model being replaced (i.e. ZP235KCE-TWD is being replaced by ZP235KCE-TWD) the motor protection scheme will be the same and won't require any special configuration during the change-out. If the replacement compressor is equipped with CoreSense and the failed compressor has a Kriwan module, the CoreSense module must be configured to operate in standalone mode. Please refer to **AE8-1384** for information on CoreSense module configuration.

Compressor Replacement after Motor Burn

In the case of a motor burn, the majority of contaminated oil will be removed with the compressor. The rest of the oil is cleaned through use of suction and liquid line filter dryers. A 100% activated alumina suction filter drier is recommended but must be removed after 72 hours. See **AE24-1105** for clean up procedures and **AE11-1297** for liquid line filter-drier recommendations.

NOTICE: It is highly recommended that the suction accumulator be replaced if the system contains one. This is because the accumulator oil return orifice or screen may be plugged with debris or may become plugged shortly after a compressor failure. This will result in starvation of oil to the replacement compressor and a second failure.

Manifolded Compressor Replacement

WARNING

When lifting manifolded compressor assemblies, all compressors must be lifted by their respective lifting rings. Use care and exercise extreme caution when lifting and moving compressors. Personal safety equipment must be used.

In the event that a compressor should fail in a manifolded set, only the failed compressor should be replaced. The oil from the failed compressor will stay mostly in the failed compressor. Any contaminated oil that does enter the other compressor sumps will be cleaned by the liquid line filter drier, and when used, the suction line filter drier.

Changing a compressor in a manifolded set that uses rotalock connected manifolds simplifies the change-out process. After the refrigerant is recovered, and it is verified through the use of gauges that no residual refrigerant pressure is in the section of the system being serviced, the suction and discharge rotalock fittings can be disconnected from the failed compressor. Always use new rotalock o-ring seals when connecting the replacement compressor (see **Table 4** for part numbers). If the suction and discharge manifolds are brazed to the compressor, carefully cutting the piping connections close the compressor stubs usually allows connection of the replacement compressor with couplings and short lengths of copper piping. **Do not attempt to unbrazed the piping from the failed compressor.**

Care must be used when removing the oil line connecting the compressor sumps. Catch pans should be placed under the compressor oil fittings to catch oil that may flow out of the compressors when the oil line is removed. It is highly recommended to place plastic (polyethylene plastic that is available at any hardware store) under the compressors to catch any spilled oil. Always use new rotalock o-ring seals when connecting the oil line to the replacement compressor (see **Table 4** for part numbers).

Start-up of a New or Replacement Compressor

It is good service practice, when charging a system with a scroll compressor, to charge liquid refrigerant into the high side only. It is not good practice to dump liquid refrigerant from a refrigerant cylinder into the crankcase of a stationary compressor. If additional charge is required, charge liquid into the low side of the system with the compressor operating. **WARNING! Do not start the compressor while the system is in a deep vacuum.** Internal arcing may occur when any type of compressor is started in a vacuum. **NOTICE: Do not operate the compressor without enough system charge to maintain at least 55 psig (3.8 bar) suction pressure for R-410A and 20 psig (1.4 bar) for R-22 & R-407C. Do not operate with a restricted suction or liquid line. Do not operate with the low pressure cut-out disabled.** Never install a system in the field and leave it unattended with no charge, a holding charge, or with the service valves closed without securely locking out the system. This will prevent unauthorized personnel from accidentally ruining the compressor by operating with no refrigerant flow.

As mentioned in the **Manifolded Applications** section, attention must be given to compressor oil levels when commissioning a new system and servicing an existing system. Oil levels should be checked with the compressor "off" and after the oil has had a chance to equalize between the compressors (for manifolded applications). If oil can't be seen in the sight-glass of the compressor, add oil until the sight-glass is approximately half full.

Field Troubleshooting the Kriwan Module

Follow the steps listed below to troubleshoot the module in the field. See the wiring diagram in **Figure 5** or in the terminal box cover.

1. De-energize control circuit and module power. Remove the control circuit wires from the module (Terminals M1 & M2). Connect a jumper across these "control circuit" wires. This will bypass the "control contact" of the module.

CAUTION! The motor protection system within the compressor is now bypassed. Use this configuration to temporarily test module only.

Re-energize the control circuit and module power.

If the compressor will not operate with the jumper installed, then the problem is external to the solid state protection system.

If the compressor operates with the module bypassed but will not operate when the module is reconnected, then the control circuit relay in the module is open. The thermistor protection chain now needs to be tested to determine if the module's control circuit relay is open due to excessive internal temperatures or a faulty component.

2. Check the thermistor protection chain located in the compressor as follows:

De-energize control circuit and module power. Remove the sensor leads from the module (S1 & S2). Measure the resistance of the thermistor protection chain through these sensor leads with an ohmmeter.

NOTICE: Use an Ohmmeter with a maximum of 9 volts to check the sensor chain. The sensor chain is sensitive and easily damaged; no attempt should be made to check continuity through it with anything other than an ohmmeter. The application of any external voltage to the sensor chain may cause damage requiring the replacement of the compressor.

The diagnosis of this resistance reading is as follows:

- 200 to 2250 ohms – Normal operating range
- 2750 ohms or greater – Compressor overheated – Allow time to cool
- zero resistance – Shorted sensor circuit – Replace the compressor

- infinite resistance – Open sensor circuit – Replace the compressor

If the resistance reading is abnormal, remove the sensor connector plug from the compressor and measure the resistance at the sensor fusite pins. This will determine if the abnormal reading was due to a faulty connector

On initial start-up, and after any module trip, the resistance of the sensor chain must be below the module reset point before the module circuit will close. The reset value is less than 2750 ohms.

3. If the sensor chain has a resistance that is below 2250 ohms, and the compressor will run with the control circuit bypassed, but will not run when connected properly, the solid state module is defective and should be replaced. The replacement module must have the same supply voltage rating as the original module.

Field Troubleshooting CoreSense Communications Module

A solid green LED indicates the module is powered and operation is normal. A solid red LED indicates an internal problem with the module. If a solid red LED is encountered, power down the module (interrupt the T1-T2 power) for 30 seconds to reboot the module. If a solid red LED is persistent, change the CoreSense module.

CoreSense communicates **Warning** codes via a green flashing LED. **Warning** codes do not result in a trip or lockout condition. **Alert** codes are communicated via a red flashing LED. **Alert** codes will result in a trip condition and possibly a lockout condition.

Separate motor and scroll thermistor circuits are used with CoreSense (See the wiring diagram in **Figure 5**). **Table 7** lists the trip and reset values for motor and scroll thermistor circuits. With the CoreSense module in stand-alone mode (dip switch 8 turned "off" or down), similar troubleshooting procedures that are used with the Kriwan module can be applied to the CoreSense module.

Table 8 lists the flash code information for **Warning** and **Alert** codes along with code reset and troubleshooting information. For more information on CoreSense please refer to **AE8-1384**.

Copeland Scroll Compressor Functional Check

A functional compressor test with the suction service valve closed to check how low the compressor will pull suction pressure is **not** a good indication of how well a compressor is performing. **Such a test may damage a scroll compressor.** The following diagnostic procedure should be used to evaluate whether a Copeland Scroll compressor is working properly.

1. Proper voltage to the unit should be verified.
2. The normal checks of motor winding continuity and short to ground should be made to determine if the inherent overload motor protector has opened or if an internal motor short or ground fault has developed. If the protector has opened, the compressor must be allowed to cool sufficiently to allow it to reset.
3. Proper indoor and outdoor blower/fan operation should be verified.
4. With service gauges connected to suction and discharge pressure fittings, turn on the compressor. If suction pressure falls below normal levels, the system is either low on charge or there is a flow blockage in the system.
5. If suction pressure does not drop and discharge pressure does not rise to normal levels, reverse any two of the compressor power leads and reapply power to make sure compressor was not wired to run in reverse direction. If pressures still do not move to normal values, either the reversing valve (if so equipped) or the compressor is faulty. Reconnect the compressor leads as originally configured and use normal diagnostic procedures to check operation of the reversing valve.
6. To test if the compressor is pumping properly, the compressor current draw must be compared to published compressor performance curves using the operating pressures and voltage of the system. If the measured average current deviates more than $\pm 15\%$ from published values, a faulty compressor may be indicated. A current imbalance exceeding 15% of the average on the three phases should be investigated further. A more comprehensive trouble-shooting sequence for compressors and systems can be found in Section H of the **Emerson Electrical Handbook, Form No. 6400**.

7. Before replacing or returning a compressor: Be certain that the compressor is actually inoperable. As a minimum, recheck a compressor returned from the field in the shop or depot for Hipot, winding resistance, and ability to start before returning. More than one third of compressors returned to Emerson Climate Technologies, Inc. for warranty analysis are determined to have nothing found wrong. They were misdiagnosed in the field as being inoperable. Replacing working compressors unnecessarily costs everyone.

Refrigerant Retrofits

NOTICE

ZR compressors are UL recognized for use with R-22, R-407C, or R-134a only. Use of any other refrigerants will void the compressor UL recognition.

Only those systems that are in need of service should be considered for a refrigerant retrofit if R-22 is not available. Systems that are operating without issue should be maintained and not be considered for a refrigerant retrofit. In most if not all cases, the retrofitted system will not be as energy efficient as the R-22 system.

Only those refrigerants approved by Emerson Climate Technologies, Inc. and the OEM should be considered. For a list of Emerson approved refrigerants please refer to Form **93-11, *Refrigerants and Lubricants Approved for Use in Copeland Compressors***. Please consult with the OEM to obtain their input and approval on refrigerant retrofitting.

If the compressor lubricant is mineral oil, it must be changed to POE for a successful retrofit. See the section **Removing Oil** for instructions on how to remove the oil charge from the compressor.

POE oil should be added to the compressor through the oil charging connection on the sump of the compressor. The compressor should be filled to 1/2 sight-glass.

For detailed R-407C retrofit instructions please refer to Form **95-14, *Refrigerant Changeover Guidelines for R-22 to R-407C***. For other retrofit guidelines please refer to the equipment OEM.

20 to 40 Ton Scroll Nomenclature

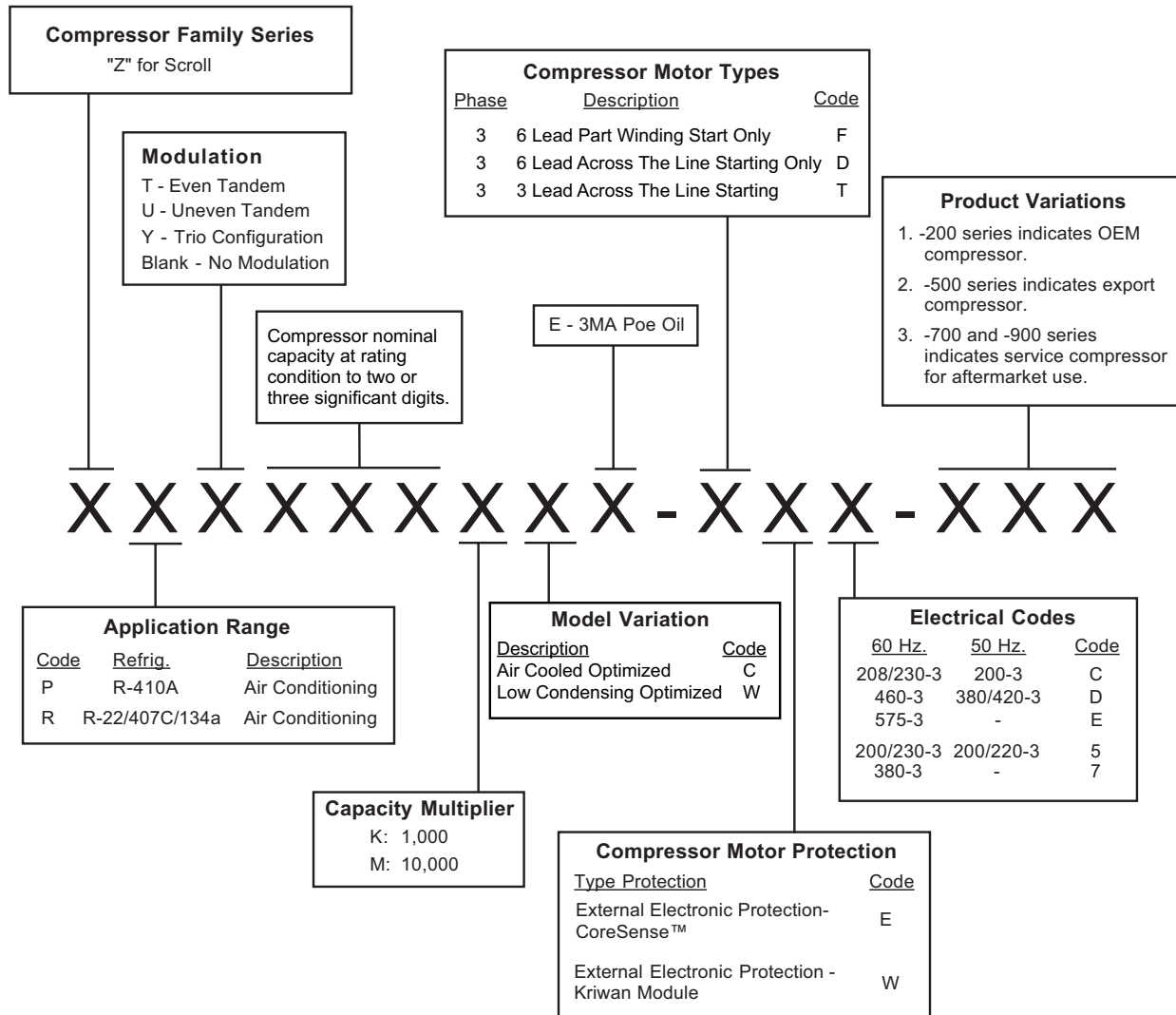

Figure 1 – Nomenclature

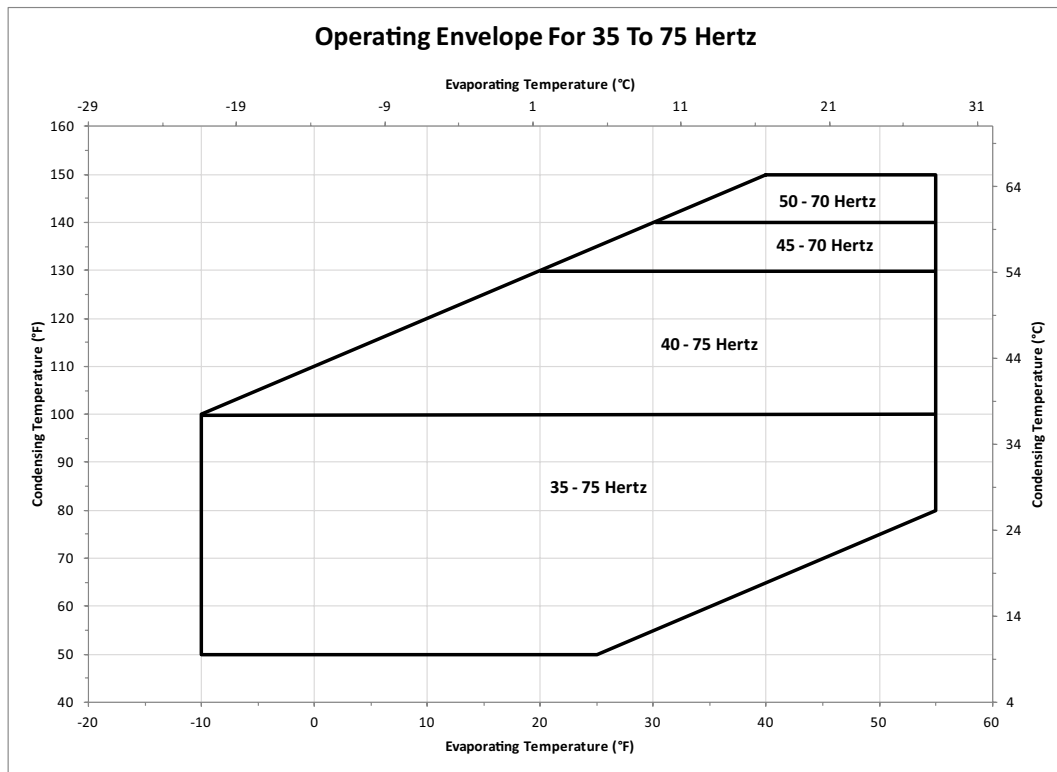
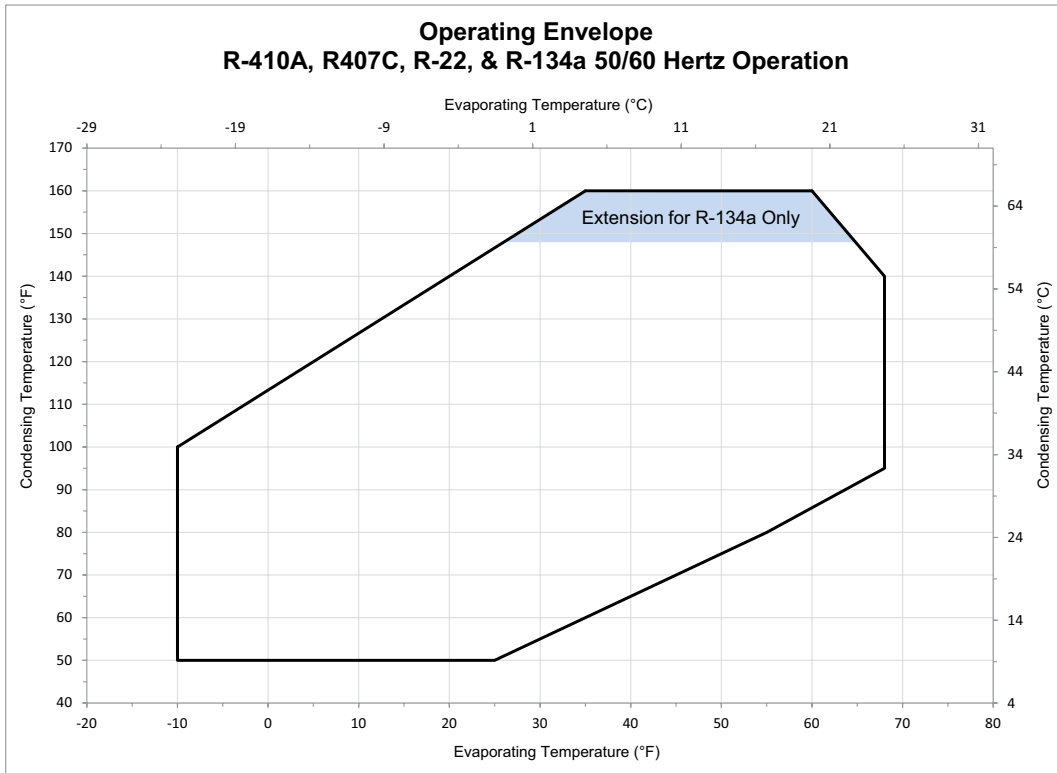

Figure 2 – 20 to 40 Ton Scroll Operating Envelopes

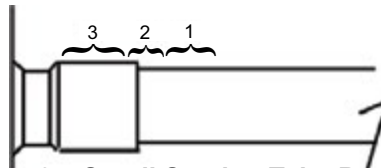

Figure 3 – Scroll Suction Tube Brazing

New Installations

- The copper-coated steel suction tube on scroll compressors can be brazed in approximately the same manner as any copper tube.
- Recommended brazing materials: Any silfos material is recommended, preferably with a minimum of 5% silver. However, 0% silver is acceptable.
- Be sure suction tube fitting I.D. and suction tube O.D. are clean prior to assembly. If oil film is present wipe with denatured alcohol, Dichloro-Trifluoroethane or other suitable solvent.
- Using a double-tipped torch apply heat in Area 1. As tube approaches brazing temperature, move torch flame to Area 2.
- Heat Area 2 until braze temperature is attained, moving torch up and down and rotating around tube as necessary to heat tube evenly. Add braze material to the joint while moving torch around joint to flow braze material around circumference.
- After braze material flows around joint, move torch to heat Area 3. This will draw the braze material down into the joint. The time spent heating Area 3 should be minimal.
- As with any brazed joint, overheating may be detrimental to the final result.

Field Service



Remove refrigerant charge from both the low and high side of the compressor before cutting the suction and discharge lines to remove the compressor. Verify the charge has been completely removed with manifold gauges.

- To disconnect: Reclaim refrigerant from both the high and low side of the system. Cut tubing near compressor.
- To reconnect:
 - Recommended brazing materials: Silfos with minimum 5% silver or silver braze material with flux.
 - Insert tubing stubs into fitting and connect to the system with tubing connectors.
 - Follow **New Installation** brazing

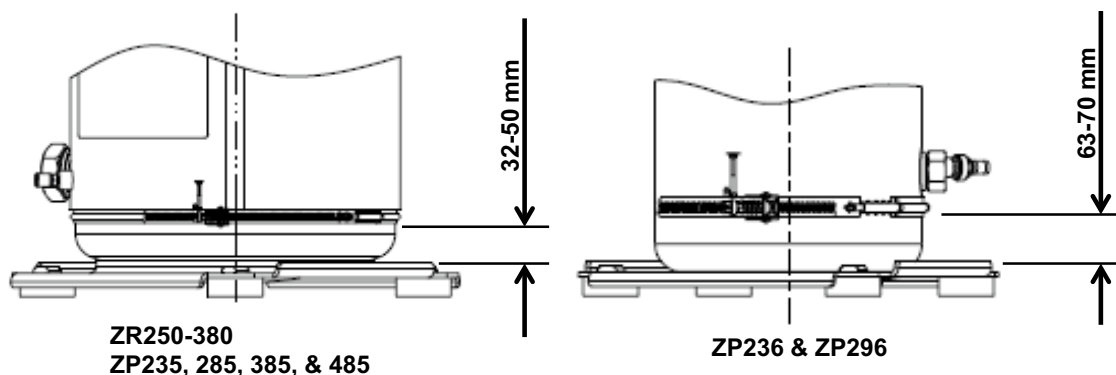

Figure 4 – Crankcase Heater Location

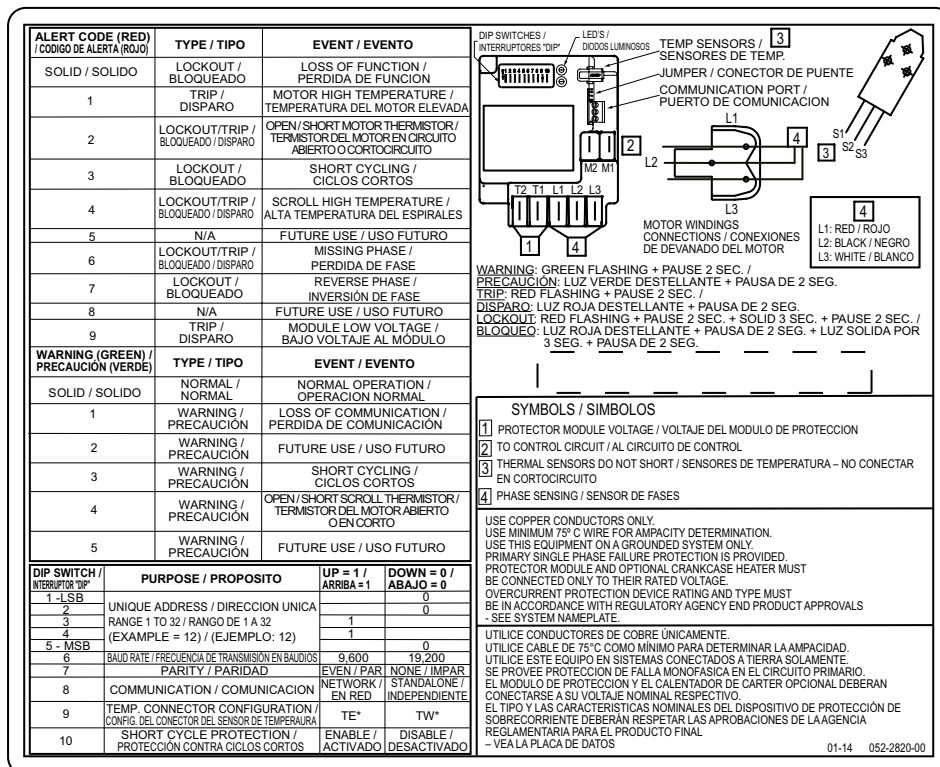

Figure 5a – 20 to 40 Ton Terminal Box Wiring Diagram (excluding ZP236/296)

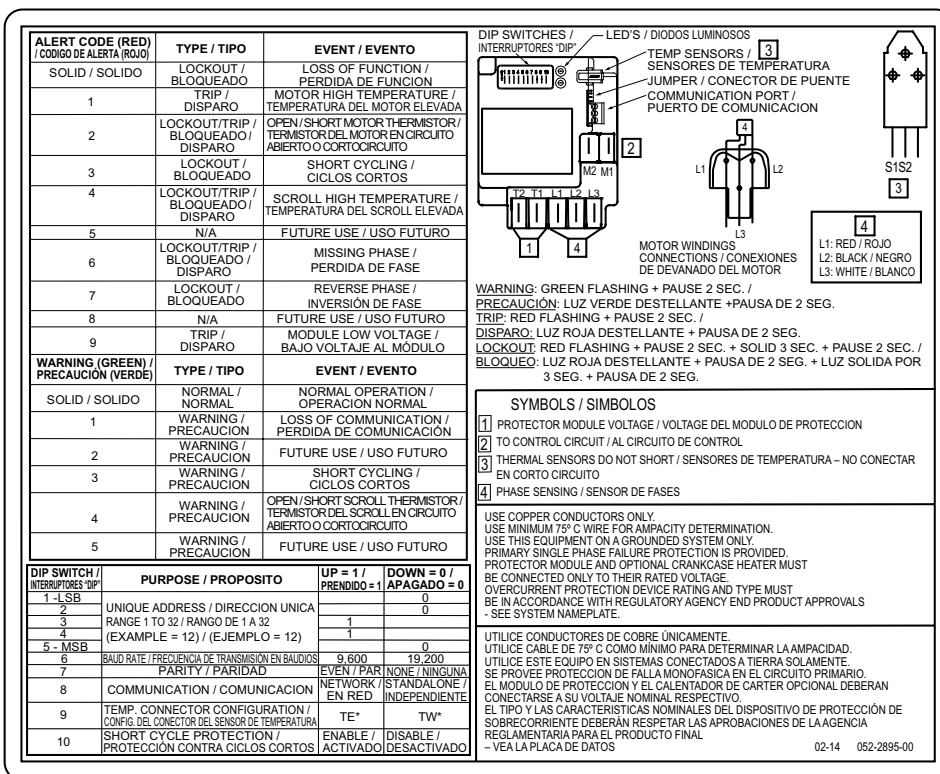

Figure 5b – ZP236/296 Terminal Box Wiring Diagram

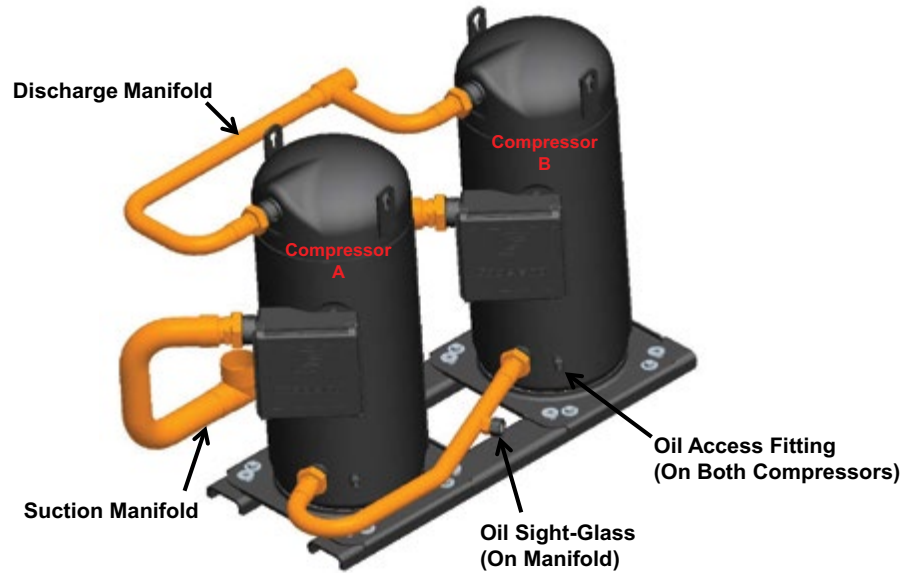

Figure 6 – Typical Rotalock Connected Tandem with TPTL Oil Manifold

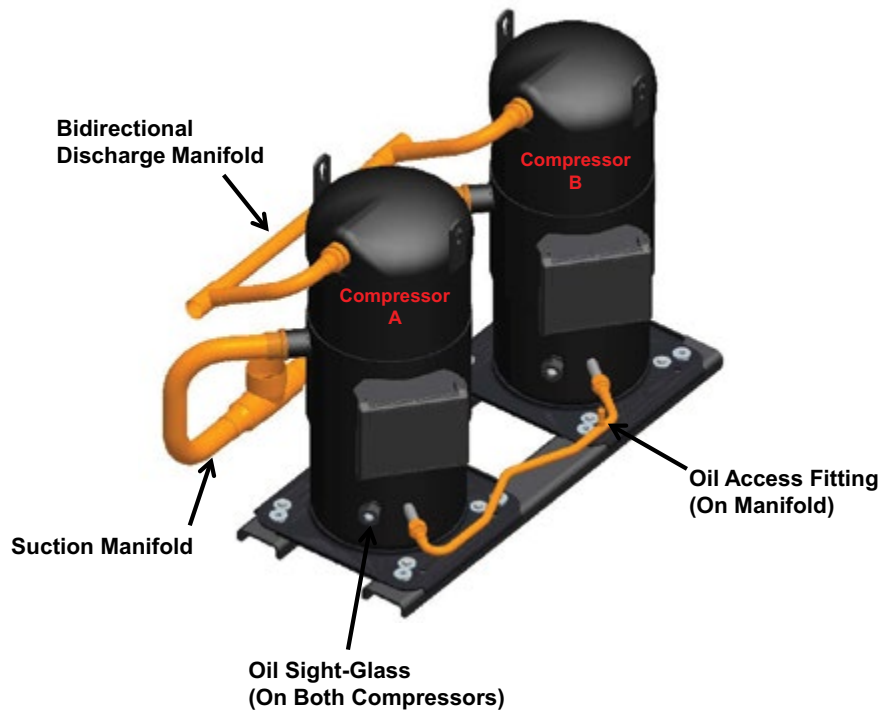

Figure 7 – Typical Braze Connected Tandem with OEL Oil Manifold



Figure 8 – Typical Braze Connected Trio with TPTL Oil Manifold

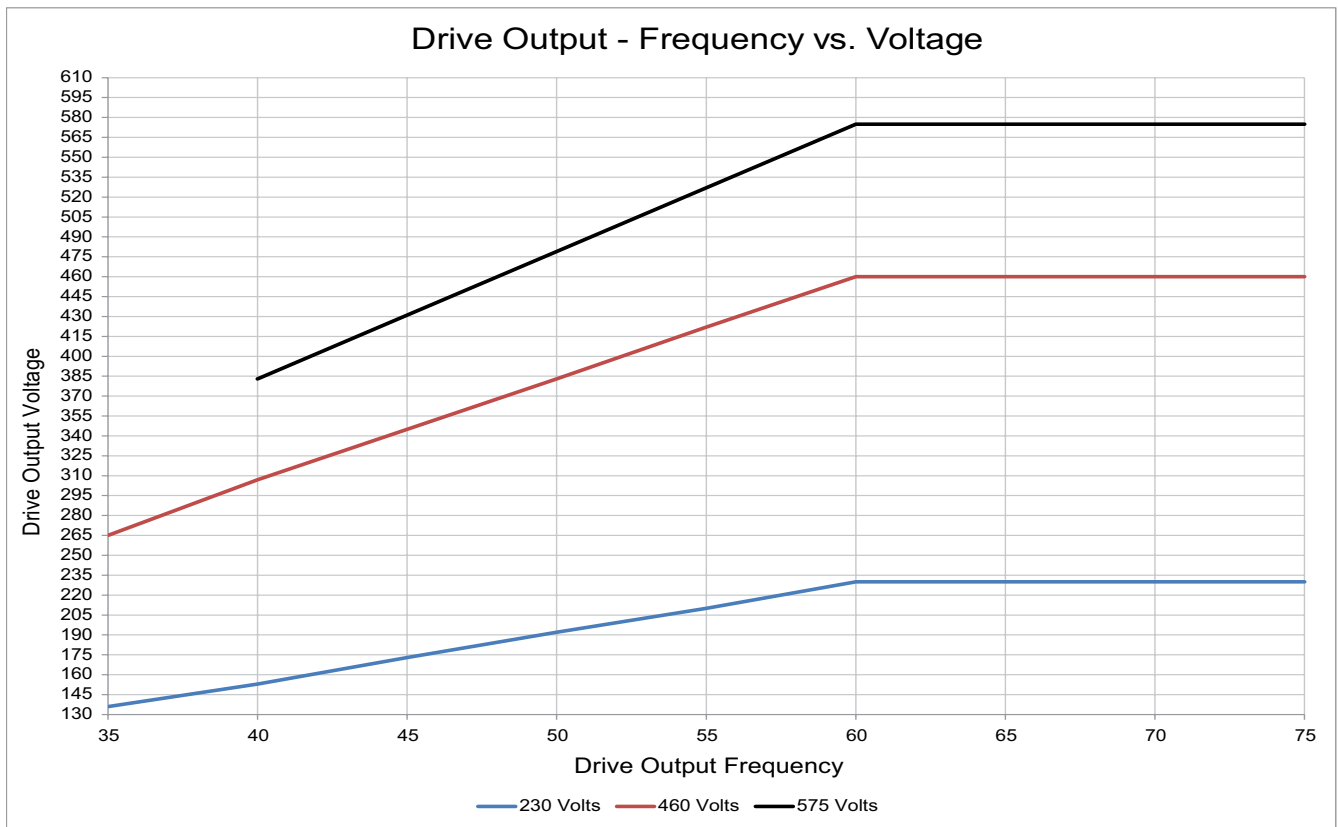

Figure 9 – Drive Output - Frequency vs. Voltage

**Table 2
Torque Values**

Part	Torque		
	ft-lb	in-lb	N-m
Sight-Glass	50-58	600-690	68-78
TPTL Rotalock Fitting	125-133	1500-1590	170-180
OEL Rotalock Fitting	50-58	600-690	68-78
Suction Rotalock (Valve or Adapter)	140-148	1680-1770	190-200
Discharge Rotalock (Valve or Adapter)	125-133	1500-1590	170-180
Schrader Valves	17-18	200-220	22.6-24.0
Oil Access Fitting (Threads Into Oil Rotalock)		40-60	4.5-6.8
Terminal Block Screws		25	2.8
Tandem Mounting Bolts (M10)	33-41	398-487	45-55

**Table 3
Refrigerant Charge Limits**

Model	Charge Limit	
	Pounds	kg
ZR250KC	25	11.3
ZR300-380KC	30	13.6
ZR Tandems	45	20.4
ZR Trios	65	29.5
ZP235, 236, 296KC	25	11.3
ZP285, 295, 385, 485KC	30	13.6
ZP Tandems	45	20.4
ZP Trios	65	29.5

Table 4 – Compressor Accessories

Part Category	Part Description	ZR250 ZP235	ZP236 ZP296	ZR300 ZP285	ZR310 ZR380 ZP295 ZP385	ZP485
Mounting	Spacer-Mounting Kit	527-0175-02	527-0175-02	527-0175-00	527-0175-02	527-0175-02
Crankcase Heater	Crankcase Heater, 120V	018-0091-06	018-0091-27	018-0091-10	018-0091-10	018-0091-10
	Crankcase Heater, 240V	018-0091-04	018-0091-25	018-0091-09	018-0091-09	018-0091-09
	Crankcase Heater, 480V	018-0091-05	018-0091-26	018-0091-08	018-0091-08	018-0091-08
	Crankcase Heater, 575V	018-0091-07	018-0091-28	018-0091-11	018-0091-11	018-0091-11
	Crankcase Heater Junction Box	962-0001-03	962-0001-03	962-0001-03	962-0001-03	962-0001-03
Oil	Oil Sight-Glass	970-0021-00	070-0040-00	970-0021-00	970-0021-00	970-0021-00
	Oil Access Fitting	510-0370-00	510-0715-00	510-0370-00	510-0370-00	510-0715-00
Electrical	Terminal Box Assembly ¹					
	Terminal Block	021-0332-00	021-0332-00	021-0332-00	021-0332-00	021-0332-00
	Terminal Block Screws (Zinc Plated 10-32 UNF-2A x .5" Long) ²	100-0550-01	100-0550-01	100-0550-01	100-0550-01	100-0550-01
Protection	Kriwan Module 120/240V	998-0520-00		998-0520-00	998-0520-00	998-0520-00
	Kriwan Module 24 V	998-0520-04		998-0520-04	998-0520-04	998-0520-04
	CoreSense Module ³ 120/240V	971-0064-05	971-0064-05	971-0064-05	971-0064-05	971-0064-05
	CoreSense Module ³ 24V	971-0065-04	971-0065-04	971-0065-04	971-0065-04	971-0065-04
Suction & Discharge	Suct & Disch 1/4" Schrader Fittings	510-0370-00	510-0370-00	510-0370-00	510-0370-00	510-0370-00
	Discharge Rotalock O-Ring Seal	020-0028-03	020-0028-05	020-0028-03	020-0028-05	020-0028-03
	Suction Rotalock O-Ring Seal	020-0941-00	020-0941-00	020-0941-00	020-0941-00	020-0941-00
	Rotalock Service Valve, Disc 1-3/8"	998-0510-46	998-0510-46	998-0510-46	998-0510-46	998-0510-46
	Rotalock Service Valve, Suct 1-5/8"	998-0510-68	998-0510-68	998-0510-68	998-0510-68	998-0510-68
	Flange Service Valve, Suct 2-1/8"			998-0511-01		
	Disc Rotalock Adapter to 1-3/8" Sweat	934-0002-00	934-0002-00	934-0002-00	934-0002-00	934-0002-00
	Suct Rotalock Adapter to 1-5/8" Sweat	934-0002-01	934-0002-01	934-0002-01	934-0002-01	934-0002-01

¹ Terminal boxes are rarely replaced; please contact Application Engineering if replacement part numbers are required

² Can be purchased locally

³ -TE* motor codes only

Table 5 – Tandem Quick Reference Guide

Tandem Model	Compressor		Drawing #	Compressor Connections			Discharge Manifold	Oil Line		Flow Washers ³		Piping Restrictions
	"A"	"B"		Rota-lock	Brazed	Flanged		OEL	TPTL	Comp. "A"	Comp. "B"	
ZPU417KC	ZP182	ZP235	497-0685-00		X		one direction		X			A minimum of 18" of straight piping upstream of the suction "T" is required
ZPU418KC	ZP182	ZP236	497-1298-00		X		one direction		X			
ZPU449KC	ZP154	ZP295	497-0577-00		X		one direction		X	X		
ZPT470KC	ZP235	ZP235	497-2830-00	X			one direction		X			
ZPT472KC	ZP236	ZP236	497-1184-00		X		bi-directional	X				
	ZP236	ZP236	497-1185-00	X			bi-directional	X				
ZPU477KC	ZP182	ZP295	497-0682-00		X		one direction		X	X		
ZPU532KC	ZP296	ZP236	497-1189-00		X		bi-directional	X			X	
	ZP296	ZP236	497-1190-00	X			bi-directional	X			X	
ZPU567KC	ZP182	ZP385	497-0577-00		X		one direction		X	X		
ZPT570KC	ZP285	ZP285	497-3589-00	X			one direction		X			
ZPT590KC	ZP295	ZP295	497-3589-00	X			one direction		X			
ZPT592KC	ZP296	ZP296	497-1184-00		X		bi-directional	X				
	ZP296	ZP296	497-1185-00	X			bi-directional	X				
ZPU680KC	ZP295	ZP385	497-3585-03	X			one direction		X	X		
ZPU681KC	ZP385	ZP296	497-1316-00		X		bi-directional	X			X	
ZPT770KC	ZP385	ZP385	497-3589-00	X			one direction		X			
	ZP385	ZP385	497-1348-00	X			bi-directional	X				
	ZP385	ZP385	497-1346-00		X		bi-directional	X				
ZPU870KC	ZP385	ZP485	497-0814-00		X		one direction		X	X		
	ZP385	ZP485	497-1484-00	X			bi-directional		X			
ZPT970KC	ZP485	ZP485	497-1122-00		X		bi-directional	X				
	ZP485	ZP485	497-1486-00	X			bi-directional	X				
ZRU441KC	ZR190	ZR250	497-0685-00		X		one direction		X		A minimum of 18" of straight piping upstream of the suction "T" is required	
ZRT500KC	ZR250	ZR250	497-0350-00	X			one direction		X			
ZRU560KC	ZR250	ZR310	497-2825-00	X			one direction		X	X		
ZRU571KC	ZR190	ZR380	497-0577-00		X		one direction		X	X		
ZRT600KC	ZR300	ZR300	497-0348-00	X ¹		X ²	one direction		X			
ZRT620KC	ZR310	ZR310	497-3585-00	X			one direction		X			
ZRU690KC	ZR310	ZR380	497-3585-03	X			one direction		X	X		
ZRT760KC	ZR380	ZR380	497-3589-00	X			one direction		X			

Not in production, drawings only

Notes:

¹ Compressor discharge connections only.

² Compressor suction connections only.

³ Compressor "A" is the compressor on the left, when looking at the assembly from the terminal box side of the compressor.

Table 6 – Trio Quick Reference Guide

Trio Model	Compressor 3X	Drawing #	Compressor Connections			Discharge Manifold	Oil Line	Flow Washers ³			Piping Restrictions	
			Rotalock	Brazed	Flanged			TPTL	Comp. "A"	Comp. "B"		Comp. "C"
ZPY705KC	ZP235KC	497-0391-00	X			unidirectional	X			X	suction flow direction from the "C" compressor direction	
		497-0391-01		X		unidirectional	X			X		
		497-0391-02	X			unidirectional	X	X		X	suction flow direction from the "A" compressor direction	
		497-0391-03		X		unidirectional	X	X		X		
		497-0701-00	X			unidirectional	X					3-5/8" suction connection, 18" of straight suction piping required
		497-0701-01		X		unidirectional	X					
ZPY708KC	ZP236KC	497-1389-00	X			unidirectional	X				3-5/8" suction connection, 18" of straight suction piping required	
		497-1390-00		X		unidirectional	X					
ZPY855KC	ZP285KC	497-0385-04	X			unidirectional	X			X	suction flow direction from the "C" compressor direction	
		497-0385-05		X		unidirectional	X			X		
		497-0385-06	X			unidirectional	X	X		X	suction flow direction from the "A" compressor direction	
		497-0385-07		X		unidirectional	X	X		X		
		497-0385-02	X			unidirectional	X					3-5/8" suction connection, 18" of straight suction piping required
		497-0385-01		X		unidirectional	X					
ZPY885KC & ZPY115MC	ZP295KC & ZP385KC	497-0385-04	X			unidirectional	X			X	suction flow direction from the "C" compressor direction	
		497-0385-05		X		unidirectional	X			X		
		497-0385-06	X			unidirectional	X	X		X	suction flow direction from the "A" compressor direction	
		497-0385-07		X		unidirectional	X	X		X		
		497-0385-02	X			unidirectional	X					3-5/8" suction connection, 18" of straight suction piping required
ZPY888KC	ZP296KC ZP296KC	497-1389-00	X			unidirectional	X				3-5/8" suction connection, 18" of straight suction piping required	
		497-1390-00		X		unidirectional	X					
ZPY145MC	ZP485KC	497-1265-00	X			bidirectional	X				3-5/8" suction connection, 18" of straight suction piping required	
		497-1264-00		X		bidirectional	X					
ZRY750KC	ZR250KC	497-0391-00	X			unidirectional	X			X	suction flow direction from the "C" compressor direction	
		497-0391-01		X		unidirectional	X			X		
		497-0391-02	X			unidirectional	X	X		X	suction flow direction from the "A" compressor direction	
		497-0391-03		X		unidirectional	X	X		X		
		497-0701-00	X			unidirectional	X					3-5/8" suction connection, 18" of straight suction piping required
		497-0701-01		X		unidirectional	X					
ZRY900KC	ZR300KC	497-0385-00	X ¹		X ²	unidirectional	X				3-5/8" suction connection, 18" of straight suction piping required	
		497-0385-01		X		unidirectional	X					
ZRY930KC & ZRY114MC	ZR310KC & ZR380KC	497-0385-04	X			unidirectional	X			X	suction flow direction from the "C" compressor direction	
		497-0385-05		X		unidirectional	X			X		
		497-0385-06	X			unidirectional	X	X		X	suction flow direction from the "A" compressor direction	
		497-0385-07		X		unidirectional	X	X		X		
		497-0385-02	X			unidirectional	X					3-5/8" suction connection, 18" of straight suction piping required
497-0385-03		X		unidirectional	X							

Notes: ¹ Compressor discharge connections only

² Compressor suction connections only

³ Compressor "A" is the compressor on the left, when looking at the assembly from the terminal box side of the compressor. Compressor "B" is the middle compressor and compressor "C" is on the right.

Table 7 – Protector Specifications

Module P/N	071-0649-01	071-0649-00	071-0684-01	071-0684-00	071-0650-00	071-0685-00	571-0065-05	571-0064-06
Compressor Motor Code	TW	TW	TW	TW	TW	TW	TE	TE
Type	Kriwan	Kriwan	Kriwan Diagnose*	Kriwan Diagnose*	Kriwan	Kriwan Diagnose*	CoreSense	CoreSense
T1-T2 Voltage (AC)	24	120/240	24	120/240	115/230	115/230	24	120/240
Power Consumption (VA)	3	3	3	3	3	3	5	5
M1-M2 Contact Rating (A)	2.5	2.5	2.5	2.5	2.5	2.5	2.5	2.5
M1-M2 Minimum Current (A)	> 0.02	> 0.02	> 0.02	> 0.02	> 0.02	> 0.02	N/A	N/A
M1-M2 Maximum Voltage	240	240	240	240	240	240	240	240
Trip Point (Ω)	>4.5KΩ	>4.5KΩ	>4.5KΩ	>4.5KΩ	>4.5KΩ	>4.5KΩ	>4.5KΩ (motor) <2.4KΩ (scroll)	>4.5KΩ (motor) <2.4KΩ (scroll)
Reset Point (Ω)	<2.75KΩ	<2.75KΩ	<2.75KΩ	<2.75KΩ	<2.75KΩ	<2.75KΩ	<2.75KΩ (motor) >5.1KΩ (scroll)	<2.75KΩ (motor) >5.1KΩ (scroll)
Reset Time	30 minutes	30 minutes	30 minutes	30 minutes	30 minutes	30 minutes	30 minutes	30 minutes
Features	Motor & Scroll Temperature Protection				Motor & Scroll Temperature + Phase Protection		Motor & Scroll Temperature, Phase Protection, Communications	

* Diagnose features not supported

Table 8 – CoreSense™ Communications LED Flash Code Information

The flash code number corresponds to the number of LED flashes, followed by a pause, and then the flash code is repeated. A lockout condition produces a red flash, followed by a pause, a solid red, a second pause, and then repeated.

Status	Fault Condition	Code Fault Description	Code Reset Description	Troubleshooting Information
Solid Green	Normal Operation	Module is powered and operation is normal	N/A	N/A
Solid Red	Module Malfunction	Module has internal fault	N/A	1) Reset module by removing power from T2-T1 2) Replace module
Warning LED Flash				
Green Flash Code 1	Loss of Communication	Module and master controller have lost communications with each other for more than 5 minutes	When communications are confirmed	1) Check the control wiring 2) Verify dipswitch 8 is "on"
Green Flash Code 2	Future Use	N/A	N/A	N/A
Green Flash Code 3	Short Cycling	Run time of less than 1 minute; number of short cycles exceeds 48 in 24 hours	< 48 short cycles in 24 hours	1) Check system charge and pressure control setting 2) Adjust set-point of temperature controller 3) Install anti-short cycling control
Green Flash Code 4	Open/Shorted Scroll Thermistor	$\Omega > 370K$ or $\Omega < 1K$	$5.1K < \Omega < 370K$	1) Check for poor connections at module and thermistor fusite 2) Check continuity of thermistor wiring harness
Green Flash Code 5	Future Use	N/A	N/A	N/A
Alert/Lockout LED Flash				
Red Flash Code 1	Motor High Temperature	$\Omega > 4.5K$; Lockout after 5 Alerts	$\Omega < 2.75K$ and 30 minutes	1) Check supply voltage 2) Check system charge & superheat 3) Check contactor
Red Flash Code 2	Open/Shorted Motor Thermistor	$\Omega > 220K$ or $\Omega < 40$; lockout after 6 hours	$40 < \Omega < 2.75K$ and 30 minutes	1) Check for poor connections at module and thermistor fusite 2) Check continuity of thermistor wiring harness
Red Flash Code 3	Short Cycling	Run time of less than 1 minute; lockout if the number of Alerts exceeds the number configured by the user in 24 hours	Interrupt power to T2-T1 or perform Modbus reset command	1) Check system charge and pressure control setting 2) Adjust set-point of temperature controller 3) Install anti-short cycling control

Table 8 Continued

Status	Fault Condition	Code Fault Description	Code Reset Description	Troubleshooting Information
Alert/Lockout LED Flash				
Red Flash Code 4	Scroll High Temperature	$\Omega < 2.4K$; Lockout if the number of Alerts exceeds the number configured by the user in 24 hours	Interrupt power to T2-T1 or perform Modbus reset command	<ol style="list-style-type: none"> 1) Check system charge and superheat 2) Check system operating conditions 3) Check for abnormally low suction pressure
Red Flash Code 5	Future Use	N/A	N/A	N/A
Red Flash Code 6	Missing Phase	Missing phase; Lockout after 10 consecutive Alerts	After 5 minutes and missing phase condition is not present	<ol style="list-style-type: none"> 1) Check incoming power 2) Check fuses/breakers 3) Check contactor
Red Flash Code 7	Reverse Phase	Reverse phase; Lockout after 1 Alert	Interrupt power to T2-T1 or perform Modbus reset command	<ol style="list-style-type: none"> 1) Check incoming phase sequence 2) Check contactor 3) Check module phasing wires A-B-C
Red Flash Code 8	Future Use	N/A	N/A	N/A
Red Flash Code 9	Module Low Voltage	Low voltage on T2-T1 terminals ¹	After 5 minutes and the voltage is back in the normal range	<ol style="list-style-type: none"> 1) Verify correct module p/n 2) Check VA rating of transformer 3) Check for blown fuse in transformer secondary

¹ This Alert does not result in a Lockout

Table 9 – Control Techniques Drive Selections

Model	Compressor Voltage	Frequency	Phase	Drive Name	Drive Model Number	Maximum Continuous Output Current
ZP235KCE-TWC	208/230	60	3	Commander HSK	HSK4203	104
ZP235KCE-TWD	460	60	3	Commander HSK	HSK3402	43
ZP236KCE-TE5	200/230	60	3	Commander HSK	HSK4203	104
ZP236KCE-TED	460	60	3	Commander HSK	HSK3402	43
ZP285KCE-TW5	200/230	60	3	Commander HSK	HSK4203	104
ZP285KCE-TWD	460	60	3	Commander HSK	HSK3403	56
ZP295KCE-TWD	460	60	3	Commander HSK	HSK3403	56
ZP296KCE-TE5	200/230	60	3	Commander HSK	HSK4203	104
ZP296KCE-TED	460	60	3	Commander HSK	HSK3403	56
ZP385KCE-TE5 ZP385KCE-TW5	200/230	60	3	Affinity	BA5201	130
ZP385KCE-TED ZP385KCE-TWD	460	60	3	Commander HSK	HSK4401	68
ZP485KCE-TED ZP485KCE-TWD	460	60	3	Commander HSK	HSK4402	83

The contents of this publication are presented for informational purposes only and they are not to be construed as warranties or guarantees, express or implied, regarding the products or services described herein or their use or applicability. Emerson Climate Technologies, Inc. reserves the right to modify the designs or specifications of such products at any time without notice. Emerson Climate Technologies, Inc. does not assume responsibility for the selection, use or maintenance of any product. Responsibility for proper selection, use and maintenance of any Emerson Climate Technologies, Inc. product remains solely with the purchaser and end-user.