

AE8-1328 R5

March 2011

Copeland® Digital Compressor Controller

Introduction

The Digital Compressor Controller is the electronics interface between the Copeland Scroll Digital™ compressor or the Copeland Discus Digital™ compressor and the system controller. The Digital Compressor Controller is designed only for single phase Copeland Scroll Digital compressors and three phase Copeland Scroll Digital and Discus Digital compressors. (Reference Emerson Climate Technologies **AE21-1319**, **AE4-1357** and **AE21-1355** for details on the digital compressor.) The system controller supplied by the OEM measures temperature, pressure or humidity to calculate the needed compressor capacity and communicates that capacity to the Digital Compressor Controller via an analog signal.

The Digital Compressor Controller provides control, protection and diagnostics for the digital compressor system. The type of compressor and the application determine the version of Digital Compressor Controller that can be used. See **Tables 1, 2 3** and **4** for part number details.

- The Digital Compressor Controller “modulates” or cycles the unloader solenoid in an on/off pattern according to the capacity demand signal from the system controller.
- The compressor contactor coil is controlled based on the capacity demand from the system controller and the presence of any compressor trip or lock out conditions.
- The compressor is protected against high discharge temperature by a discharge temperature thermistor. If the maximum temperature limit is exceeded, the Digital Compressor Controller will protect the compressor by turning it off.
- Seven ALERT codes are displayed indicating an abnormal system or compressor condition. Depending on the severity of the code, the Digital Compressor Controller will shut down the compressor or run the compressor in a limited capacity.
- After each compressor shut down event, in some digital controller module versions a two minute anti-short cycle delay timer is active preventing the compressor from restarting. This is indicated by a flashing green light. See **Table 1** for versions with this feature.

- For systems that need an accurate suction pressure reading, the Digital Compressor Controller is able to smooth out the pressure swings associated with loading and unloading the compressor. A pressure transducer input is “filtered” by using the unloader control algorithm to output a smooth suction pressure signal.
- For systems that include a compressor vapor injection solenoid valve, the compressor controller energizes this valve whenever the compressor is running.

Specifications

Width: 2.0”
(51 mm)



Depth: 6.0” (153 mm)

Operating Temperature: -40°F to 150°F
(-40°C to 65°C)

Storage Temperature: -60°F* to 175°F
(-49°C* to 80°C)

Supply Voltage: 19-28VAC, 48-62Hz

Supply Power: 2 VA maximum

UL Requirements: For power supply:
use only with Class 2
circuits, File #SA32917

Enclosure Protection IP20, NEMA1

*MIL-STD-810F, Method 502.4, 4.5.2

Installation

Four #10 self tapping sheet metal screws, at least ½” length, are required for installation. The maximum mounting screw torque is 20 in.lbs. Locate the Digital Compressor Controller inside the electrical enclosure near the compressor contactor (wire routing for compressor power wiring will be easier in this position). The maximum wire terminal screw torque is 7 in. lbs. The Digital Compressor Controller will operate in any mounting orientation where the green POWER LED is at the top. Mount the Digital Compressor Controller so all LEDs are visible from a comfortable viewing position.

A service panel label (**Form 052-2401-00**) describing the terminals and ALERT flash codes is included with each Digital Compressor Controller. This label should be in a visible location for the technician when he is troubleshooting the system. See **Figure 5**.

Compressor Wiring (See **Figure 3**)

The Digital Compressor Controller senses compressor motor current for diagnostics and protection. The compressor motor leads must be run through the holes in the plastic housing for a current transformer to sense motor current.

Single Phase Compressors: the compressor’s run (R), common (C) and start (S) wires must be routed through the holes in the Digital Compressor Controller module marked “R,” “C” and “S.” The run capacitor may be located on either side of the Digital Compressor Controller module.

Three Phase Compressors: the compressor’s T1, T2 and T3 wires must be routed through the holes in the Digital Compressor Controller module marked “T1,” “T2” and “T3.” The Digital Compressor Controller module is phase insensitive and will not detect reverse phasing of the compressor.

NOTE!

Do not bundle low voltage wires with compressor power or high voltage wires.

NOTE!

Attach cable ties through loops on side of the housing for wire strain relief.

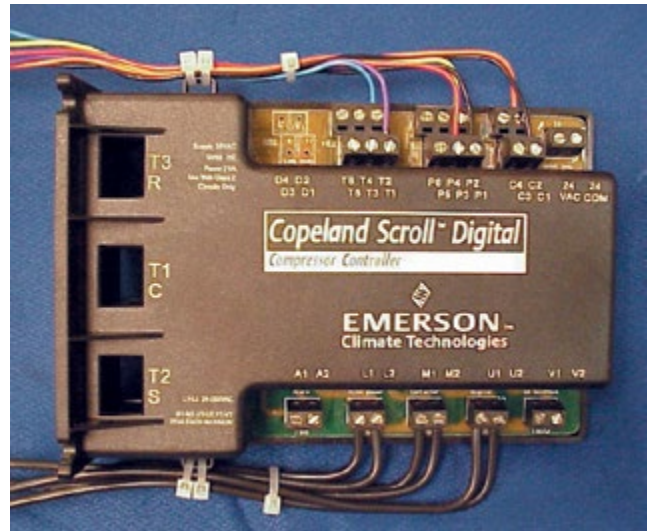

Figure 1

Digital Compressor Controller 543-0024-00, -01



Figure 2

Digital Compressor Controller 543-0086-01

Low Voltage Terminals

24COM	Module Common	
24VAC	Module Power	
C1	Demand Input –	} Recommend } Shielded Cable
C2	Demand Input +	
P1	Pressure Common	
P2	Pressure Input	
P3	Pressure Power 5VDC	
P4	Pressure Shield	
P5	Pressure Output –	
P6	Pressure Output +	
T1	Discharge Temp Sensor	
T2	Discharge Temp Sensor	

High Voltage Terminals

A1	Alarm Relay Out
A2	Alarm Relay Out
M1	Contactors
M2	Contactors
L1	Control Voltage
L2	Control Voltage
U1	Digital Unloader Solenoid
U2	Digital Unloader Solenoid
V1	Vapor Injection Solenoid
V2	Vapor Injection Solenoid

NOTE!

To avoid damaging the Digital Compressor Controller do not connect wires to terminals C3, C4, T3, T4, T5 or T6.

(24VAC, 24COM) Digital Compressor Controller Power

The power supply for the Digital Compressor Controller is 19-28VAC, 48-62Hz. The maximum load is 2 VA. The 24VAC phasing for the Digital Compressor Controller must match the system controller to avoid a transformer short circuit condition because the two controllers have their commons connected together. Twenty-four volt power to the module must be on anytime the unit is on and should not be interrupted by any control. **Center tap transformers are not to be used.**

(C1, C2) System Controller Demand

Controller Demand is an analog input signal from the system controller to the Compressor Controller, proportional to the capacity required from the compressor. Controller Demand is a 1-5VDC input where 1.0VDC is 0% capacity and 5.0VDC is 100% capacity. When the signal falls below 10% capacity (1.25VDC on decreasing demand) the Digital Compressor Controller will shut down the compressor. When the signal rises above 10% capacity (1.44VDC on increasing demand) and the anti-short cycle timer inherent in some controllers (see **Table 1**) has timed out, the Digital Compressor Controller will start the compressor again. See **Figure 4** for a graphical representation. **The maximum input voltage for C1, C2 is 5.3 VDC.**

NOTE!

During normal unit operation the voltage to C2 must be above 0.5 volts. The voltage to C2 should never be completely interrupted while the unit is on.

(P1, P2, P3, P4) System Pressure Input

If a pressure transducer is used with the Compressor Controller, the System Pressure Input is a measurement of the system suction pressure. For pressure transducer signal wiring, short wire runs and shielded wiring are

recommended. For best signal resolution, the smallest acceptable pressure transducer range for the refrigerant should be used. The Digital Compressor Controller provides a precision source 5VDC for the pressure transducer to accurately measure the pressure. This 5VDC source is capable of sourcing a maximum of 10mA

(P5, P6) System Pressure Output

If a pressure transducer is connected to the System Pressure Input terminals, the System Pressure Output provides an analog output of the filtered suction pressure. The Digital Compressor Controller “filters” this suction pressure by using the unloader capacity algorithm to smooth the pressure fluctuations measured by the suction pressure transducer. The output of 0 – 5VDC corresponds to the range of the pressure transducer connected to the System Pressure Input terminals. This output is capable of sourcing a maximum of 10mA.

(T1, T2) Discharge Temperature Input

The Discharge Temperature Input is a thermistor input. There is no polarity requirement for the thermistor. For thermistor signal wiring, short wire runs are recommended. For 3D Discus Digital and Scroll Digital, the cut out temperature is 268°F (131°C) and the cut in or reset temperature is 250°F (121°C). For the 4D Discus Digital, the cut out temperature is 310°F (154°C) and the cut-in temperature is 267°F (130°C). See **Table 4** for thermistor temperature/resistance values.

(A1, A2) Alarm Relay

The Alarm Relay output is a normally open, dry contact relay output. The maximum operating voltage for this relay is 250VAC or 30VDC and the maximum load is 3 A. During an alarm condition, the relay contacts close until the alarm condition ceases or power is turned off.

(M1, M2) Compressor Contactor

The compressor contactor output is a triac output. **The maximum continuous contactor coil load is 0.5A and the peak inrush current is 6A.** The maximum coil operating voltage is 24 - 250VAC. This output is incompatible with DC coil voltages. The compressor contactor is energized when there are no ALERT conditions and the demand signal is greater than 1.44VDC.

(L1, L2) Control Power

NOTE!

Control Power supplied to Digital Compressor Controller

must be the same voltage as the compressor contactor coil, unloader solenoid and vapor injection solenoid.

The Control Power requirement is a single phase, 19-250VAC, 48-62Hz source. **The control power must be isolated with a transformer from the mains power supply.** The maximum load on the control power circuit is 1.5A based on a motor contactor, unloader solenoid and vapor injection solenoid connected to the Compressor Controller.

(U1, U2) Unloader Solenoid

The Unloader Solenoid output is a triac output. The maximum continuous solenoid load is 0.5A and the peak inrush current is 6A. The maximum solenoid operating voltage is 250VAC. This output is incompatible with DC solenoid voltages. The unloader solenoid is energized in an on/off pattern to deliver the capacity requested by the demand signal.

(V1, V2) Vapor Injection Solenoid

The Vapor Injection Solenoid output is a triac output. The maximum continuous solenoid load is 0.5A. The maximum solenoid operating voltage is 250VAC and the peak inrush current is 6A. This output is incompatible with DC solenoid voltages. The vapor injection solenoid is energized whenever the compressor contactor is energized.

Compressor Start And Shut Down

The Digital Compressor Controller always unloads the compressor for 0.1 seconds at each startup. After this brief unloading period, the unloader solenoid will be deenergized and the compressor will run loaded according to the level of the Demand input signal. Each time the compressor shuts down, the Digital Compressor Controller will run the compressor unloaded for 0.5 seconds. Energizing the unloader solenoid for this period of time will allow the discharge and suction pressures to equalize, minimizing scroll reverse rotation.

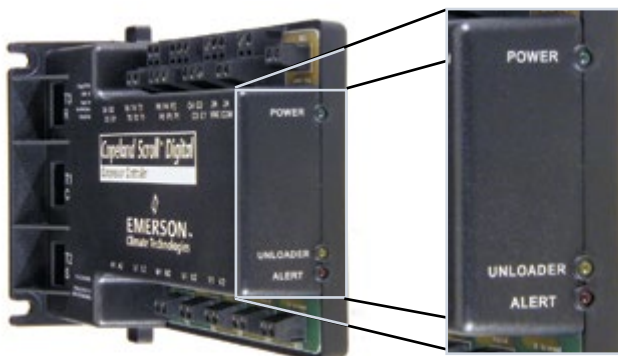

Compressor Running

The loaded/unloaded cycle always equals either 20 seconds or 15 seconds depending on the controller module. The loaded sequence always precedes the unloaded sequence. Capacity modulation is achieved by energizing and de-energizing the solenoid valve. When the solenoid valve is de-energized, the compressor capacity is 100%. When the solenoid valve is energized, the compressor capacity is zero. Therefore, the capacity achieved is the time average capacity, which is a variable from 10 – 100%.

Example of 20 second cycle: If the solenoid is de-energized (compressor loaded) for four seconds, then energized (compressor unloaded) for sixteen seconds, the resulting capacity will be 20% of full load capacity. See **Table 2**. Example of 15 second cycle: If the solenoid is de-energized (compressor loaded) for three seconds, then energized (compressor unloaded) for twelve seconds, the resulting capacity will be 20% of full load capacity. See **Table 3**.

Digital Compressor Controller LEDs

POWER LED (green) – indicates voltage is present at the 24VAC power terminals. When the anti-short cycle timer is active, the green LED will flash.

UNLOADER LED (yellow) – indicates the unloader solenoid status. This LED is on when the unloader solenoid is energized.

ALERT LED (red) – communicates an abnormal system condition through a unique flash code. *The ALERT LED will flash a number of times consecutively, pause and then repeat the process. The number of consecutive flashes, defined as the Flash Code, correlates to a particular abnormal condition.*

Flash Code Troubleshooting

While each ALERT code is active, the alarm relay contacts (A1 and A2) are closed. The ALERT code will remain active and the alarm relay contacts closed until the reset conditions have been met or 24VAC power has been cycled off and on. All Flash Codes except Code 6 and 8 result in the compressor contactor, unloader solenoid and vapor injection solenoid being deenergized. Flash codes 3, 4, 5, and 9 activate the two minute anti-cycle timer. Flash code 2 activates the 30 minute timer.

All LEDs flashing at the same rate indicates 24VAC supply is too low for operation. All LEDs on solid at the same time indicates Digital Compressor Controller failure.

Whenever power is cycled off and on, the current Flash Code and all internal counters are reset.

Flash Code 1 - Reserved for future use

Flash Code 2 - High Discharge Temperature

The discharge temperature thermistor has measured a temperature above 268°F (130°C) or the thermistor is short circuited (jumpered out).

The Digital Compressor Controller will deenergize the compressor contactor and vapor injection solenoid. The alarm relay contacts will close.

The compressor will be allowed to restart after a 30 minute delay and after the thermistor temperature is below 250°F (120°C). The flash code and alarm relay contacts will be reset after the compressor has run for 60 uninterrupted minutes without any other ALERTs.

If five high discharge temperature ALERTs have occurred within four hours, the Digital Compressor Controller will lock out the compressor. The lockout can only be reset by cycling the 24VAC power off and on.

Flash Code 3 - Compressor Protector Trip

The demand signal from the system controller is greater than 1.44VDC and there is no compressor current detected. This could be due to the compressor's internal overload protector being open, fuse or breaker open, power disconnected to compressor contactor, compressor power wiring not run through Digital Compressor Controller current transformer port or a compressor contactor failure.

The Digital Compressor Controller will deenergize the compressor contactor and vapor injection solenoid. The alarm relay contacts will close.

The Digital Compressor Controller will wait for the anti-short cycle timer to time out and if the system controller demand signal is still greater than 1.44VDC, energize the compressor contactor again. If compressor current is detected on the restart, the ALERT code and alarm relay output will reset. The Digital Compressor Controller will attempt to restart compressor as long as the system controller demand is above 1.44VDC. There is no lockout feature for this ALERT.

Flash Code 4 - Locked Rotor

A locked rotor condition in the compressor is sensed by the Digital Compressor Controller on four consecutive start ups within a 20 second period.

The Digital Compressor Controller will deenergize the compressor contactor and vapor injection solenoid. The alarm relay contacts will close.

If a low pressure cut-out device is used, the compressor could short-cycle depending on the cut-in and cut-out pressures and system configuration. This could be interpreted as a Locked Rotor fault by the Digital Controller and the compressor will get locked out.

This code results in a lockout and can only be reset by cycling the 24VAC power off and on.

Flash Code 5 - Demand Signal Loss

The demand signal input has dropped below 0.5VDC. The demand input signal wire may be disconnected or the system controller providing the signal may not be powered.

The Digital Compressor Controller will deenergize the compressor contactor and vapor injection solenoid. The alarm relay contacts will close.

Once the system controller demand signal input has risen above 0.5VDC, the ALERT code and alarm relay output will reset. If the demand signal is above 1.44VDC and the anti-short cycle timer has timed out, the compressor will restart. There is no lockout feature for this ALERT.

Flash Code 6 - Discharge Thermistor Fault

The Digital Compressor Controller is not receiving a signal from the discharge temperature thermistor. The thermistor may be missing, disconnected or a wire is broken.

The alarm relay contacts will close and the Digital Compressor Controller will not increase the capacity of the compressor beyond 50% loading.

This ALERT code and alarm relay output are reset by reconnecting the thermistor.

Flash Code 7 - Unloader Solenoid Fault

Reserved for future use

Flash Code 8 - Compressor Contactor Fault

Compressor current is detected when the system controller demand signal is below 1.44VDC. The compressor contactor may have welded contacts or the contacts may be mechanically jammed. The compressor will continue to run in this condition since the Digital Compressor Controller cannot open the compressor contactor.

The Digital Compressor Controller will energize the compressor contactor and vapor injection solenoid. The alarm relay contacts will close. The unloader solenoid will remain energized causing the compressor to run unloaded as long as the system controller demand signal is less than 1.44VDC. If the system controller demand is greater than 1.44VDC, the unloader solenoid will deenergize causing the compressor to run loaded.

The ALERT code and alarm relay output are reset when current is no longer detected while system controller demand signal is below 1.44VDC.

Flash Code 9 - Low 24VAC Supply

Supply voltage to the Digital Compressor Controller has dropped below 18.5VAC.

The Digital Compressor Controller will deenergize the compressor contactor, unloader solenoid and vapor injection solenoid. The alarm relay contacts may close if the voltage is high enough for the alarm relay to pull in.

The ALERT code and alarm relay output are reset when the supply voltage to the Digital Compressor Controller rises above 19.5VAC.

OEM Testing

The Digital Compressor Controller can remain in circuit during factory hi-pot testing. The maximum hi-pot test voltage that should be applied between ground and the 24VAC Low Voltage Inputs and Outputs is 600VAC. The maximum hi-pot test voltage that should be applied between the High Voltage Control and High Voltage Outputs is 2500VAC. The normal leakage current should be less than 200 microamps.

Testing the Installed Digital Compressor Controller

Once installed, the Digital Compressor Controller can be tested to verify it is working properly. In each test, 24VAC must be supplied to 24VAC and 24COM. For the output test, 24-250VAC must be supplied to L1 and L2.

Input Tests

Thermistor Input – disconnect the discharge temperature sensor wires from terminals T1 and T2. If functioning normally, the Digital Compressor Controller should display a Code 6 unless a previous ALERT code was present.

Demand Input – disconnect the System Controller Demand signal wires from C1 and C2. If functioning normally, the Digital Compressor Controller should display a Code 5 unless a previous ALERT code was present.

Output Tests

Contactor Output – while the Digital Compressor Controller is powered off (no supply voltage to 24VAC and 24COM), disconnect the System Controller Demand signal wire from C1 and C2. Add a jumper wire from P3 to C2 and a second jumper wire from P1 to C1. Reapply power to 24VAC and 24COM. If functioning normally, a voltmeter should read the same voltage across M1 and M2 as is measured across L1 and L2, unless an ALERT code is present.

Unloader Output – while Digital Compressor Controller is modulating the unloader solenoid, a voltmeter should read the same voltage across U1 and U2 as is measured across L1 and L2 whenever the yellow “Unloader” LED is lit.

Demand Cooling with Copeland Digital Compressor Controller

The digital compressor controller has its own discharge temperature protection. However, for applications requiring Demand Cooling, the Demand Cooling module should have primary control of the temperature protection. To ensure the Demand Cooling system functions appropriately, jumper the T1 and T2 inputs on the Digital Compressor Controller, with a 5kOhm, 1 Watt resistor.

For more information regarding Copeland Demand Cooling, refer to **AE4-1327**, Economized Vapor Injection (EVI) Compressors, and/or **AE4-1287**, Copeland Discus Demand Cooling.

**Figure 3
Compressor Controller Wiring Diagram**

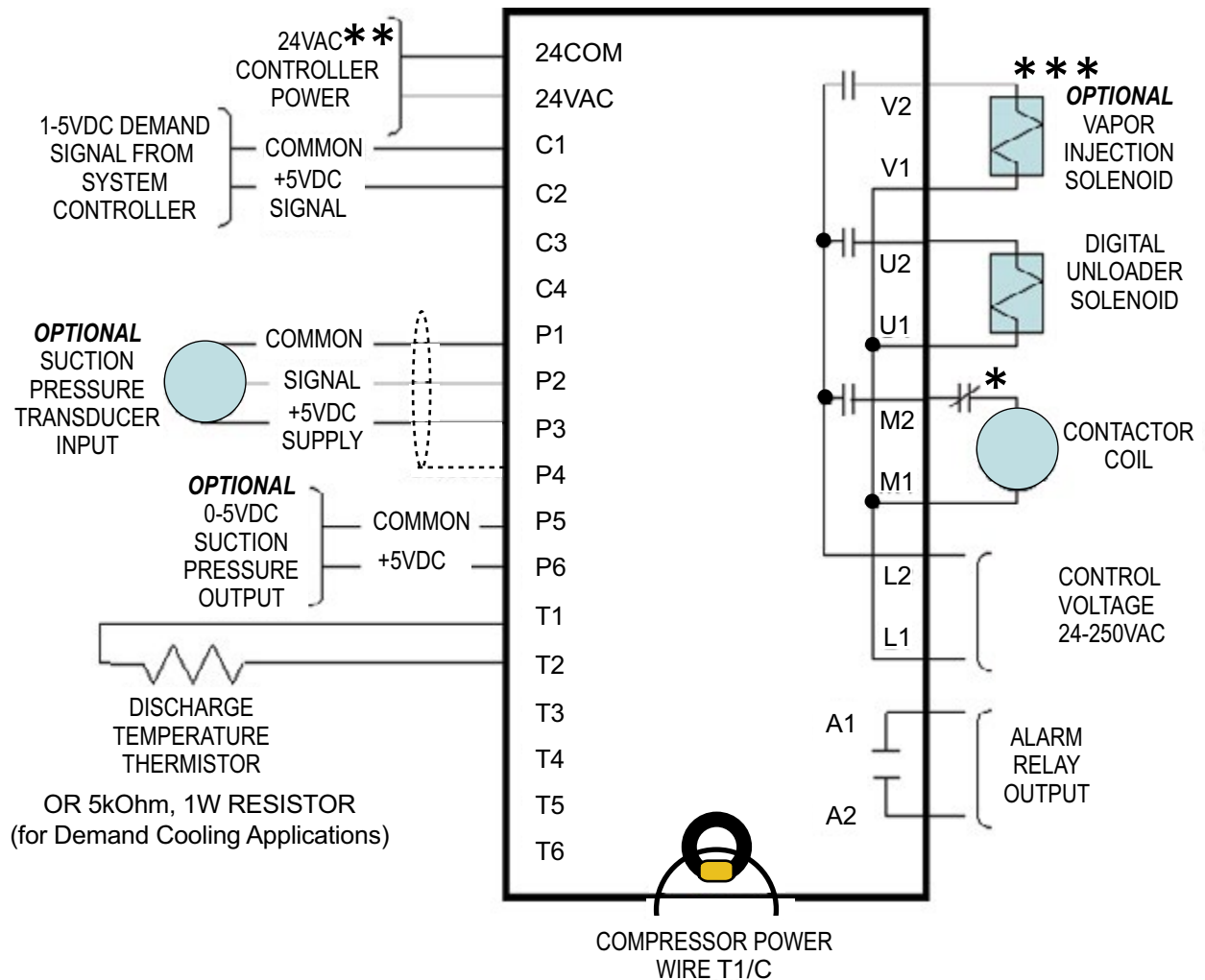

Note: The L1, M1, U1, and V1 are connected together inside the module.

Note: For 110V control circuits, it is suggest to connect the incoming control power (110V) to L2 and connect the unpowered wire (Neutral) to L1. This wiring method is to prevent having 110V at the coils when the module relays are not closed.

BULLETIN

**Table 1
Digital Compressor Controllers**

Part No.	“Duty Cycle Time (sec)”	2-Minute Anti Short Cycle Timer Delay	Application
543-0024-00	20	Yes	Refrigeration - Scroll
543-0024-01	15	Yes	Air Conditioning - Scroll
543-0086-01	20	No	Refrigeration - Scroll & Discus® (3D)
543-0088-00	20	No	Refrigeration - Discus® (4D)

**Table 2
Digital Compressor Controller Differences**

Features	Digital Compressor Controller Part Number			
	543-0024-00	543-0024-01	543-0086-01	543-0088-00
High Discharge Temperature	>268F, Lockout on 5th	>268F, Lockout on 5th	>268F, No Lockout	>310F, No Lockout
Protector Trip	2min Off Time	2min Off Time	6sec Off Time	6sec Off Time
Locked Rotor	Lockout on Detection	Lockout on Detection	No Lockout, 30min Offtime	No Lockout, 30min Offtime
Demand Signal Loss	Demand < 0.5V	Demand < 0.5V	Demand < 0.5V	Demand < 0.5V
Discharge Thermistor Fault	Limit Capacity To 50%	Limit Capacity To 50%	No Capacity Limit	No Capacity Limit
Welded Contactor	Detection In 2Secs	Detection In 2Secs	Detection In 30Secs	Detection In 30Secs
Low Voltage	Supply voltage < 19VAC	Supply voltage < 19VAC	Supply voltage < 19VAC	Supply voltage < 19VAC
Anti-Short Cycling Time	2min OFFtime	2min OFFtime	6secs OFFtime	6secs OFFtime
Modulation Range	10% To 100%	10% To 100%	10% To 100%	50% To 100%
Duty Cycle Time	20secs	15secs	20secs	20secs

**Table 3
20 Second Cycle Controller: 543-0024-00 20; 543-0086-01**

Demand Signal (VDC)	Loaded %	Unloaded%	Time Loaded	Time Unloaded	% Digital Compressor Capacity
1.00	Off	Off	Off	Off	0%
1.44	10%	90%	2 seconds	18 seconds	10%
3.00	50%	50%	10 seconds	10 seconds	50%
4.20	80%	20%	16 seconds	4 seconds	80%
5.00	100%	0%	20 seconds	0 seconds	100%

Table 4
15 Second Cycle Controller: 543-0024-01

Demand Signal (VDC)	Loaded %	Unloaded%	Time Loaded	Time Unloaded	% Digital Compressor Capacity
1.00	Off	Off	Off	Off	0%
1.44	10%	90%	1.5 seconds	13.5 seconds	10%
3.00	50%	50%	7.5 seconds	7.5 seconds	50%
4.20	80%	20%	12 seconds	3 seconds	80%
5.00	100%	0%	15 seconds	0 seconds	100%

Table 5
20 Second Cycle Controller: 543-0088-00

Demand Signal (VDC)	Loaded %	Unloaded%	Time Loaded	Time Unloaded	% Digital Compressor Capacity
1	Off	Off	Off	Off	0%
2.9	0%	100%	0 seconds	20 seconds	50%
3.42	25%	75%	5 seconds	15 seconds	63%
3.95	50%	50%	10 seconds	10 seconds	75%
5	100%	0%	20 seconds	0 seconds	100%

* Note! Only one bank of a 4D Discus Digital modulates. Therefore, unless the compressor is completely off (1.00 V or less to Digital Compressor Controller) at least 50% capacity will be provided by the 4D compressor at all times.

Table 6
Thermistor Temperature/Resistance Values

Deg C	Deg F	Resistance (kOhms)
-40	-40	2889.60
-35	-31	2087.22
-30	-22	1522.20
-25	-13	1121.44
-20	-4	834.72
-15	5	627.28
-10	14	475.74
-5	23	363.99
0	32	280.82
5	41	218.41
10	50	171.17
15	59	135.14
20	68	107.44
25	77	86.00
30	86	69.28
35	95	56.16
40	104	45.81
45	113	37.58
50	122	30.99
55	131	25.68
60	140	21.40
65	149	17.91

Deg C	Deg F	Resistance (kOhms)
70	158	15.07
75	167	12.73
80	176	10.79
85	185	9.20
90	194	7.87
95	203	6.77
100	212	5.85
105	221	5.09
110	230	4.45
115	239	3.87
120	248	3.35
125	257	2.92
130	266	2.58
135	275	2.28
140	284	2.02
145	293	1.80
150	302	1.59
155	311	1.39
160	320	1.25
165	329	1.12
170	338	1.01
175	347	0.92
180	356	0.83

Figure 4
Demand Signal Vs. Modulation Graph
(P/N 543-0024-00, 543-0024-01, & 543-0086-01)

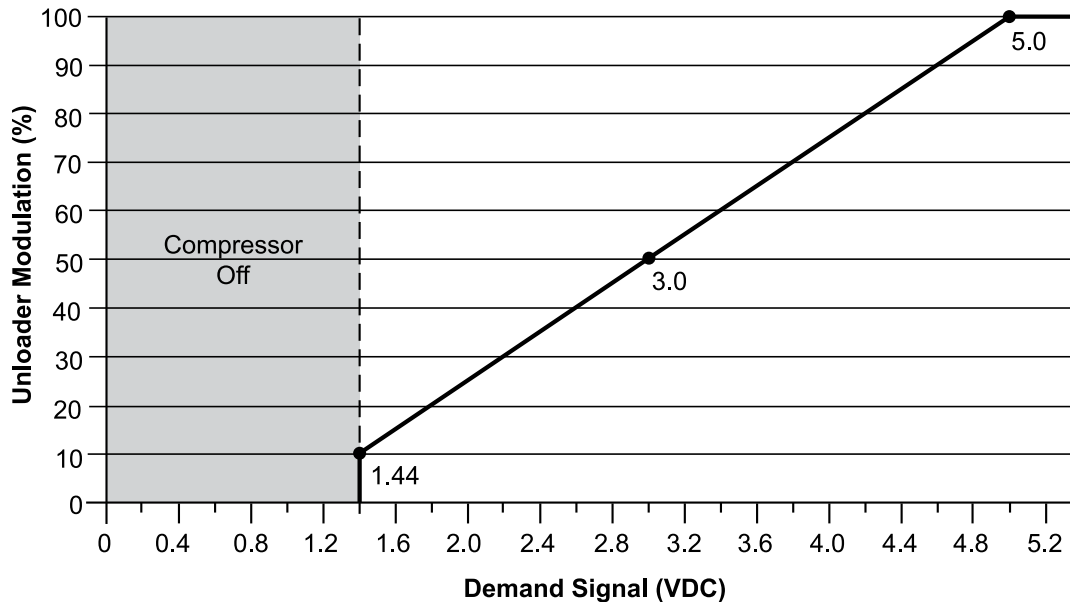

Figure 5
Demand Signal vs. Modulation Graph (P/N 543-0088-00)

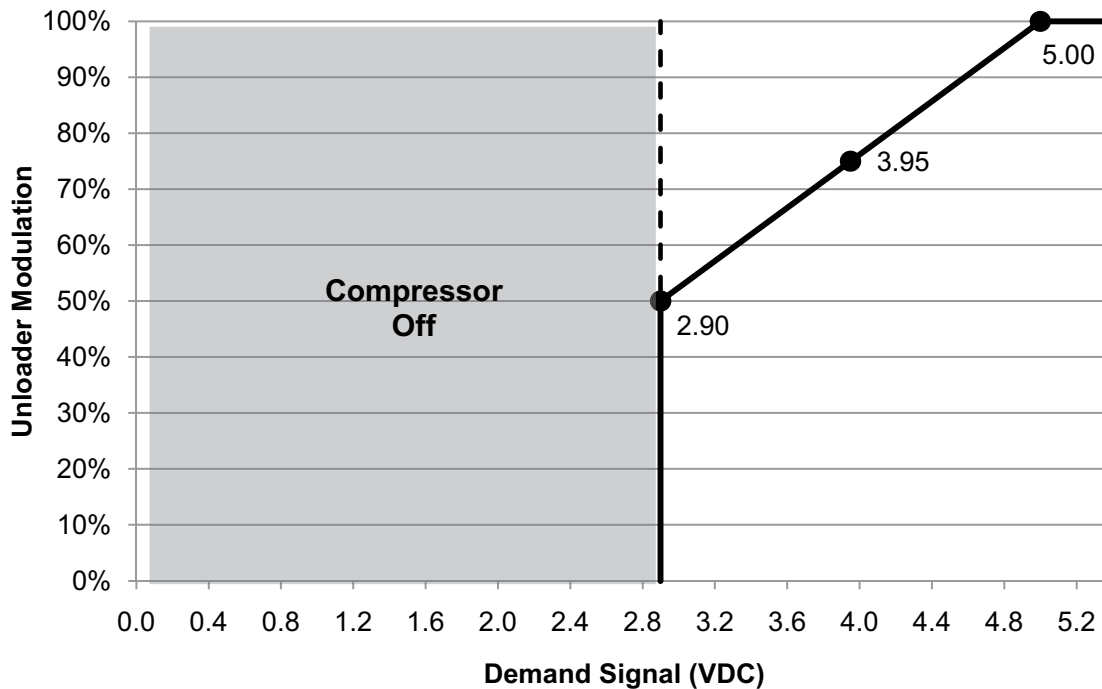



Figure 6

Service Panel Label (Form 052-2401-00) For Controller Part No. 543-0024-00 and 543-0024-01

Copeland Scroll Digital™ Compressor Controller



Low Voltage Terminals	LED Descriptions	Troubleshooting ALERT Flash Codes
<p>24 COM Module Power 24 VAC Module Power C1 Demand Input - C2 Demand Input + P1 Pressure Common P2 Pressure Input P3 Pressure Power 5VDC P4 Pressure Shield P5 Pressure Output - P6 Pressure Output + T1 Discharge Temp Sensor T2 Discharge Temp Sensor</p> <p>High Voltage Terminals A1 Alarm Relay Out A2 Alarm Relay Out L1 Control Voltage L2 Control Voltage M1 Contactor M2 Contactor U1 Unloader Solenoid U2 Unloader Solenoid V1 Vapor Injection Solenoid V2 Vapor Injection Solenoid</p> <p>All high voltage terminals rated 24-250 VAC</p>	<p>Green LED - 24VAC Power Yellow LED - Unloader Solenoid On Red LED - ALERT Flash Code</p> <ul style="list-style-type: none"> • Flashing Green LED indicates anti-short cycle timer active • All LEDs flashing at same rate indicates 24VAC supply too low for operation • All LEDs solid at same time indicates controller failure • Reset ALERT code or lockout by removing 24VAC supply to module • All ALERTs close alarm relay contacts • All ALERTs deenergize contactor and solenoids except Code 6 • Compressor always unloads for 0.1 second at startup • Compressor only starts when Demand signal input is above 1.45 VDC and no ALERTs are present 	<p>Code 1 Reserved for future use</p> <p>Code 2 High Discharge Temperature Discharge thermistor above trip set point or thermistor short circuited. Resets after 30 minutes and motor cools down. If 5 events occur within 4 hours, the compressor is locked out.</p> <p>Code 3 Compressor Protector Trip No compressor current is detected when compressor should be running. Resets when compressor current is detected.</p> <p>Code 4 Locked Rotor Locked rotor condition is detected. Compressor is locked out.</p> <p>Code 5 Demand Signal Loss Demand input signal is below 0.5VDC. Resets after demand input signal rises above 1.0VDC.</p> <p>Code 6 Discharge Thermistor Fault Thermistor is not connected. Reset by reconnecting thermistor.</p> <p>Code 7 Reserved for future use</p> <p>Code 8 Compressor Contactor Fault Compressor current is detected when compressor should be off. Resets when current is no longer detected.</p> <p>Code 9 Low 24VAC Supply Supply voltage to module has dropped below 18.5VAC. Resets after voltage rise above 19.5VAC.</p>

For More Information:
EmersonClimate.com
Online Product Information (OPI)
AE Bulletin AE8-1328

Part Number
052-2401-00 Rev. 0

Emerson and Copeland are trademarks of Emerson Electric Co. or one of its affiliated companies.
© 2003 Emerson Climate Technologies, Inc. All rights reserved.

Figure 7

Service Panel Label (Form 052-2402-00) For Controller Part No. 543-0086-01 and 543-0088-00

Copeland™ 4D Digital Compressor Controller



Low Voltage Terminals	LED Descriptions	Troubleshooting ALERT Flash Codes
<p>24 COM Module Power 24 VAC Module Power C1 Demand Input - C2 Demand Input + P1 Pressure Common P2 Pressure Input P3 Pressure Power 5VDC P4 Pressure Shield P5 Pressure Output - P6 Pressure Output + T1 Discharge Temp Sensor T2 Discharge Temp Sensor</p> <p>High Voltage Terminals A1 Alarm Relay Out A2 Alarm Relay Out L1 Control Voltage L2 Control Voltage M1 Contactor M2 Contactor U1 Unloader Solenoid U2 Unloader Solenoid V1 Vapor Injection Solenoid V2 Vapor Injection Solenoid</p> <p>All high voltage terminals rated 24-250 VAC</p>	<p>Green LED - 24VAC Power Yellow LED - Unloader Solenoid On Red LED - ALERT Flash Code</p> <ul style="list-style-type: none"> • Flashing Green LED indicates anti-short cycle timer active • All LEDs flashing at same rate indicates 24VAC supply too low for operation • All LEDs solid at same time indicates controller failure • Reset ALERT code by removing 24VAC supply to module • All ALERTs close alarm relay contacts • All ALERTs deenergize contactor and solenoids except Code 6 • Compressor always unloads for 0.1 second at startup • Compressor only starts when Demand signal input is above 1.45 VDC and no ALERTs are present 	<p>Code 1 Reserved for future use</p> <p>Code 2 High Discharge Temperature Discharge thermistor above trip set point or thermistor short circuited. Resets after 30 minutes and motor cools down.</p> <p>Code 3 Compressor Protector Trip No compressor current is detected when compressor should be running. Resets when compressor current is detected.</p> <p>Code 4 Locked Rotor Locked rotor condition is detected. Reset after 30 minutes.</p> <p>Code 5 Demand Signal Loss Demand input signal is below 0.5VDC. Resets after demand input signal rises above 1.0VDC.</p> <p>Code 6 Discharge Thermistor Fault Thermistor is not connected. Reset by reconnecting thermistor.</p> <p>Code 7 Reserved for future use</p> <p>Code 8 Compressor Contactor Fault Compressor current is detected when compressor should be off. Resets when current is no longer detected.</p> <p>Code 9 Low 24VAC Supply Supply voltage to module has dropped below 18.5VAC. Resets after voltage rise above 19.5VAC.</p>

For More Information:
EmersonClimate.com
Online Product Information (OPI)
AE Bulletin AE8-1328

Part Number
052-2402-00 Rev. 0

Emerson and Copeland are trademarks of Emerson Electric Co. or one of its affiliated companies.
© 2003 Emerson Climate Technologies, Inc. All rights reserved.