

Machinery Health™ System

A6500-RC Relay Card



Copyright

© 2024, Emerson. All rights reserved.

No part of this publication may be reproduced, transmitted, transcribed, stored in a retrieval system, or translated into any language in any form by any means without the written permission of Emerson.

Disclaimer

This manual is provided for informational purposes. EMERSON MAKES NO WARRANTY OF ANY KIND WITH REGARD TO THIS MATERIAL, INCLUDING, BUT NOT LIMITED TO, THE IMPLIED WARRANTIES OF MERCHANTABILITY AND FITNESS FOR A PARTICULAR PURPOSE. Emerson shall not be liable for errors, omissions, or inconsistencies that may be contained herein or for incidental or consequential damages in connection with the furnishing, performance, or use of this material. Information in this document is subject to change without notice and does not represent a commitment on the part of Emerson. The information in this manual is not all-inclusive and cannot cover all unique situations.

Patents

The product(s) described in this manual are covered under existing and pending patents.

-  Vermerk zur Installation der Messketten in explosionsgefährdeter Umgebung.
Soll die Messkette in explosionsgefährdeter Umgebung installiert werden, so ist auf die Einhaltung der in der Gebrauchsanweisung enthaltenen Installationshinweise zu achten. Sollten dabei sprachliche Schwierigkeiten auftreten, wenden Sie sich bitte an die Herstellerfirma, sie wird Ihnen eine Übersetzung der relevanten Artikel in der Landessprache des Verwendungslandes zukommen lassen.
-  Nota fuq l-installazzjoni tal-ktajjen tal-kejl f'ambjent esploziv
Jekk il-katina tal-kejl suppost li tigi installata f'ambjent esploziv, hu importanti li ssegwi l-istruzzjonijiet pertinenti tal-manwal. Jekk issib xi diffikultà bil-lingwa, jekk joghgbok ikkuntattja lill-manifattur biex tikseb traduzzjoni tal-paragrafi rilevanti fil-lingwa mehtiega.
-  Anmärkning beträffande installation av mätkedjorna i explosionsfarlig miljö.
Ska mätkedjan installeras i explosionsfarlig miljö, måste de anvisningar följas som ges i instruktionsboken beträffande installationen. Skulle därvid språkproblem uppstå, ber vi dig kontakta det tillverkande företaget som då kommer att sända dig en översättning av de relevanta artiklarna på användningslandets språk.
-  Opomba za namestitve merilne verige v eksplozivno ogroženem okolju
Èe se merilna veriga namešèa v eksplozivno ogroženem okolju, je potrebno upoštevati namestitvena opozorila, ki so v Navodilih za uporabo. Èe se pri tem pojavijo jezikovne težave, se posvetujte z izdelovalcem; poslali vam bodo prevod ustreznih èlankov v jeziku države, kjer se naprava uporablja.
-  Záznam k inštalácii meracích reťazcov vo výbušnom prostredí
Ak má byť merací reťazec inštalovaný vo výbušnom prostredí, treba dbať na dodržiavanie pokynov k inštalácii, uvedených v návode na použitie. V prípade, že by sa pritom vyskytli jazykové problémy, obráťte sa prosím na výrobcu, ktorý Vám zašle preklad relevantných èlánkov v jazyku Vašej krajiny.
-  Nota referente à instalação de cadeias de agrimensur em ambientes potencialmente explosivos
Caso a cadeia de agrimensur deva ser instalada em um ambiente potencialmente explosivo, é imprescindível observar e cumprir as indicações de instalação das instruções de serviço. Caso tenha dificuldades idiomáticas, queira entrar em contato com a firma produtora, esta poderá enviar-lhe uma tradução dos capítulos mais importantes no idioma do país onde o produto deverá ser empregado.
-  Wskazówka dotycząca instalacji łańcuchów mierniczych w otoczeniach zagrożonych eksplozją.
Jeżeli łańcuch mierniczy ma być zainstalowany w otoczeniu zagrożonym eksplozją, należy uwzględnić wskazówki dotyczące instalacji, które są zawarte w instrukcji obsługi. Jeżeli w trakcie lektury wystąpią jakiegokolwiek problemy związane ze zrozumieniem tekstu, prosimy zwrócić się do producenta, który chętnie wykona tłumaczenie wybranych części dokumentacji na język danego kraju.



Opmerking m.b.t. installatie van elektrische meet circuits in explosiegevaarlijke omgeving

Dient de installatie van elektrische meet circuits in een explosiegevaarlijke omgeving te geschieden, moet men toezien dat de in de gebruikshandleiding opgenomen installatieinstructies worden nageleefd. Bij taalkundige problemen gelieve contact op te nemen met de fabrikant, deze zal u vervolgens een vertaling in de taal van het gebruiksland doen toekomen.



Pastaba dėl matavimo grandinės įrengimo sprogimo atžvilgiu pavojingoje aplinkoje

Jei matavimo grandinė turi būti įrengta sprogimo atžvilgiu pavojingoje aplinkoje, privaloma laikytis vartotojo instrukcijose pateiktų įrengimo nurodymų. Jei kiltų sunkumų dėl kalbos, prašome kreiptis į gamintojo įmonę, kuri pateiks Jums reikiamo skyriaus vertimą į vartotojo valstybės kalbą.



Nota sull'installazione delle catene per misurazione in ambienti a rischio di esplosioni

Nel caso in cui si debbano installare le catene per misurazione in ambienti a rischio di esplosioni, è necessario attenersi alle avvertenze per l'installazione contenute nelle istruzioni d'uso. Per difficoltà di carattere linguistico, rivolgetevi alla ditta produttrice. Quest'ultima Vi farà pervenire una traduzione degli articoli rilevanti nella lingua del paese d'impiego.



Megjegyzés a mérőláncok robbanásveszélyes környezetben történő szereléséhez.

Ha a mérőláncot robbanásveszélyes környezetben kell felszerelni, akkor ügyeljen a Használati útmutatóban közölt szerelési utasítások betartására. Amennyiben nyelvi nehézségek merülnek fel, szíveskedjen a gyártó céghez fordulni, amely elküldni Önnek a felhasználó ország nyelvére lefordított, erre vonatkozó cikket.



Remarque concernant l'installation des chaînes de mesure dans un environnement présentant un risque d'explosion

Si la chaîne de mesure doit être installée dans un environnement présentant un risque d'explosion, il est impératif de veiller à respecter les consignes d'installation contenues dans les instructions de service. S'il devait ce faisant surgir des problèmes linguistiques, veuillez vous adresser à la société fabricante: elle vous fera parvenir une traduction des articles significatifs dans la langue du pays de mise en oeuvre.



Huomautus mittausketjun asentamisesta räjähdysalttiissa ympäristössä

Jos mittausketju tulee asentaa räjähdysalttiissa ympäristössä, on käyttöohjeessa annettuja asennusohjeita noudatettava. Jos käyttöohjeessa käytetty kieli aiheuttaa ongelmia, kääntykää valmistajayrityksen puoleen. Se toimittaa käyttöönnne tarvittavat artikkelit käyttömaan viralliselle kielelle käännettynä.



Juhend mõõdukettide ülespanemiseks plahvatusohtlikus piirkonnas.

Kui panna üles mõõdukettid plahvatusohtlikkus piirkonnas, nii tuleb jälgida kasutusjuhendis sisalduvad instalationimärkmeid. Juhul kui tekkivad raskused keelega, siis pöörduge palun tootja poole. Tootja saadab emakeelse tõlge vastavalt artiklile ning maale.



Notas sobre la instalación de cadenas de medición en un entorno potencialmente explosivo.

Si ha de instalar la cadena de medición en un entorno potencialmente explosivo, deberá respetar las indicaciones sobre la instalación, contenidas en el manual de uso. Si surgieran dificultades lingüísticas, póngase en contacto con la empresa fabricante, que le facilitará una traducción del artículo en la lengua del país donde se emplee.



Note on the installation of the measuring chains in an explosive environment

If the measuring chain is supposed to be installed in an explosive environment, it is important to follow the pertinent installation instructions in the manual. Should you encounter difficulties with the language, please contact the manufacturer to obtain a translation of the relevant paragraphs into the language required.



Σημείωση για την εγκατάσταση αλισιδών μέτρησης σε περιβάλλον, στο οποίο υπάρχει κίνδυνος έκρηξης
Εάν η αλισουδα μέτρησης πρόκειται να εγκατασταθεί σε περιβάλλον, στο οποίο υπάρχει κίνδυνος έκρηξης, πρέπει να τηρηθούν οπωσδήποτε οι οδηγίες εγκατάστασης που περιλαμβάνονται στις οδηγίες Χρήσης. Εάν υπάρχουν γλωσσικές δυσκολίες καταούησης, παρακαλούμε να απευθυνθείτε στην κατασκευάστρια εταιρεία, η οποία θα φρουτίσει για την αποστολή μιας μετάφρασης των σχετικών άρθρων στη γλώσσα της Χώρας Χρήσης.



Info vedrørende installation af målekæderne i eksplosionstruede omgivelser

Hvis målekæden skal installeres i eksplosionstruede omgivelser, skal installationsanvisningerne i brugsanvisningen følges. Hvis der i denne forbindelse opstår sproglige problemer, bedes De henvende Dem til produktionsfirmaet, som så vil sørge for, at De modtager en oversættelse af den relevante artikel på Deres sprog.



Poznámka k instalaci měřicích řetězců v prostředí s nebezpečím výbuchu.

Když má být měřicí řetězec (sestavující z čidla a konvertoru) instalován v prostředí s nebezpečím výbuchu, tak je třeba respektovat instalační pokyny, které jsou součástí návodu k upotřebení. Kdyby při tom došlo k jazykovým potížím, tak prosíme kontaktujte výrobní firmu, která Vám relevantní články zašle v jazyku krajiny použití.



Piezīme par mērišanas ķēžu instalēšanu sprādziena bīstamās zonās.

Ja mērišanas ķēde jāuzstāda sprādzienbīstamā zonā, ir jāievēro lietošanas instrukcijā dotie instalēšanas norādījumi. Ja rodas kādas valodas grūtības, lūdzu griezieties pie izgatavotāja firmas, kas Jums nosūtīs nozīmīgāko nodaļu tulkojumus lietotāja valstī valodā.

Emerson
epro GmbH
Jöbkesweg 3
48599 Gronau
Germany
T +49 2562 709 0
F +49 2562 709 401
www.Emerson.com

Contents

Chapter 1	General.....	7
	1.1 Using this manual.....	7
	1.2 Symbols.....	7
	1.3 Liability and guarantee.....	8
	1.4 Incoming goods inspection.....	8
	1.5 Technical support.....	8
	1.6 Storage and transport.....	9
	1.7 Disposal of the device.....	9
	1.8 China RoHS Compliance.....	9
	1.9 CCC Certification – AMS 6500 ATG.....	10
Chapter 2	Safety instructions.....	11
	2.1 Using the device.....	11
	2.2 Owner's responsibility.....	11
	2.3 Radio interference.....	12
	2.4 ESD safety.....	12
Chapter 3	Application and design.....	13
	3.1 Application.....	13
	3.2 Design.....	13
Chapter 4	Installation.....	16
	4.1 CSA - General safety.....	16
	4.2 Commissioning.....	16
Chapter 5	Hazardous location installation.....	17
Chapter 6	Configuration.....	18
	6.1 General configuration procedure.....	18
	6.1.1 Offline configuration.....	18
	6.1.2 Online configuration.....	19
	6.2 Start of an offline card configuration.....	19
	6.3 Start of an online card configuration.....	21
	6.4 Configuration of an already existing card.....	21
	6.5 Configuration editor and parameters.....	22
	6.5.1 Ribbon command bar.....	22
	6.5.2 Basic.....	28
	6.5.3 Module 1 to Module 32	29
	6.6 Send and reload a configuration.....	54
	6.6.1 Send a configuration.....	54
	6.6.2 Reload a configuration.....	56
Chapter 7	Online View.....	57

	7.1 Overview.....	58
	7.2 Details.....	60
	7.3 Online commands.....	61
Chapter 8	Functional check and maintenance.....	62
	8.1 Functional check.....	62
	8.1.1 Simulation by using a F48 extension card.....	62
	8.1.2 Simulation by using the installed cards.....	64
	8.2 Maintenance.....	64
Chapter 9	Card replacement.....	65
Chapter 10	Technical data.....	66
	10.1 Power supply.....	66
	10.2 Digital input.....	66
	10.3 Relay output.....	66
	10.4 Data interface.....	67
	10.5 Mechanical design and environmental conditions.....	67
Chapter 11	Certificates.....	69
Appendix A	Card related system events.....	80
Index	82

1 General

1.1 Using this manual

This manual contains information concerning the use of the device.

Read the operating manual completely prior to starting installation and operating the device. Comply with all safety instructions.

This operating manual applies for A6500-RC Relay Cards with hardware revisions and software versions listed in [Table 1-1](#).

Table 1-1: Hardware and software revisions

Hardware revision	Firmware version	AMS Machine Studio version
05, 06, 07, 08, and 09 ¹	3.x ²	3.8

¹ See type plate for revision level.

² Requires an A6500-CC with firmware version 3.x.

Include the operating manual when transferring the device to third parties.

Note

When requesting technical support, please indicate type and serial number from the type plate.

[Table 1-2](#) shows a list of documents that are referred to in this operating manual.

Table 1-2: Referenced documents

MHM-97875	Operating Manual A6500-CC Com Card
MHM-97877	Operating Manual A6500-xR System Racks
MHM-97879	Operating Manual AMS Machine Studio - General Functions

1.2 Symbols

Note



This symbol marks passages that contain important information.

CAUTION

This symbol marks operations that can lead to malfunctions or faulty measurements, but will not damage the device.

DANGER

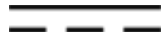
A danger indicates actions that can lead to property damage or personal injury.

	According to IEC 61010, this symbol means that this device must be operated with DC voltage.
	Warning, electric shock hazard.
	According to IEC 61010, this symbol means that the documentation of the device must completely be read and understood before installing and commissioning of the device. Observe all safety related instructions in this document.

1.3 Liability and guarantee

Emerson is not liable for damages that occur due to improper use. Proper use also includes the knowledge of, and compliance with, this document.

Customer changes to the device that have not been expressly approved by Emerson will result in the loss of guarantee.

Due to continuous research and further development, Emerson reserves the right to change technical specifications without notice.

1.4 Incoming goods inspection

Check the content of the shipment to ensure that it is complete; visibly inspect the goods to determine if the device has been damaged during transport. The following parts are included in the scope of delivery and must be contained in the shipment.

- A6500-RC Relay Card
- Operating manual

If the contents are incomplete, or if you observe any defects, file a complaint with the carrier immediately. Inform the responsible Emerson sales organization so your device can be replaced. In this case, attach a tag with customer name and the observed defect.

1.5 Technical support

You may need to ship this product for return, replacement, or repair to an Emerson Product Service Center. Before shipping this product, contact Emerson Product Support to obtain a Return Materials Authorization (RMA) number and receive additional instructions.

Product Support

Emerson provides a variety of ways to reach your Product Support team to get the answers you need when you need them:

Phone Toll free 1 800 833 8314 (U.S. and Canada)

+1 512 832 3774 (Latin America)
+63 2 8702 1111 (Asia Pacific, Europe, and Middle East)

Email Guardian.GSC@Emerson.com

Web <http://www.emerson.com/en-us/contact-us>

To search for documentation, visit <http://www.emerson.com>.

To view toll free numbers for specific countries, visit <http://www.emerson.com/technicalsupport>.

Note

If the equipment has been exposed to a hazardous substance, a Material Safety Data Sheet (MSDS) must be included with the returned materials. An MSDS is required by law to be available to people exposed to specific hazardous substances.

1.6 Storage and transport

Store and transport the device only in its original packaging. Technical data specifies the environmental conditions for storage and transport.

Related information

[Technical data](#)

[Power supply](#)

[Digital input](#)

[Relay output](#)

[Data interface](#)

[Mechanical design and environmental conditions](#)

1.7 Disposal of the device

Provided that no repurchase or disposal agreement exists, recycle the following components at appropriate facilities:

- Recyclable metal
- Plastic elements

Sort the remaining components for disposal, based on their condition. National laws or provisions on waste disposal and protection of the environment apply.

Note

Environmental hazards! Electrical waste and electronic components are subject to treatment as special waste and may only be disposed by approved specialized companies.

1.8 China RoHS Compliance

Our products manufactured later than June 30, 2016, and those which are sold in the People's Republic of China are marked with one of the following two logos to indicate the

Environmental Friendly Use Period in which it can be used safely under normal operating conditions.

Products that do not have the following marking were either manufactured before June 30, 2026, or are not electrical equipment products (EEP).



Circling arrow symbol with "e": The product contains no hazardous substances over the Maximum Concentration Value and it has an indefinite Environmental Friendly Use Period.



Circling arrow symbol with a number: This product contains certain hazardous substances over the Maximum Concentration Value and it can be used safely under normal operating conditions for the number of years indicated in the symbol. The names and contents of hazardous substances can be found in chapter "Certificates".

1.9 CCC Certification – AMS 6500 ATG

With the announcement of the Chinese market regulation authority SAMR (State Administration for Market Regulation), a Compulsory Product Certification (CCC certification) is mandatory for many explosion protection products. This explosion proof ("Ex") product complies to the CCC obligation and is certified (certification number: 2020322304002386).



This China Compulsory Certificate mark (CCC), is a compulsory safety mark for many products imported, sold, or used in the Chinese market and indicates that the product is certified in accordance to GB/T 3836.1-2021, GB/T 3836.3-2021, and GB/T 3836.8-2021. If the product label is too small to contain the CCC certification mark, it is sufficient to have the mark printed on the minimum package and in the attached document.

2 Safety instructions

To ensure safe operation, carefully follow all the instructions in this manual.

The correct and safe use of this device requires that both operating and service personnel understand and comply with general safety guidelines and observe the special safety comments listed in this manual. Where necessary, safety-sensitive points on the device are marked.

⚠ DANGER

Because the device is electrical equipment, only specially trained and authorized personnel may commission, service, and maintain this equipment.

2.1 Using the device

Install and use the device as specified in this document.

If the device is used in a manner not specified by the manufacturer, the functions and protection provided by the device may be impaired.

2.2 Owner's responsibility

If there is a reason to suspect that hazard-free operation, and thus, adequate machine protection is no longer possible, take the device out of operation and safeguard it from unintentional operation. This is the case:

- if the device shows visible damage.
- if the device no longer works.
- after any kind of overload that has exceeded the permissible limits (see technical data of the device for permissible limits).

⚠ DANGER

If device tests have to be completed during operation or if the device has to be replaced or decommissioned, it will impair the machine protection and may cause the machine to shut down. Make sure to deactivate machine protection before starting such work, and reactivate it after work has been completed.

Related information

[Technical data](#)

[Power supply](#)

[Digital input](#)

[Relay output](#)

[Data interface](#)

[Mechanical design and environmental conditions](#)

2.3 Radio interference

The device is carefully shielded and tested to be technically immune to radio interference and complies with current standards. However, if you operate this device together with other peripheral devices that are not properly shielded against radio interference, disturbances and radio interferences may occur.

2.4 ESD safety

DANGER

Internal components can be damaged or destroyed due to electrostatic discharge (ESD) during the handling of the device.

Take suitable precautions before handling the device to prevent electrostatic discharges through the electronics. Such measures might include, for example, wearing an ESD bracelet. Transport and storage of electronic components may only be made in ESD-safe packaging.

Handle the device with particular care during dry meteorological conditions with relative humidity below 30% as electrostatic discharges can occur more frequently.

3 Application and design

3.1 Application

The A6500-RC Relay Card is a component of the AMS 6500 ATG machine protection system. It is a freely programmable microprocessor-controlled module that can be used to do logical combination of binary signals within a AMS 6500 ATG system. When connected to an A6500-xR System Rack, the measurement cards provide and connect their logical outputs (COK, Alert, and Danger) automatically to the A6500-RC inputs through the backplane of the System Rack.

The A6500-RC captures the signals to logically combine them and provide the results through relay outputs. The A6500-RC is intended to be used in an A6500-xR System Rack (A6500-SR, A6500-RR, or A6500-FR) which is equipped with a separate slot for the A6500-RC.

The A6500-RC Relay Card is equipped with 66 digital, galvanically separated input channels (24 V logic), 16 output relays, one green system status LED and 16 yellow relay status LEDs on the monitor front to indicate the output relay statuses. All 66 input channels can be used separately and can thus be combined with each other individually. The 16 output relay channels are designed as single-pole switchover contacts (SPDT).

Connection of external digital signals is possible if using an A6500-RR system rack or an A6500-FR system rack. The A6500-RC card is not mandatory for the operation of an AMS 6500 ATG.

In conjunction with the A6500-CC Com Card status data of the A6500-RC can be provided through Modbus RTU, Modbus TCP/IP and OPC UA. As the Relay Card is designed for use with A6500-xR System Racks, generally a Com Card is required for configuration purposes.

3.2 Design

The A6500-RC Relay Card is designed as a double-standard Euro card (100 mm x 160 mm). The mechanical dimensions of the card match the dimensions of corresponding A6500-xR System Racks exactly. The front plate dimension of the A6500-RC is 3RU height and 10HP width. As the A6500-RC is manufactured in sandwich board design, the main board is equipped with a 96-pole terminal connector and the relay board is equipped with a 48-pole terminal connector (IEC 60603-2, F 48 M) to connect the respective backplane slot. [Figure 3-1](#) shows the side view of the Relay Card.

Figure 3-1: Side view

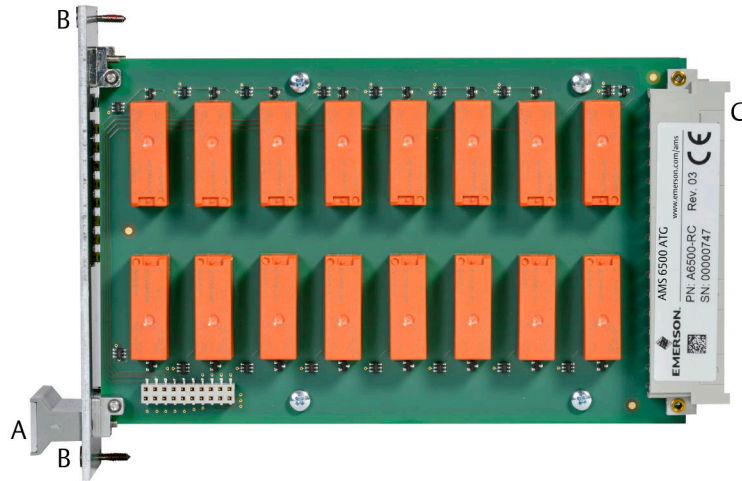

- A. Handle for pulling the monitor from the rack with a small sticker with the serial number on it.
- B. Mounting screws
- C. Connector with type plate with designation (PN), serial number (SN), and hardware revision (Rev.).

Figure 3-2 shows the front plate elements.

Figure 3-2: Front view

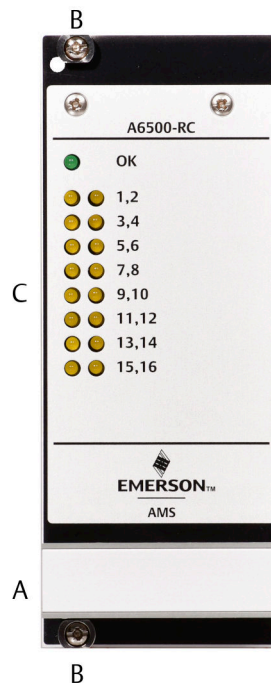

- A. Handle
- B. Mounting screws
- C. green LED: Supply voltage OK indication
orange LEDs: Status of the 16 relay outputs

4 Installation

For installation and mounting of the A6500-RC into an A6500-xR System Rack the relay output terminals and wiring are described in the operation manual of the A6500-xR System Racks. The Relay Card can be only installed in the double slot 12 (12.1 and 12.2) of the A6500-SR System Rack or in the double slots 10 (10.1 and 10.2) and 11 (11.1 and 11.2) of the A6500-RR System Rack.

Note

The AMS 6500-ATG cards are hot-swappable. So it is not necessary to switch off the power supply of the system rack for installing or replacing cards.

⚠ CAUTION

Any work at the system may impair machine protection.

Procedure

1. Wire the relay output contacts of the slot in accordance to the required application.
2. Push the A6500-RC into the prepared slot 12 (12.1 & 12.2).
The interconnections to the digital outputs of slots 1 to slot 11 are already done through the backplane.
3. Secure the card by gently fastening the screws at the front plate.

4.1 CSA - General safety

Conditions of acceptability

See chapter "CSA - General safety" of the A6500-xR System Racks operating manual (MHM-97877) for conditions of acceptability.

4.2 Commissioning

Procedure

1. If the card is not configured, create a configuration with the AMS Machine Studio software and download it to the card (see [Configuration](#)).
2. Ensure proper work by checking input and output signals (see [Functional check](#)).

5 Hazardous location installation

The ex-approval of the A6500-RC Relay Card is only valid if the Relay Card is installed in an A6500-xR System Rack. See chapter "Hazardous location installation" of the A6500-xR System Racks operating manual (MHM-97877) for details.

6 Configuration

6.1 General configuration procedure

The configuration can be performed offline, that means without connection to the card or online with a connection to the card. In any case, the configuration has to be loaded into the card. The A6500-CC Com Card is required for the configuration procedure. See Com Card operating manual for details.

Requirements:

- A6500-CC Com Card (only online configuration)
- A6500-RC Relay Card installed in an A6500-xR System Rack (only online configuration)
- Power supply (only online configuration)
- USB cable with Type-A and Type-B plug or Ethernet cable (only online configuration)
- AMS Machine Studio (configuration software)
- PC or laptop with Microsoft Windows 10

6.1.1 Offline configuration

Procedure

1. Start AMS Machine Studio.
2. Enter configuration parameter according to the task.
3. Save the configuration.

Later, load the configuration to the card when you can connect to the card.

Send a saved configuration file to the card

Procedure

1. Switch on the power supply of the system if not already on.
2. Connect the laptop to the Com Card of the system by using the USB or Ethernet connection.
3. Start AMS Machine Studio.
4. Select the Relay Card and click **Configure**.
5. Open the saved configuration file (window **File**, menu item **Open**).
6. Send the configuration to the card.
7. Close AMS Machine Studio and disconnect the connection to the Com Card.
After these steps, the Relay Card is ready for operation.

6.1.2 Online configuration

Procedure

1. Switch on the power supply of the system if not already on.
2. Connect the laptop to the Com Card of the system by using the UBS or Ethernet connection.
3. Start AMS Machine Studio.
4. Select the card to be configured and click **Configure**.
5. Enter the configuration parameters according to the measuring task.
6. Send the configuration to the card.
7. Save the configuration (if needed).
8. Close AMS Machine Studio and disconnect the connection to the Com Card.
After these steps, the card is ready for operation.

6.2 Start of an offline card configuration

Procedure

1. Select **Workspace** in the left part of the **Home** window then click **Item** (see [Figure 6-1](#)). A list with all available system devices opens.

Figure 6-1: Start new device configuration

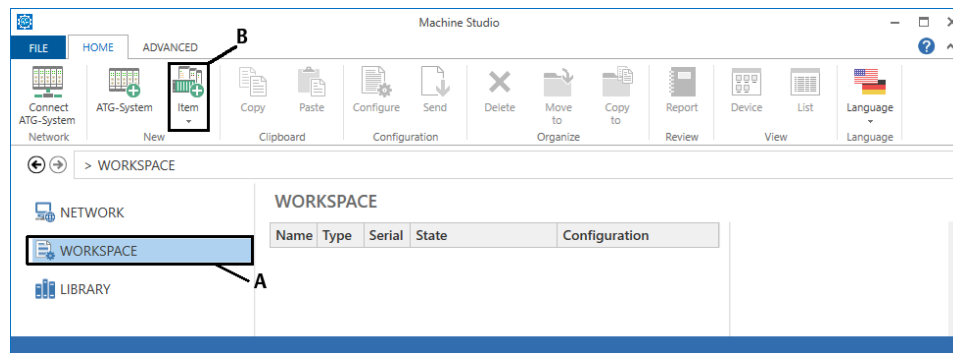

A. Workspace

B. Button Item

2. Select the A6500-RC card from the device list (see [Figure 6-2](#)).

Figure 6-2: Device selection

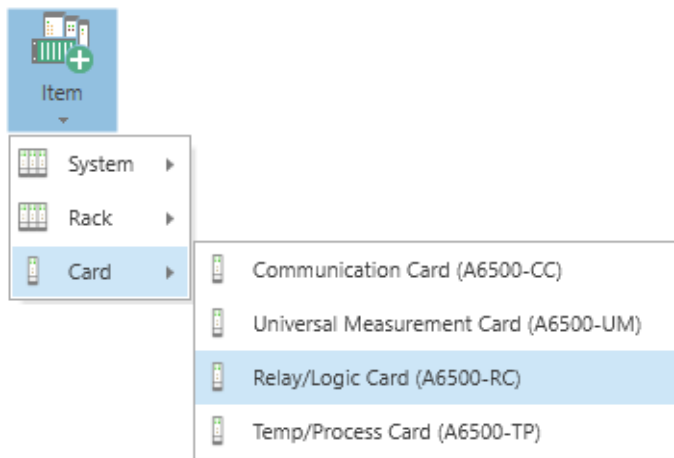

The Relay Card will be added to the list below **Workspace**.

3. Select **Relay/Logic Card (A6500-RC)** from the device list and click **Configure** (see [Figure 6-3](#)).

Figure 6-3: Open editor

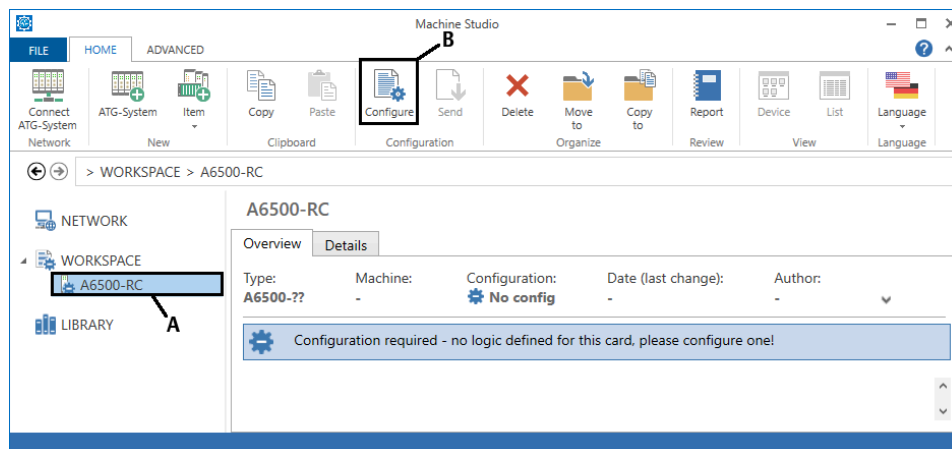

- A. New A6500-RC card.
- B. Button **Configure** to open the configuration editor.

The window for the selection of the measuring application opens.

4. Select an application.
 5. Click **Create Configuration** to open the configuration.
- See [Configuration editor and parameters](#) for parameter description and settings.

6.3 Start of an online card configuration

Procedure

1. Select the A6500-RC card from the **Network** list in the left part of the **Home** window, then click **Configure** (see Figure 6-4).

Figure 6-4: Select Relay Card for online configuration

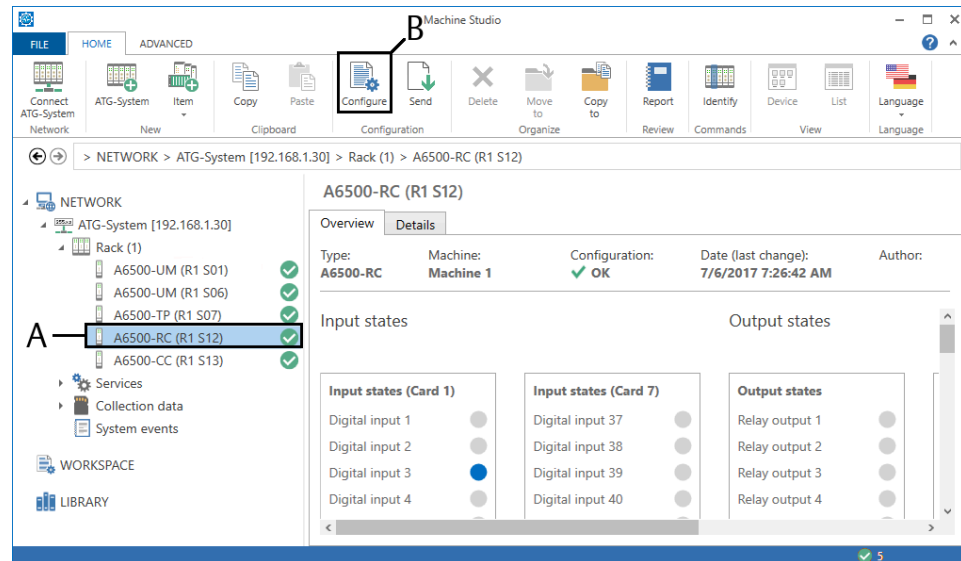

- A. Selected A6500-RC card.
- B. Button **Configure** for opening the configuration editor.

The window for selection of the measuring application opens if an unconfigured card has been selected, otherwise the editor with the configuration of the card directly opens.

2. Select an application. This step and the next step can be skipped if the editor has been directly opened.
3. Click **Create Configuration** to open the configuration.
See [Configuration editor and parameters](#) for parameter description and settings.

6.4 Configuration of an already existing card

Procedure

1. Select the card to be reconfigured from the **Network** list.
2. Click **Configure** to open the configuration window.
3. Make the changes to the configuration.
4. Send the configuration to the card (see [Send a configuration](#)).

6.5 Configuration editor and parameters

Figure 6-5 shows an overview of the general configuration editor Configuration.

Figure 6-5: Configuration editor

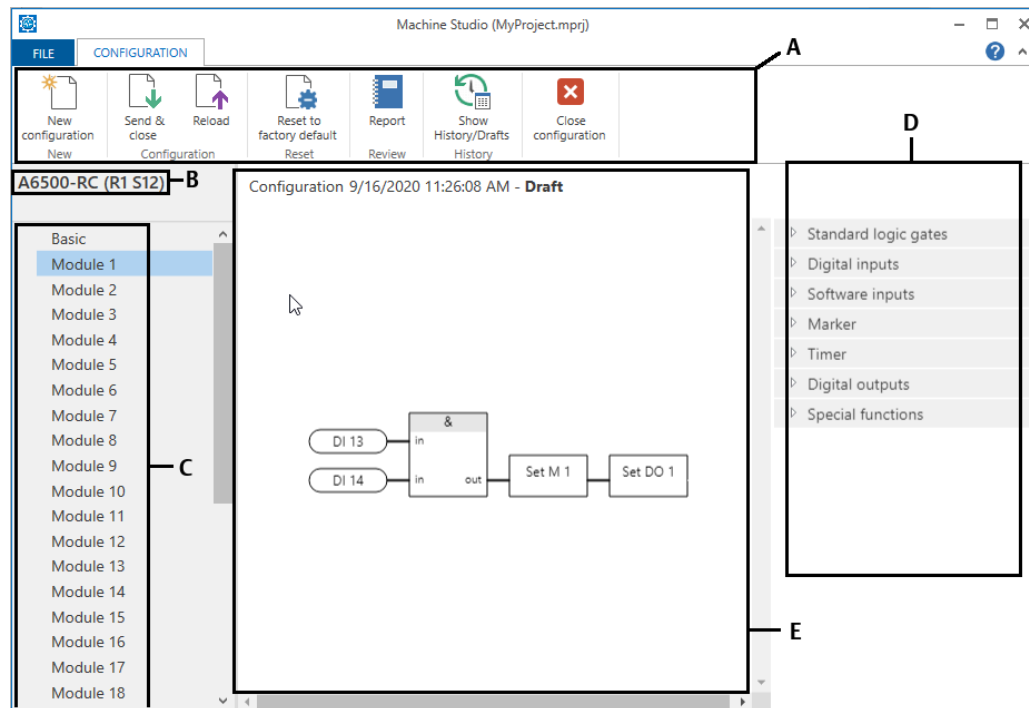

- A. Ribbon command bar
- B. Card name and position within the rack (only visible at connected racks, for example: R1 = Rack 1;S12 = Slot 12)
- C. List of configuration pages
- D. Elements for the logic configuration
- E. Configuration area

6.5.1 Ribbon command bar

New

Figure 6-6: Button "New"

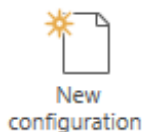

Click **New** to start a new configuration with default parameters.

Send & close

Figure 6-7: Button "Send & close"



Click **Send & close** to send the configuration to the Relay Card. The configuration editor automatically closes after the sending process. This command requires an online connection to the card. See [Send a configuration](#).

⚠ CAUTION

The machine protection function of the card is disabled during sending of configurations with major changes because of a reboot of the A6500-RC Card.

Reload

Figure 6-8: Button "Reload"



Click **Reload** to reload the configuration from the Relay Card to the configuration editor.

Reset to factory default

Figure 6-9: Button "Rest to factory default"

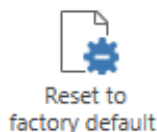

Click **Reset to factory default** to reset the connected Relay Card to the default parameter settings. After a successful reset the OK LED is flashing. Now the card is in the delivery state again. A reset card is marked with the "No configuration" sign in the Online View (see [Figure 6-10](#)).

Figure 6-10: No configuration sign



This command requires an online connection to the card.

⚠ CAUTION

The preset configuration on the card will be deleted and replaced by the default configuration.

Compare

Figure 6-11: Button "Compare"



Click **Compare** to show differences between the configuration on the card and in the memory of the used Laptop or PC.

Report

Figure 6-12: Button "Report"



Click **Report** to open the report viewer. This report shows all configured parameters and some additional information as, for example, serial number and user information. This report can be exported to different formats as PDF, XPS, and Microsoft Excel or printed.

The logos in the header of the report can be changed.

1. Close the configuration editor.
2. Click tab **File** and then **Settings**.
The window **Settings** opens (see [Figure 6-13](#)).
3. Click the buttons with the dotted line within the **Report settings** area to browse for logos.
Logos with file format "png" or "jpg" can be selected.
4. Click **OK** to confirm your settings.
5. Open the configuration editor and go back to the report.
Now the report contains the selected logos.

Figure 6-13: General settings

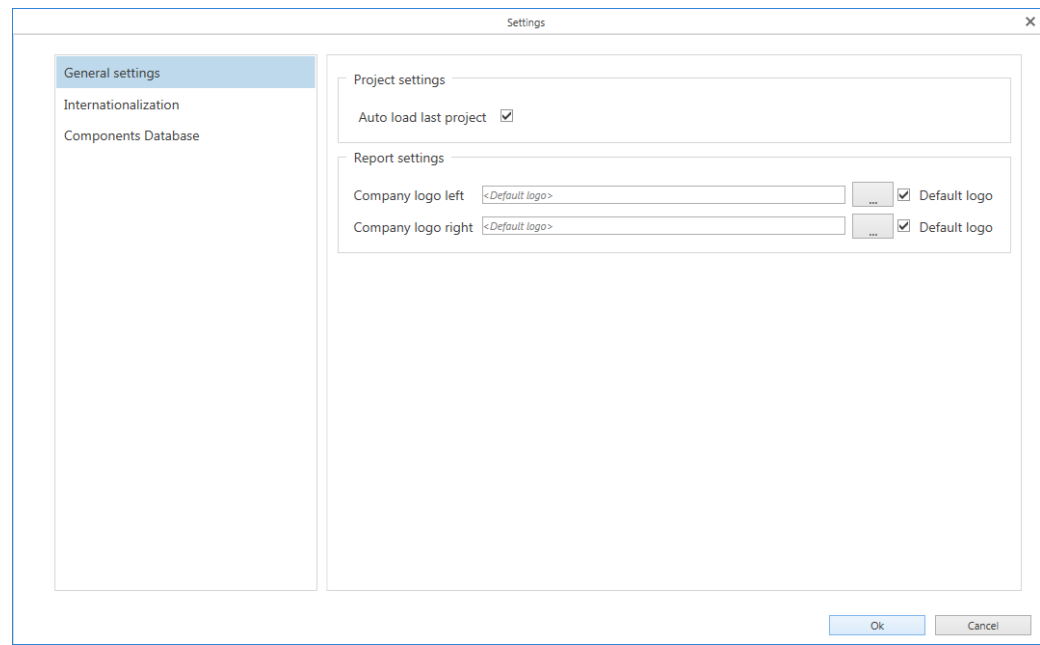

Show History/Drafts

Figure 6-14: Button "Shows History/Drafts"

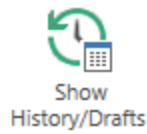

Click **Show History/Drafts** to open the History (see [Figure 6-15](#)).

Figure 6-15: History

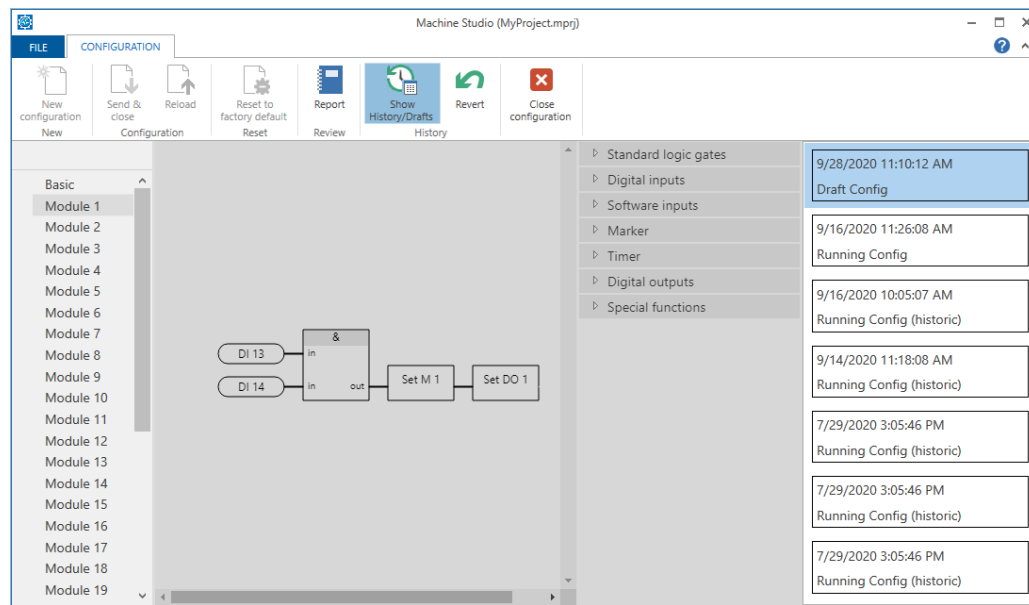

The right part of [Figure 6-15](#) lists the configuration history. The individual files are marked with date and time and type:

- **Draft Config**
A saved preliminary configuration file which has not yet send to the card.
- **Running Config**
This configuration file is running on the connected card.
- **Running Config (historic)**
An old configuration file which was running in the past.

The configuration area is grayed out. You can see the parameters of the draft or historic files but you can not change them here. To edit a draft or historic configuration:

1. Select a draft or historic file from the list.
The parameter of the selected file are displayed in the grayed out configuration area.
2. Click **Revert** (see [Figure 6-16](#)). The selected file is opened in the configuration area and the history window is closed. Click **Show History/Drafts** again, if you want to leave the history without any file copying.

Figure 6-16: Button "Revert"



Editor and Online

Figure 6-17: Button "Editor" and button "Online"

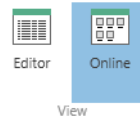

These buttons are available when a **Module** page is selected from the list of configuration pages. Use the **Editor** and **Online** buttons to toggle between the editor view and the online view. The button of the selected view is highlighted.

Editor In the editor view, configure logics as described in [Module 1 to Module 32](#).

Online In the online view, check the configured logics already stored in the A6500-RC. The online view requires an online connection to the A6500-RC card and no changes in any **Module**. To ensure that the shown configuration is the configuration stored in the A6500-RC card click **Reload** (see [Reload](#)).

Note

To check a changed **Module**, send the configuration with the changes to the A6500-RC before.

It is not possible to make any changes to the configuration in the online view except to **Basic**. Switch back to the editor view to change logics.

Simulate input signals to see if the created logic reacts as expected. How to simulate input signals is described in [Functional check](#).

Elements are colored based on their logic state:

- Elements that are logic **1** are colored red.
- Elements that are logic **0** are colored blue.
- Current timer values are colored green.

The logic state is also shown with **1** or **0** at the input and output of each element. See [Figure 6-18](#).

Figure 6-18: Logic in the online view

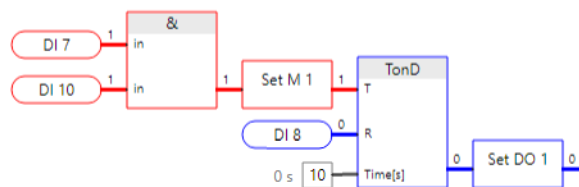

The online view requires a stable connection between AMS Machine Studio and the A6500-RC card, otherwise the logic values cannot be displayed. A disturbed connection is indicated with the note shown in [Figure 6-19](#).

Figure 6-19: Indication of an unstable connection

 Logic values could not be determined. Make sure your connection is stable!

In this case, check the connection to the A6500-RC card.

The logic is grayed out if the logic is changed by another AMS Machine Studio while the online view is open. This is indicated with the note shown in [Figure 6-20](#).

Figure 6-20: Indication of a changed logic

 Configuration has been changed. Use "Reload" to proceed with the latest configuration!

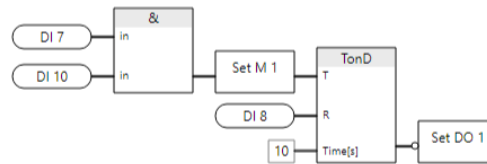

In this case, reload the configuration of the A6500-RC card. See [Reload](#).

Close configuration

Figure 6-21: Button "Close configuration"

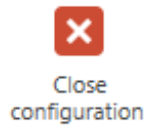

Click **Close configuration** to leave the configuration editor. Changes are automatically saved as a draft configuration. A saved draft can be opened in the history view.

6.5.2 Basic

Enter the basic settings of the configuration (see [Figure 6-22](#)).

Figure 6-22: Basic

The screenshot shows the configuration interface for an A6500-RC (R1 S12) card. The title bar indicates the configuration is a draft from 9/16/2020 10:05:07 AM. The left sidebar lists modules from 1 to 14, with 'Basic' selected. The main area contains the following fields:

- Card name:** An empty text input field.
- Machine:** An empty text input field.
- Area:** An empty text input field.
- Plant:** An empty text input field.
- User:** An empty text input field.
- Date (last change):** A text field containing '9/16/2020 10:05:07 AM'.
- Configuration version:** A text field containing '2.90.21.9692'.
- Enable marker events:** A checkbox that is currently unchecked.

Card name	Enter the card name or a short description of the task.
Machine	Enter the machine designation.
Area	Enter a name or a short description of the area where the machine is located.
Plant	Enter the plant/factory name.
User	The name of the user who made the last configuration is displayed . The user name of the login data of the operation system is used for this automatic entry. It is not possible to change the content of this field.
Date (last change)	The date and time of the last card configuration is displayed. Time and date of the configuration PC is used. It is not possible to change the content of this field.
Configuration version	The version of AMS Machine Studio used to configure the card is displayed.
Enable marker events	Place a checkmark in the box to add events caused by markers to the event list. The amount of events caused by markers depends on the configuration of the Relay Card and can be enormous.

Note

The A6500-RC card is able to process 32 events per second. If more than 32 events per second occur, events can get lost. In this case, an error message is issued.

6.5.3 Module 1 to Module 32

The configuration pages **Module 1** to **Module 32** are identical in functionality and identical in configuration. Use these pages to configure the different logics to individually control the output relays.

Figure 6-23: Module 1 to Module 32

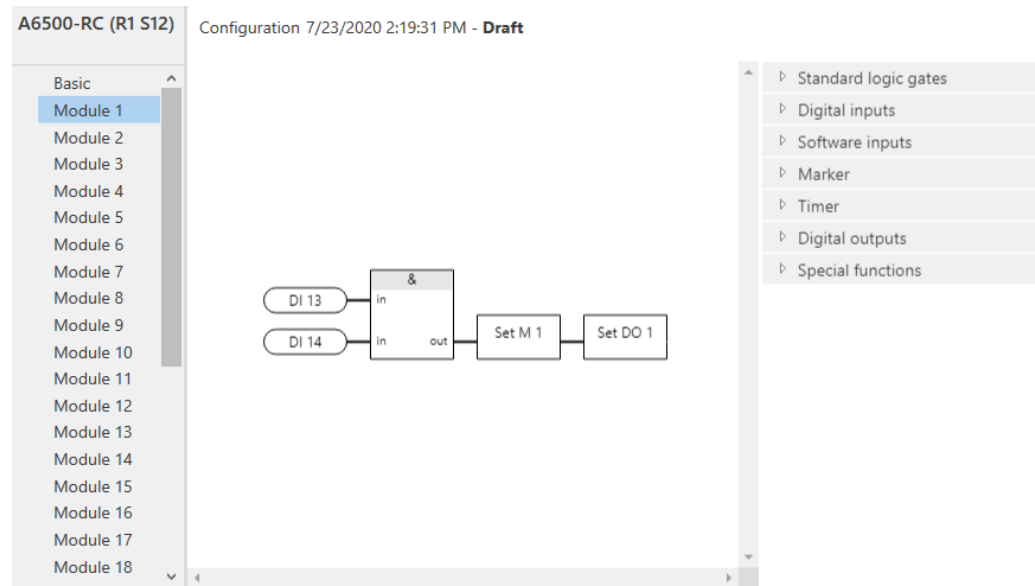

Different elements are available for each module to build up the logics. These elements are listed at the top right of the **Configuration** window and can be shown in detail by clicking on the arrow down symbol in front of each element group (see [Figure 6-24](#)).

Figure 6-24: Elements



Note

All elements can be placed within the configuration window by drag and drop. Logic elements that are configured incorrectly are marked red.

Observe the following limitations for a logic configuration:

- Maximum of 32 logic modules
- Maximum of 20 gates for each module
- Maximum of 8 gates, digital outputs, or markers in a row for each module
- Maximum of 256 gates
- Maximum of 32 inputs for each gate
- Maximum of 32 timers

Standard logic gates

For definition of a logic, choose one logic gate from the element list **Standard Logic Gates** and place it within the configuration area per drag & drop. See [Table 6-1](#) for the function of the different logic gates. Each gate offers the opportunity to connect further modules to the output.

Table 6-1: Standard logic gates

Logic gate	Description
	<p>AND</p> <p>The output is 1 if all inputs are logical 1 otherwise the output is 0.</p>
	<p>OR</p> <p>The output is 1 if at least one of the inputs is logical 1 otherwise the output is 0.</p>
	<p>XOR</p> <p>The output is 1 if an uneven number of inputs is logical 1 otherwise the output is 0.</p>
	<p>RS-Latch; S (set) has priority</p> <p>There are two inputs: S (set) and R (reset) . A logical 1 at input S sets the output to 1. A logical 1 at input R sets the output to 0. A logical 1 at both inputs sets the output to 1.</p>
	<p>SR-Latch; R (reset) has priority</p> <p>There are two inputs: S (set) and R (reset). A logical 1 at input S sets the output to 1. A logical 1 at input R sets the output to 0. A logical 1 at both inputs sets the output to 0.</p>
	<p>Negative Edge Detector</p> <p>A transition from a logical 1 to a logical 0 sets the output to 1. 1 is set for only one process cycle.</p>
	<p>Positive Edge Detector</p> <p>A transition from a logical 0 to a logical 1 sets the output to 1. 1 is set for only one process cycle.</p>

Table 6-1: Standard logic gates (continued)

Logic gate	Description
	<p>M out of N voting The logic gate contains N inputs. If $\geq M$ out of N inputs are logical 1 the output is 1 otherwise 0.</p>

See [Figure 6-25](#) how to place the first logic gate.

Figure 6-25: Place the first logic gate

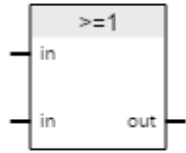
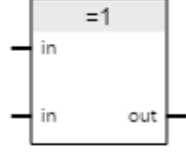
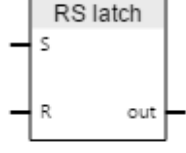
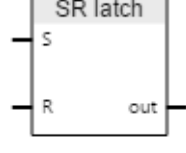
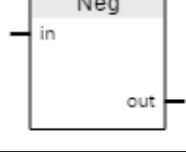
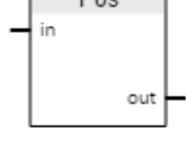
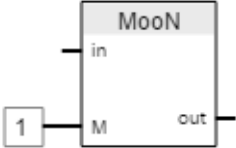
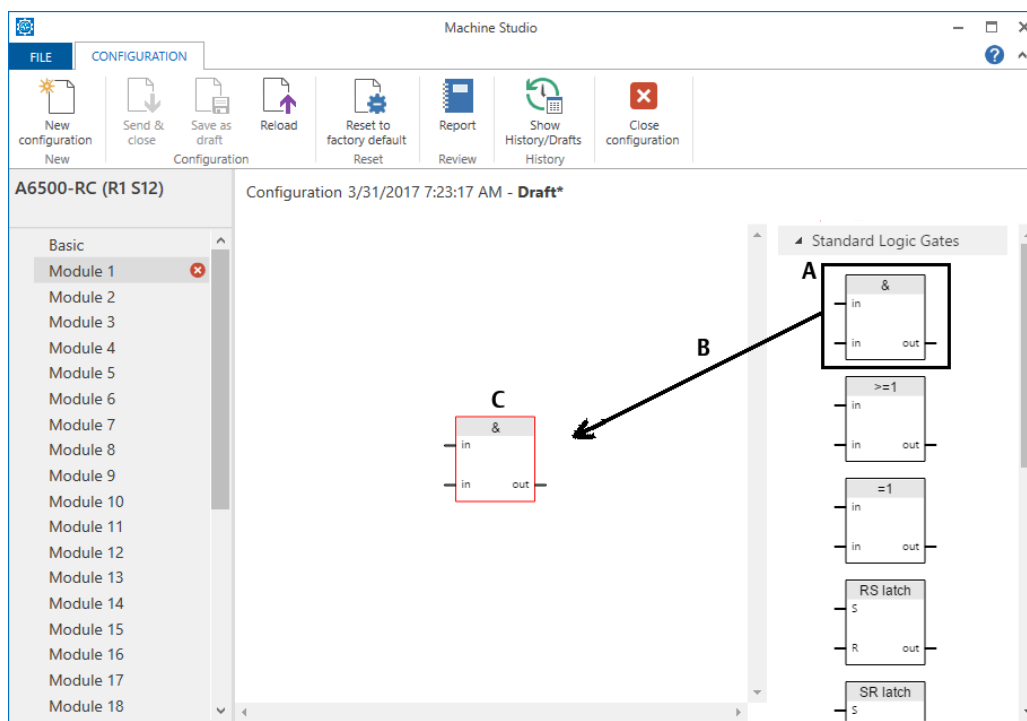

1. Click and hold a logic gate (A, [Figure 6-25](#)).
2. Move the selected gate into the configuration area (B, [Figure 6-25](#)).
3. Release the mouse button to place the gate into the area (C, [Figure 6-25](#)).

The first logic gate is red colored until an input has been added. The respective module is marked with a red circle with a white x. The **Send & close** button is grayed out as long as the configuration is not OK.

All further logic gates are added as shown in [Figure 6-26](#).

Figure 6-26: Add a logic gate

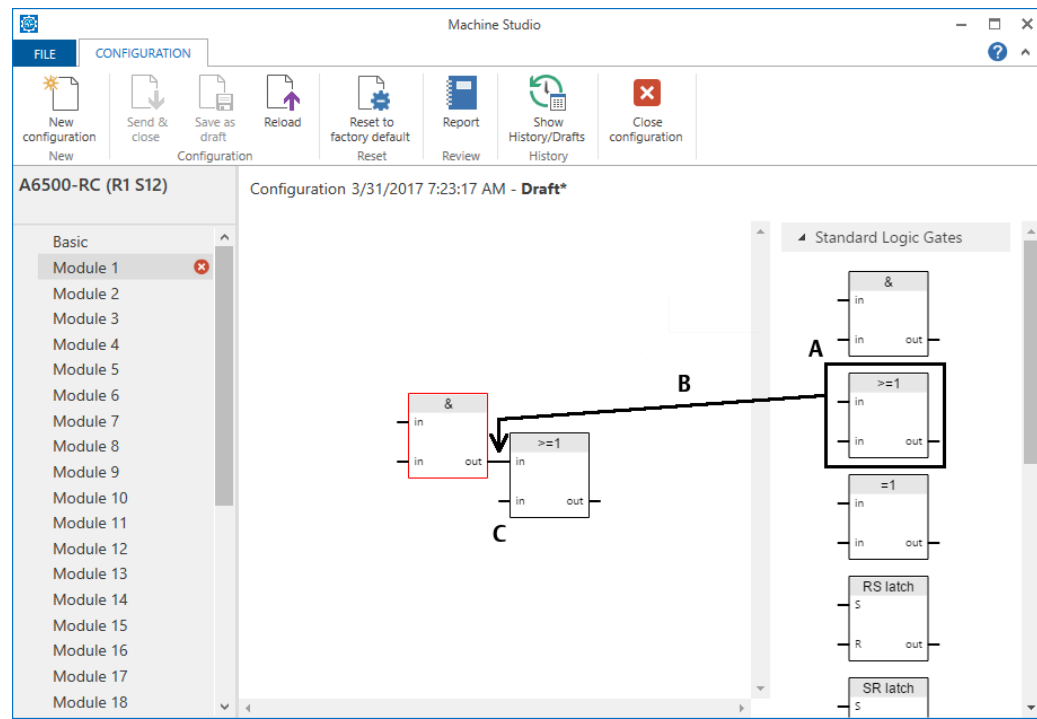

1. Click and hold a logic gate (A, [Figure 6-26](#)).
2. Move the selected gate into the configuration area (B, [Figure 6-26](#)).
The selected gate can be connected either to an input or an output of an already placed logic gate.
3. Place the selected gate so that the output and the input to be connected are blue framed (see [Figure 6-27](#)).

Figure 6-27: Connection of logic gates

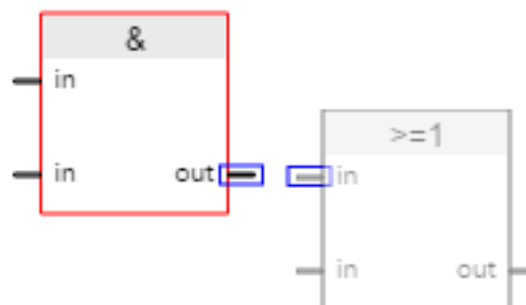

4. Release the mouse button to connect the selected gate (C, [Figure 6-26](#)).

Note

Not connected gate inputs are ignored in the logic.

To delete a logic gate, click it with the left mouse button. The frame becomes blue and a delete icon appears (see Figure 6-28). Click the icon or press the delete key to remove the logic gate.

Figure 6-28: Delete a logic gate

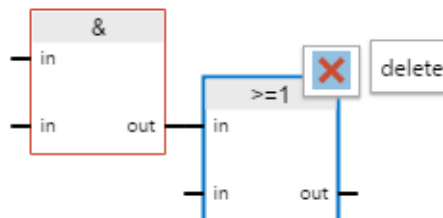

Note

If the logic gate has more than one connected input, all connected inputs are deleted.

If you do not want to delete the gate, click somewhere on the configuration area to reset the selection of the logic gate.

Digital inputs

This list contains all 66 digital inputs (DIN) of the Relay Card. The digital outputs (DOUT) of A6500-UM Universal Measurement Cards and A6500-TP Temperature Process Cards installed in an A6500-xR System Rack are assigned to these digital inputs (see Table 6-2).

Table 6-2: Assignment of digital outputs to Relay Card inputs

Slot	Digital output	Input Relay Card	Slot	Digital output	Input Relay Card	Slot	Digital output	Input Relay Card
1	DOUT1	DIN01	4	DOUT5	DIN23	8	DOUT3	DIN45
	DOUT2	DIN02		DOUT6	DIN24		DOUT4	DIN46
	DOUT3	DIN03	5	DOUT1	DIN25	9	DOUT5	DIN47
	DOUT4	DIN04		DOUT2	DIN26		DOUT6	DIN48
	DOUT5	DIN05		DOUT3	DIN27		DOUT1	DIN49
	DOUT6	DIN06		DOUT4	DIN28		DOUT2	DIN50
2	DOUT1	DIN07	6	DOUT5	DIN29	10	DOUT3	DIN51
	DOUT2	DIN08		DOUT6	DIN30		DOUT4	DIN52
	DOUT3	DIN09	6	DOUT1	DIN31	10	DOUT5	DIN53
	DOUT4	DIN10		DOUT2	DIN32		DOUT6	DIN54
	DOUT5	DIN11		DOUT3	DIN33		DOUT1	DIN55 ¹
	DOUT6	DIN12		DOUT4	DIN34		DOUT2	DIN56 ¹
3	DOUT1	DIN13		DOUT5	DIN35		DOUT3	DIN57 ¹

Table 6-2: Assignment of digital outputs to Relay Card inputs (continued)

Slot	Digital output	Input Relay Card	Slot	Digital output	Input Relay Card	Slot	Digital output	Input Relay Card
	DOUT2	DIN14	7	DOUT6	DIN36	11	DOUT4	DIN58 ¹
	DOUT3	DIN15		DOUT1	DIN37		DOUT5	DIN59 ¹
	DOUT4	DIN16		DOUT2	DIN38		DOUT6	DIN60 ¹
	DOUT5	DIN17		DOUT3	DIN39		DOUT1	DIN61 ²
	DOUT6	DIN18		DOUT4	DIN40		DOUT2	DN62 ²
4	DOUT1	DIN19	8	DOUT5	DIN41		DOUT3	DIN63 ²
	DOUT2	DIN20		DOUT6	DIN42		DOUT4	DIN64 ²
	DOUT3	DIN21		DOUT1	DIN43		DOUT5	DIN65 ²
	DOUT4	DIN22		DOUT2	DIN44		DOUT6	DIN66 ²

¹ External inputs A6500-FR and A6500-RR

² External inputs A6500-RR

See [Figure 6-29](#) how to add digital inputs.

Figure 6-29: Add a digital input

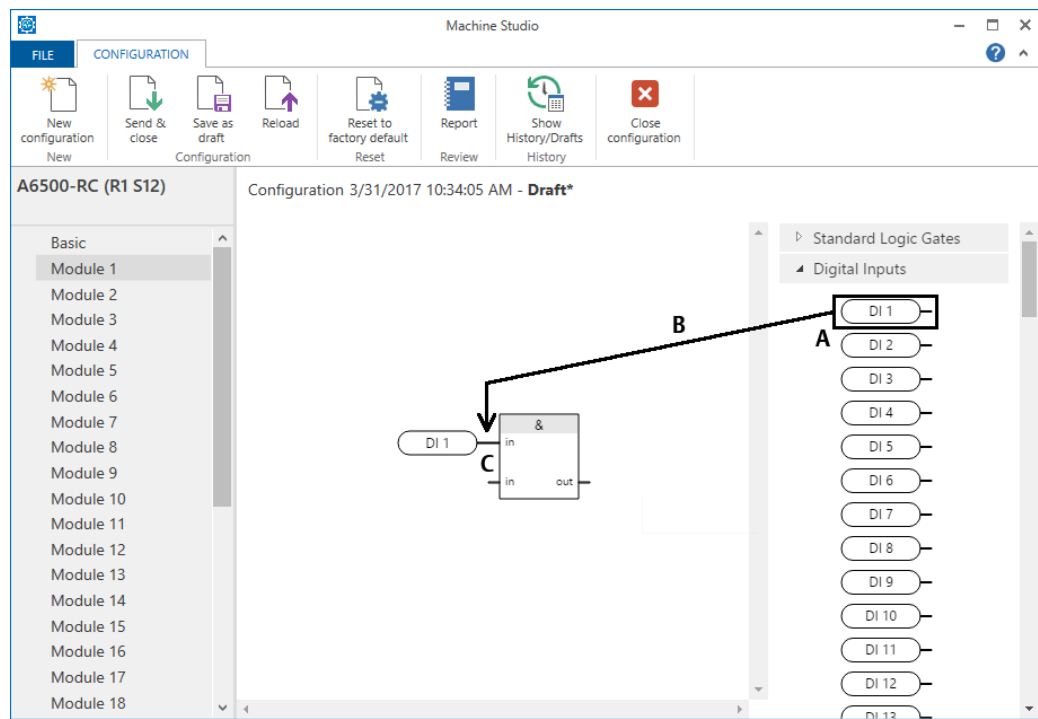

1. Click and hold a digital input (A, [Figure 6-29](#)).
2. Move the selected digital input into the configuration area (B, [Figure 6-29](#)).

The selected input can be connected to available inputs of a logic gate. If all visible inputs are occupied, add a new input to the logic gate (32 inputs at maximum).

- Place the selected input so that the connection point of the input and the input of the logic gate are blue framed (see [Figure 6-27](#)).

Figure 6-30: Connection of a digital input

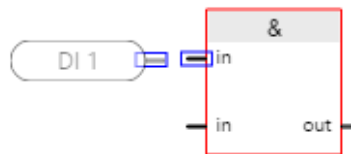

If all visible inputs are occupied, move the digital input into the logic gate. The logic gate is blue framed and the note **add** appears (see [Figure 6-31](#)).

Figure 6-31: Add a new port for a digital input

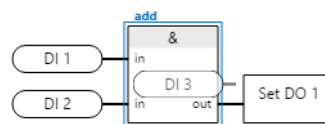

- Release the mouse button (C, [Figure 6-29](#)).
The input is added to the logic gate. The inputs are connected to the logic gate in the same sequence as they are added.

To negate an input, click on the input line (see [Figure 6-32](#)). Click it again to remove the negation.

Figure 6-32: Negate an input

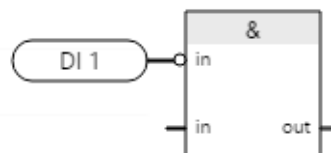

Left click the digital input to open the properties. The frame becomes blue and some icons appear (see [Figure 6-33](#)).

- Icon **Rename**
Click **Rename** to rename the digital input. An entry field for the new designation appears. The maximum text length is 20 characters.
- Icon **Delete**
Click **Delete** to remove the digital input from the logic gate.

Figure 6-33: Properties - digital input

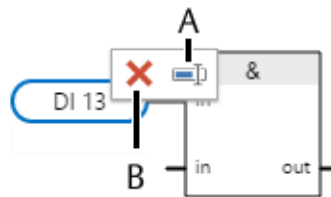

- A. *Rename icon*
- B. *Delete icon*

If you do not want to make any changes, click somewhere on the configuration area to reset the selection of the digital input.

Software inputs

Up to 16 software inputs can be used to build up logics. Use the Modbus or OPC UA interface to change the logic state of the software inputs.

Up to five Modbus TCP or OPC UA clients or the Modbus RTU interface can be used to change the logic state of the software inputs. Independently of which client sends the command, the last command received changes the logic state.

The typical reaction time for a software input is approximately one second. The reaction time is the time between sending the command and the recognition of the command by the Relay Card. At a high input load, the reaction time might be higher.

Note

The software inputs are set to their default state (Off) if the A6500-CC Com Card reboots or the Modbus service or the OPC service is re-configured.

See [Figure 6-34](#) how to add software inputs.

Figure 6-34: Add a software input

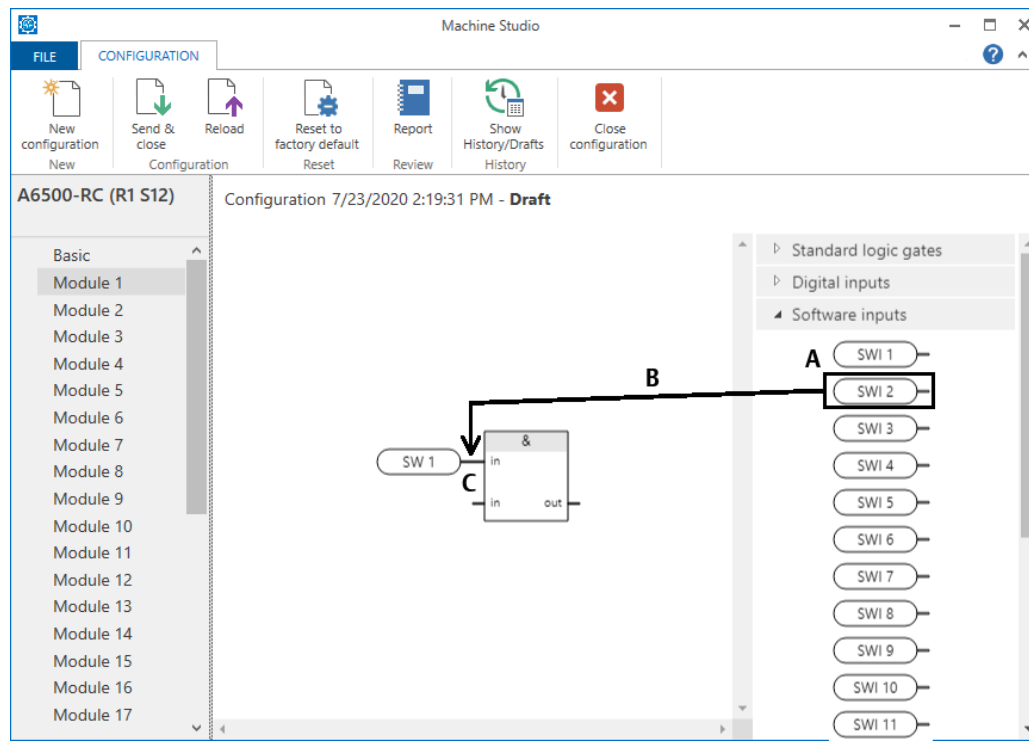

1. Click and hold a software input (A, [Figure 6-34](#)).
2. Move the selected software input into the configuration area (B, [Figure 6-34](#)).
The selected input can be connected to available inputs of a logic gate. If all visible inputs are occupied, add a new input to the logic gate (32 inputs at maximum).
3. Place the selected input so that the connection point of the input and the input of the logic gate are blue framed (see [Figure 6-35](#)).

Figure 6-35: Connection of a software input



If all visible inputs are occupied, move the software input into the logic gate. The logic gate is blue framed and the note **Add** appears (see [Figure 6-36](#)).

Figure 6-36: Add a new port for a software input

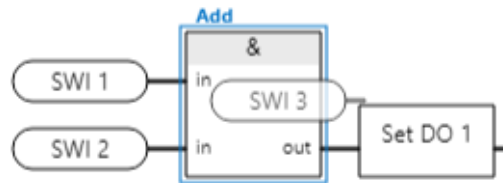

4. Release the mouse button.
The input is added to the logic gate. The inputs are connected to the logic gate in the same sequence as they are added.

To negate an input, click on the input line (see [Figure 6-37](#)). Click it again to remove the negation.

Figure 6-37: Negate an input

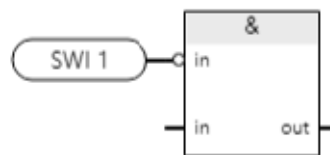

Left click the software input to open the properties. The frame becomes blue and some icons appear (see [Figure 6-38](#)).

- Icon **Rename**
Click **Rename** to rename the digital input. An entry field for the new designation appears. The maximum text length is 20 characters.
- Icon **Delete**
Click **Delete** to remove the digital input from the logic gate.

Figure 6-38: Properties – software input

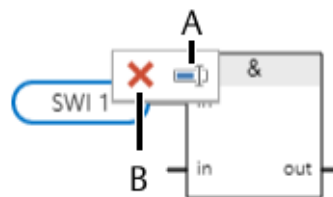

- A. *Rename icon*
- B. *Delete icon*

If you do not want to make any changes, click somewhere on the configuration area to reset the selection of the software input.

Replace an input

Each input can be replaced by another input without deleting the prior input.

1. Select an input from the available elements. This can be a digital input, a software input, a marker, or a digital output.
2. Click and hold an input.
3. Move the selected input over the input to be replaced.
The input is framed in blue and the note **Replace** appears (see Figure 6-39).

Figure 6-39: Replace an input



4. Release the mouse button.
The existing input is replaced by the new one.

Marker

The markers list contains 64 markers. Use markers, for example, to combine interim results of logic gates with other logic gates. See Figure 6-40 how to connect a marker to a logic gate output.

Figure 6-40: Add a marker to a logic gate output

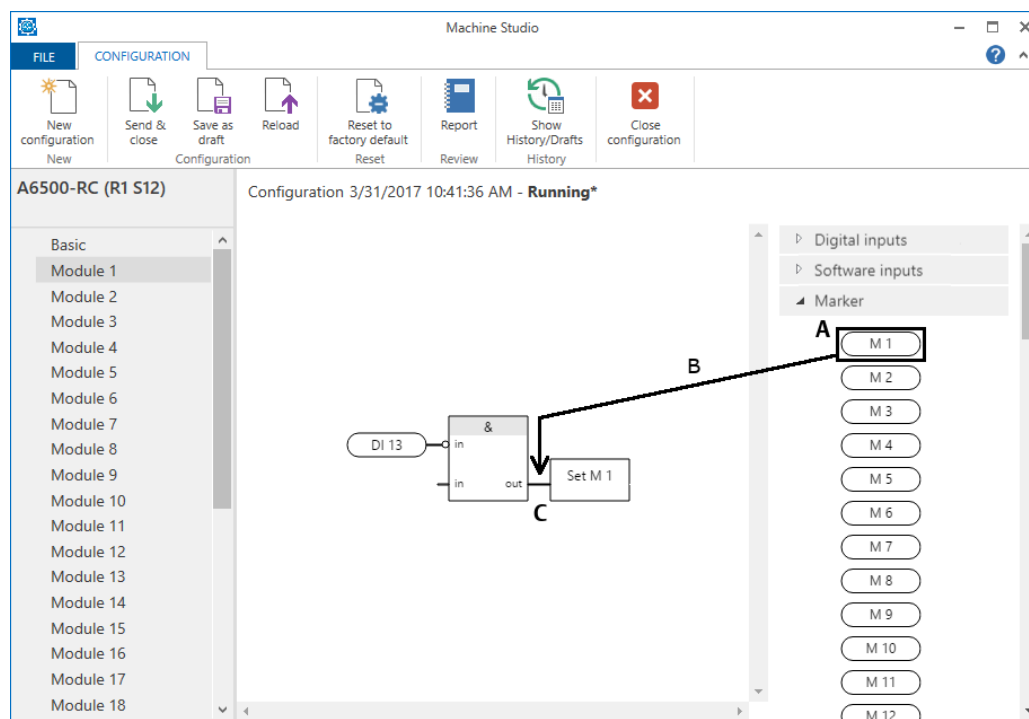

1. Click and hold a marker (A, [Figure 6-40](#)).
2. Move the selected marker close to the output of a logic gate (B, [Figure 6-40](#)). Place the selected marker so that the connection point of the marker and the output of the logic gate are blue framed (see [Figure 6-41](#)).

Figure 6-41: Connection of a marker to an output

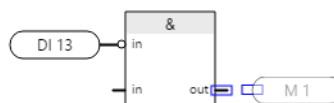

3. Release the mouse button to connect the selected marker to the logic gate (C, [Figure 6-40](#)). The marker is added to the output of the logic gate.

To delete a marker, click it with the left mouse button. The frame becomes blue and a delete icon appears (see [Figure 6-42](#)). Click the icon or press the delete key to remove the marker from the output of the logic gate.

Figure 6-42: Delete a marker



If you do not want to delete the marker, click somewhere on the configuration area to reset the selection of the marker.

See [Figure 6-43](#) how to add a marker as a digital input.

Figure 6-43: Add a marker as a digital input

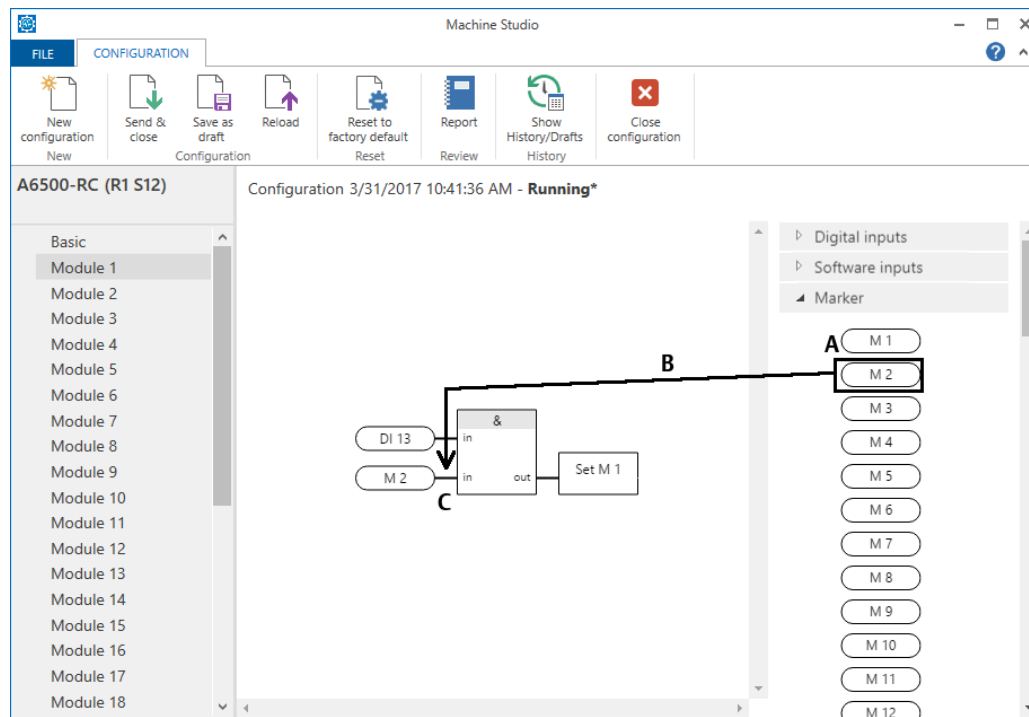

1. Click and hold a marker (A, [Figure 6-43](#)).
2. Move the selected marker close to the input of the logic gate where to add it (B, [Figure 6-43](#)).
Place the selected marker so that the connection point of the marker and the input of the logic gate are blue framed (see [Figure 6-44](#)).

Figure 6-44: Connection of a marker to an input

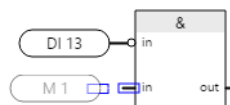

If all visible inputs are occupied, add a new input to the logic gate (32 inputs at maximum).

Move the marker into the logic gate. The logic gate is blue framed and the note **add** appears (see [Figure 6-45](#)).

Figure 6-45: Add a new port for a marker

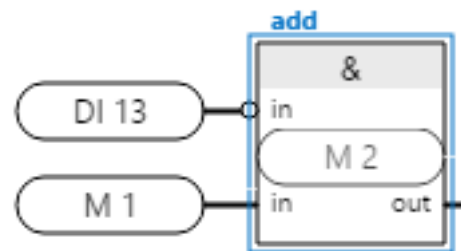

3. Release the mouse button (C, [Figure 6-43](#)).
The marker is added to the logic gate. The markers are connected to the logic gate in the same sequence as they are added.

To negate a marker input, click the input line (see [Figure 6-46](#)). Click it again to remove the negation.

Figure 6-46: Negate a marker input



Left click a marker to open the properties. The frame becomes blue and some icons appear (see [Figure 6-47](#)).

- Icon **Rename**
Click **Rename** to rename the marker as input. An entry field for the new designation appears. The maximum text length is 20 characters. If the same marker is used several times in one logic configuration, the name is automatically changed at all locations.
- Icon **Delete**
Click **Delete** to remove the marker from the logic gate.

Figure 6-47: Properties - marker as input

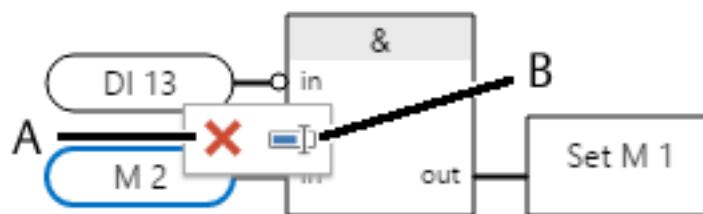

- Delete icon*
- Rename icon*

If you do not want to make any changes, click somewhere on the configuration area to reset the selection of the marker.

Timer

This list contains different timers (see [Table 6-3](#)). Use the timers to add, for example, turn-on delays to logical gate outputs.

Table 6-3: Timer

Timer	Description
 <p>The diagram shows a rectangular block labeled 'ToFFD'. It has three input ports on the left: 'T' (top), 'R' (middle), and 'Time[s]' (bottom). A small box containing the number '1' is connected to the 'Time[s]' input. On the right side, there is an output port labeled 'out'.</p>	<p>Timer off Delay (switch off delay)</p> <p>This timer has a trigger input (T), a reset input (R) and a configurable switch off delay time (Time[s]). The timer starts to elapse from the configured time at a transition from logical 1 to 0 at the trigger input (T) and runs as long as the trigger input is logical 0. If the timer expires the output is set to 0. The output is logical 1 if the trigger input is logical 1 and as long as the timer runs. The reset input (R) has priority. If the reset input is logical 1 the output is always 0.</p> <ul style="list-style-type: none"> • The output is logical 1 when the trigger input (T) is logical 1 and the reset input (R) is logical 0. • The output is logical 0 when the reset input (R) is logical 1. • The output is logical 1 when the trigger input (T) is logical 0 and the timer elapse, but has not expired and the reset input (R) is logical 0.
 <p>The diagram shows a rectangular block labeled 'TonD'. It has three input ports on the left: 'T' (top), 'R' (middle), and 'Time[s]' (bottom). A small box containing the number '1' is connected to the 'Time[s]' input. On the right side, there is an output port labeled 'out'.</p>	<p>Timer on delay (switch on delay)</p> <p>This timer has a trigger input (T), a reset input (R) and a configurable switch on delay time (Time[s]). The timer starts to elapse from the configured time at a transition from logical 0 to 1 at the input (T) and runs as long as the input (T) is 1. If the timer expires the output is set to 1 until the logical input is reset to 0. The reset input (R) has priority. If the reset input (R) is logical 1 the output is always 0.</p> <ul style="list-style-type: none"> • The output is logical 0 when the trigger input (T) is logical 0. • The output is logical 0 when the reset input (R) is logical 1. • The output is logical 1 when the trigger input (T) is logical 1, the timer is expired, and the reset input (R) is logical 0.
 <p>The diagram shows a rectangular block labeled 'TI'. It has three input ports on the left: 'T' (top), 'R' (middle), and 'Time[s]' (bottom). A small box containing the number '1' is connected to the 'Time[s]' input. On the right side, there is an output port labeled 'out'.</p>	<p>Timer Impulse</p> <p>This timer has a trigger input (T), a reset input (R) and a configurable impulse time (Time[s]). The time starts to elapse from the configured time at a transition from logical 0 to 1 at the trigger input. The output is set to 0 when either the timer expires or the trigger input is logical 0. The output is reset to 0 as long the reset input is logical 1. The startup state of the output is 0.</p> <ul style="list-style-type: none"> • The output is logical 0 when the trigger input (T) is logical 0. • The output is logical 0 when the reset input (R) is logical 1. • The output is logical 1 when the trigger input (T) is logical 1 and the timer elapse, but has not expired and the reset input (R) is logical 0.

Table 6-3: Timer (continued)

Timer	Description
	<p>Timer Enlarged Impulse</p> <p>This timer has a trigger input (T), a reset input (R), and a configurable impulse time (Time[s]). At a transition from logical 0 to 1 at the trigger input (T) the output is set to logical 1 and the time starts to elapse from the configured time. If the timers expires the output is set to 0. The output is logical 0 as long as the reset input (R) is logical 1.</p>

See [Figure 6-48](#) how to connect a timer to a logic gate output.

Figure 6-48: Add a timer to a logic gate

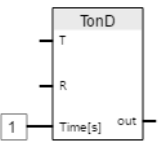
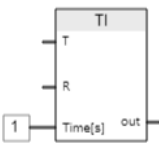
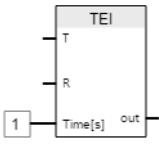
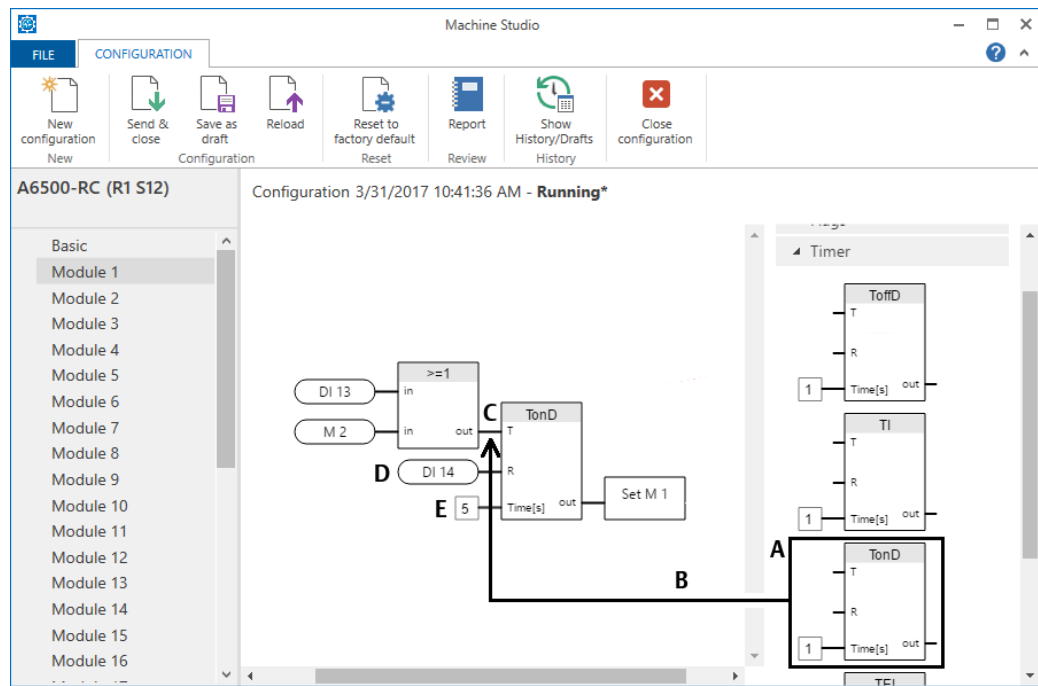

1. Click and hold a timer (A, [Figure 6-48](#)).
2. Connect the selected timer either to an input or to an output of a logic gate. Move the timer close to the connection of the logic gate where to add it (B, [Figure 6-48](#)). To connect the timer to an output of a logic gate, place the timer so that the trigger input of the timer (T) and the output of the logic gate are blue framed (see [Figure 6-49](#)).

Figure 6-49: Connection of a timer to an output of logic gate

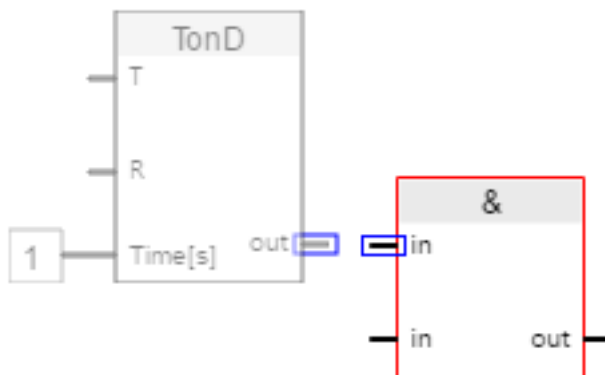

To connect the timer to an input of a logic gate, place the timer so that the output of the timer (out) and the input of the logic gate are blue framed (see [Figure 6-50](#)).

Figure 6-50: Connection of a timer to an input of a logic gate

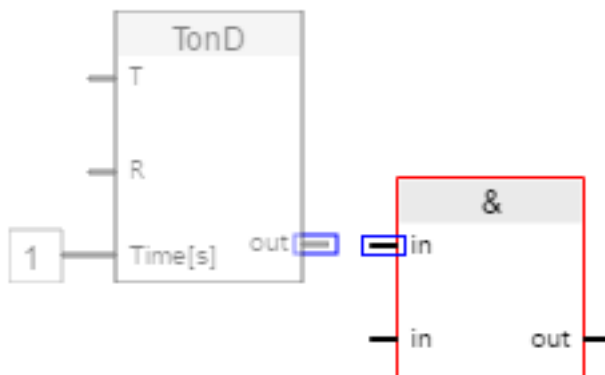

3. Release the mouse button to connect timer to the logic gate output (C, [Figure 6-48](#)).
4. Add a digital input, a marker, or another logical gate to the reset input (R) of the timer (D, [Figure 6-48](#)).
5. Click on the input field of the timer (Timer[s]) and enter a delay or impulse time. The maximum time is 1000 seconds (E, [Figure 6-48](#)).

To negate an input click on the respective input line (see [Figure 6-51](#)). Both inputs, the trigger input (T) and the reset input (R) can be negated. Click them again to remove the negation.

Figure 6-51: Negate timer inputs

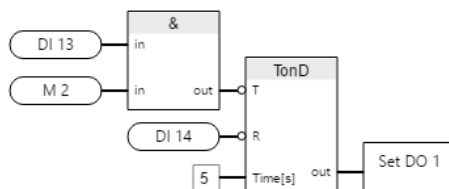

To delete a timer, click it with the left mouse button. The frame becomes blue and a delete icon appears (see [Figure 6-52](#)). Click the icon or press the delete key to remove the timer.

Figure 6-52: Delete a timer

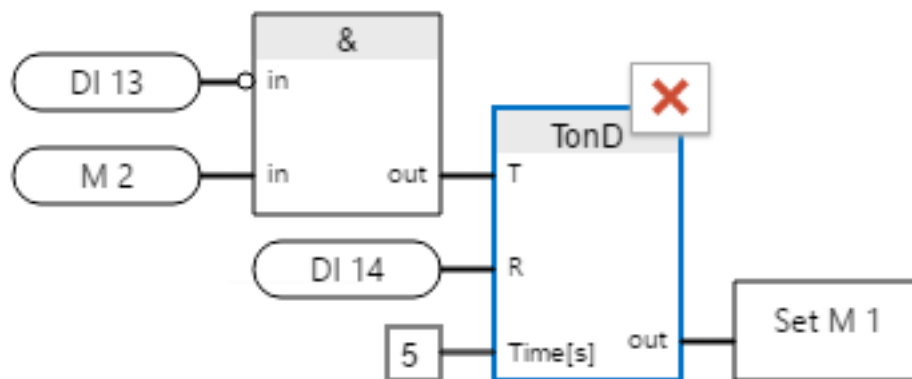

Note

If the timer has more than one connected input, all connected inputs are deleted.

If you do not want to delete the timer, click somewhere on the configuration area to reset the selection of the timer.

Digital outputs

The A6500-RC Relay Card is equipped with 16 output relays. These relays are controlled by digital outputs listed below **Digital outputs**. See [Figure 6-53](#) to connect a digital output to an output.

Figure 6-53: Add a digital output

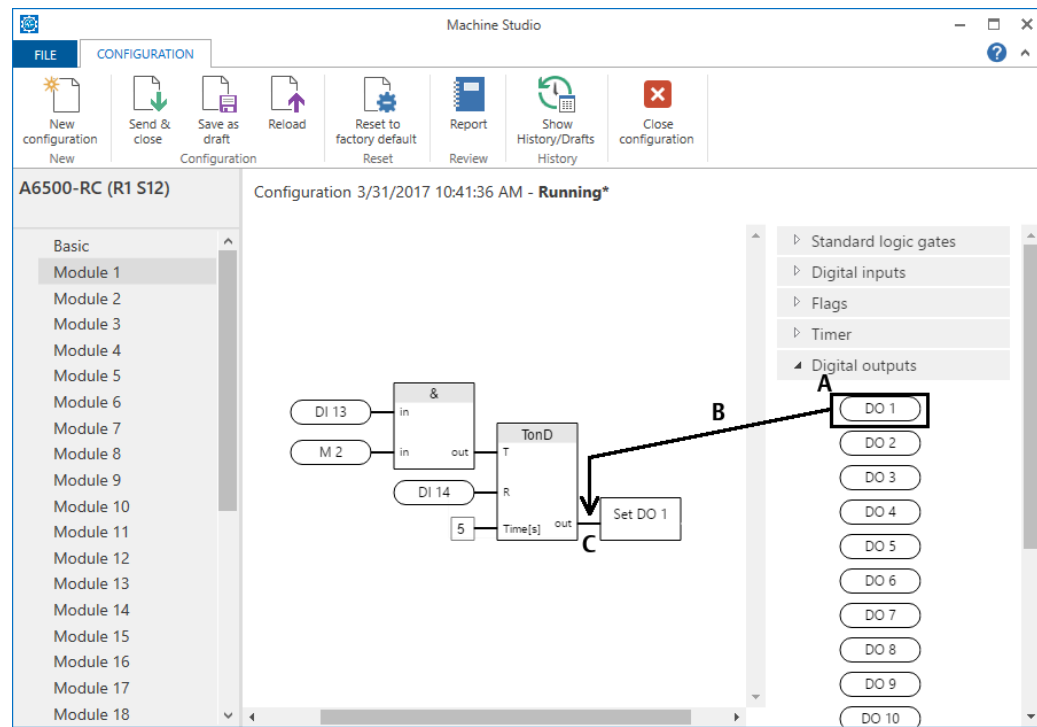

1. Click and hold a digital output (A, [Figure 6-53](#)).
2. Move the selected digital output close to the output of a logic gate or timer (B, [Figure 6-53](#)).
Place the selected output so that the connection point of the digital output and the output of the logic gate or timer are blue framed (see [Figure 6-54](#)).

Figure 6-54: Connection of a digital output to an output

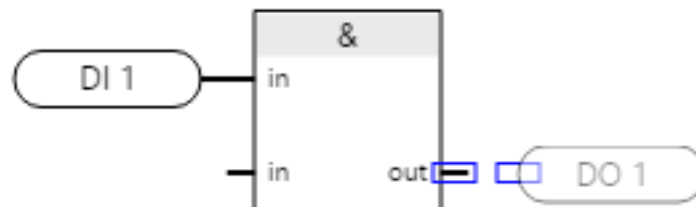

3. Release the mouse button to connect the selected digital output to the output (C, [Figure 6-53](#)).
The digital output is connected to the output of the logic gate or timer.

To delete a digital output, click it with the left mouse button. The frame becomes blue and a delete icon appears (see [Figure 6-55](#)). Click the icon or press the delete key to remove the digital output from the output of the logic gate or timer.

Figure 6-55: Properties – digital output

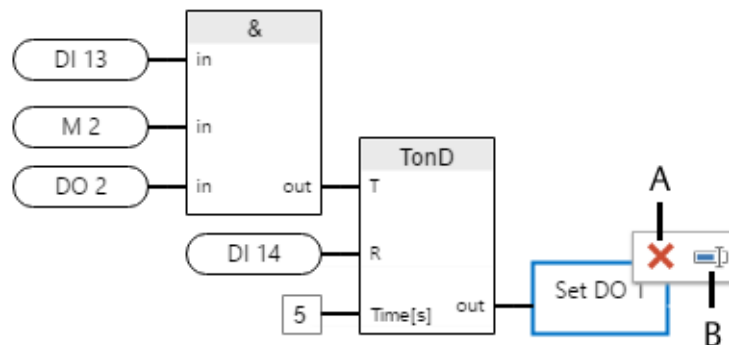

- A. Delete icon
- B. Rename icon

If you do not want to delete the digital output, click somewhere on the configuration area to reset the selection of the digital output.

To rename the digital output, click it with the left mouse button. The frame becomes blue and a rename icon appears (see [Figure 6-55](#)). Click the rename icon to rename the digital output. An entry field for the new designation appears. The maximum text length is 20 characters.

If you do not want to rename the digital output, click somewhere on the configuration area to reset the selection of the digital output.

See [Figure 6-56](#) how to add a digital output as an input.

Figure 6-56: Add a digital output as a digital input

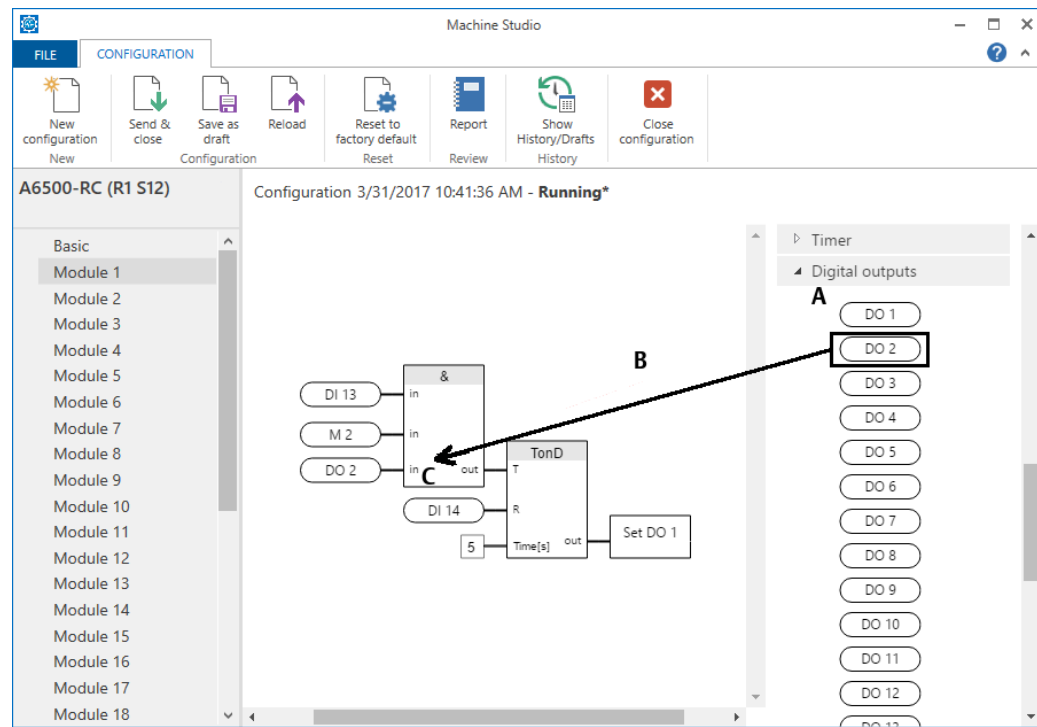

1. Click and hold a digital output (A, [Figure 6-56](#)).
2. Move the selected digital output close to the input of a logic gate or timer where to add it (B, [Figure 6-56](#)).

Place the digital output so that the connection point of the digital output and the input of the logic gate or timer are blue framed (see [Figure 6-44](#)).

Figure 6-57: Connection of a digital output to an input

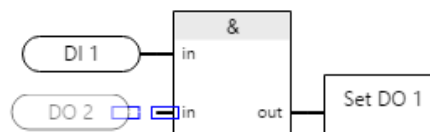

If all visible inputs of an logic gate are occupied, add a new input (32 inputs at maximum).

Move the digital output into the logic gate. The logic gate is blue framed and the note **add** appears (see [Figure 6-45](#)).

Figure 6-58: Add a new port for a digital output

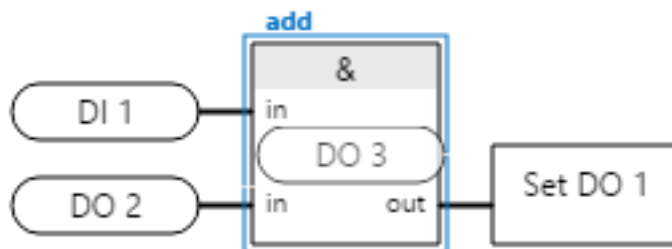

3. Release the mouse button to connect the selected digital output to the input (C, [Figure 6-56](#)).
The digital output is connected to the input of the logic gate or timer.

To negate an input click on the respective input line (see [Figure 6-59](#)). Click it again to remove the negation.

Figure 6-59: Negate a digital output

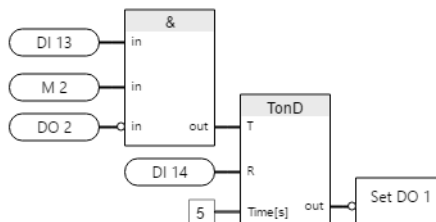

Left click a digital output to open the properties. The frame becomes blue and some icons appear (see [Figure 6-60](#)).

- **Icon Rename**
Click **Rename** to rename the digital output as input. An entry field appears for the new designation appears. The maximum text length is 20 characters. If the same digital output is used several times in one logic configuration, the name is automatically changed at all locations.
- **Icon Delete**
Click **Delete** to remove the digital output.

Figure 6-60: Pop-up menu – digital output as input

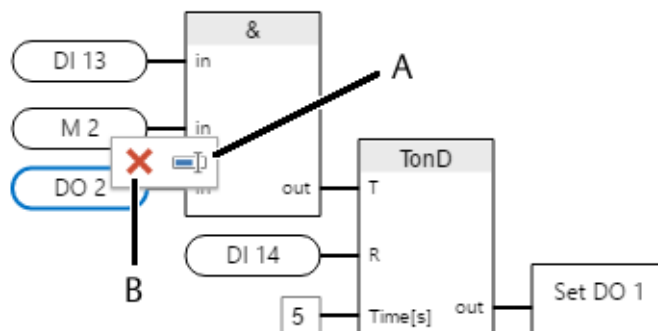

- A. Rename icon
- B. Delete icon

If you do not want to make any changes, click somewhere on the configuration area to reset the selection of the digital output.

Special functions

Table 6-4 lists the available functions.

Table 6-4: Special functions

Function	Description
Not connected	Always logic 0.
Timer 10 s	Cyclic on/off switching every 10 seconds.
Timer 1 s	Cyclic on/off switching every 1 seconds.
Timer 0.5 s	Cyclic on/off switching every 0.5 seconds.
Timer 0.1 s	Cyclic on/off switching every 0.1 seconds.
Startup	Only logic 1 during the first process cycle after startup, otherwise logic 0.
Temperature Alarm	Logic 1 at temperature danger alarm of the Relay Card, otherwise logic 0.
Communication Error	Logic 1 if a the communication between Relay Card and Com Card is disturbed, otherwise logic 0.
Logic 0	Always logic 0.
Logic 1	Always logic 1.

See [Figure 6-61](#) how to add a special function.

Figure 6-61: Add a special function

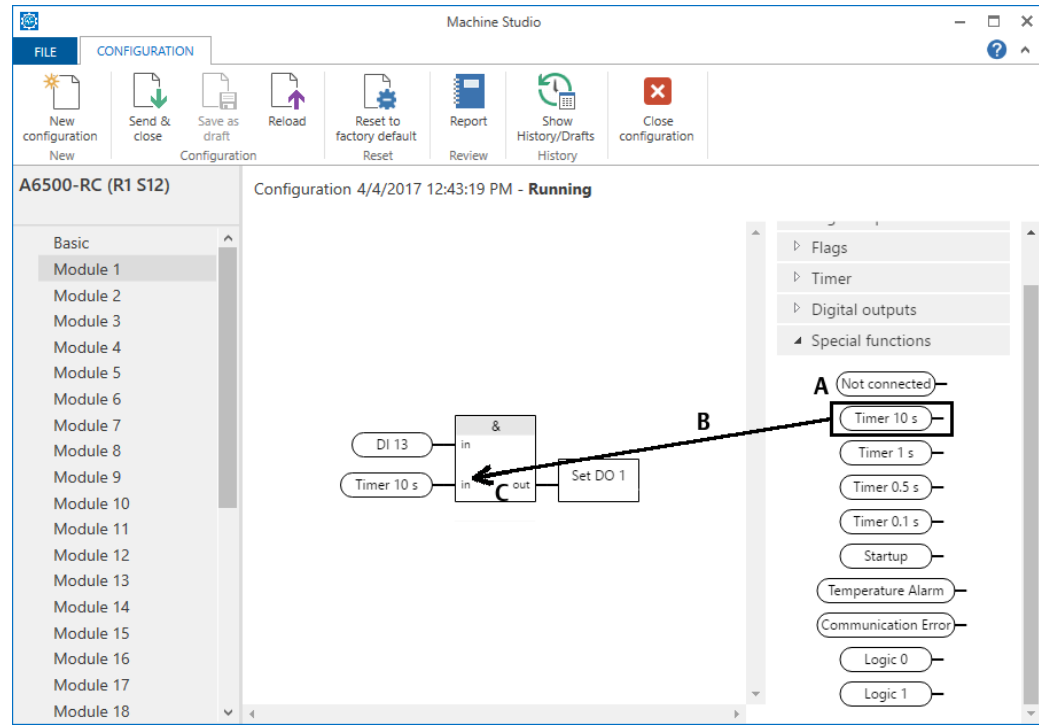

1. Click and hold a special function (A, [Figure 6-61](#)).
2. Move the selected special function close to the input of a logic gate or timer where to add it (B, [Figure 6-61](#)).
Place the special function so that the connection point of the special function and the input of the logic gate or the timer are blue framed (see [Figure 6-44](#)).

Figure 6-62: Connection of a special function to an input

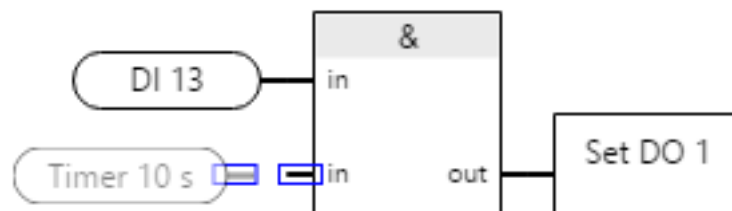

If all visible inputs of an logic gate are occupied, add a new input (32 inputs at maximum).

Move the special function into the logic gate. The logic gate is blue framed and the note **add** appears (see [Figure 6-45](#)).

Figure 6-63: Add a new port for a special function

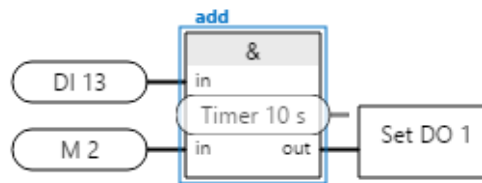

3. Release the mouse button to connect the special function to the input (C, [Figure 6-61](#)).

The special function is connected to the input of the logic gate or the timer.

To negate a special function click on the respective input line (see [Figure 6-64](#)). Click it again to remove the negation.

Figure 6-64: Negate a special function



To delete a special function, click it with the left mouse button. The frame becomes blue and a delete icon appears (see [Figure 6-65](#)). Click the icon or press the delete key to remove the special function from the input of a logic gate or timer.

Figure 6-65: Delete a special function

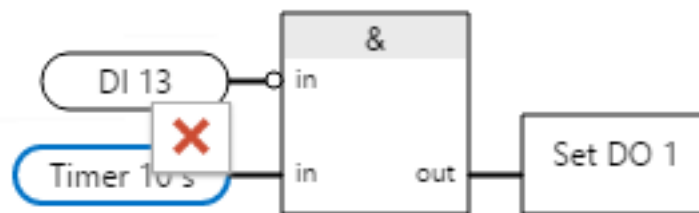

6.6 Send and reload a configuration

6.6.1 Send a configuration

⚠ CAUTION

The machine protection function of the card is disabled during sending of configurations with major changes because of a reboot of the A6500-RC Card.

Note

Modbus requests are answered with **Server Device Busy (0x06)** when sending a configuration.

Whether or not a reboot is required will depend on the changes to the configuration. The changes of names or text field entries do not require a reboot of the card.

Procedure

1. Ensure that there is an online connection between the A6500-RC Card and AMS Machine Studio running on a PC or laptop.
AMS Machine Studio will automatically establish an online connection to the cards of the AMS 6500 ATG system as soon as there is a physical connection through the USB port of the A6500-CC Com Card of the system. At TCP/IP connection, click **Connect ATG** on the Home ribbon to establish a connection.
2. Click **Send & close** in the ribbon command bar to send the configuration to the card.

A confirmation dialog opens in accordance to the boot requirement:

Figure 6-66: Confirmation – overwrite configuration without reboot

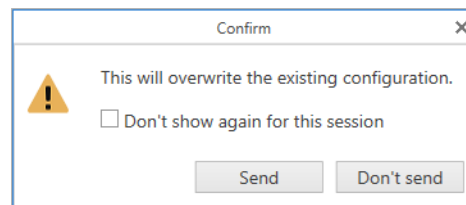

Click **Send** to overwrite the existing configuration without reboot.

Figure 6-67: Confirmation – overwrite configuration and reboot required

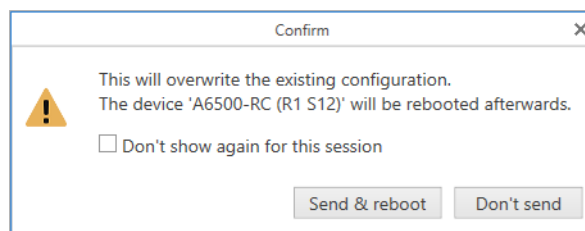

Click **Send & reboot** to overwrite the existing configuration and to reboot the A6500-RC Card afterwards. The machine protection function of the card is disabled during the process.

The configuration editor automatically closes afterwards.

A successful sent configuration will be indicated by a message in the upper right corner of the window. This message automatically disappears. Otherwise, close it by clicking on the cross.

The Modbus registers are automatically updated according to the sent configuration unless the AMS 6500 ATG is not protected by a password. The

successful update is also indicated by a message in the upper right corner (see [Figure 3](#)).

Figure 6-68: Modbus synchronization

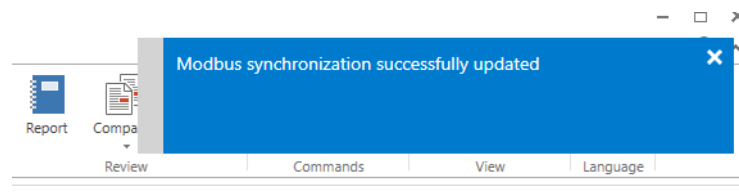

The card is ready to use when the "OK" LED on the card front shows a green steady light.

6.6.2 Reload a configuration

Once an online connection has been established, the configuration of all cards of a AMS 6500 ATG system are automatically loaded to AMS Machine Studio. Click **Reload** in the Home ribbon if the configuration of the card must be loaded again.

7 Online View

After connection to an A6500-xR System Rack the Online View of the connected rack appears on the main page of AMS Machine Studio. [Figure 7-1](#) shows this view.

Figure 7-1: Overview Online View

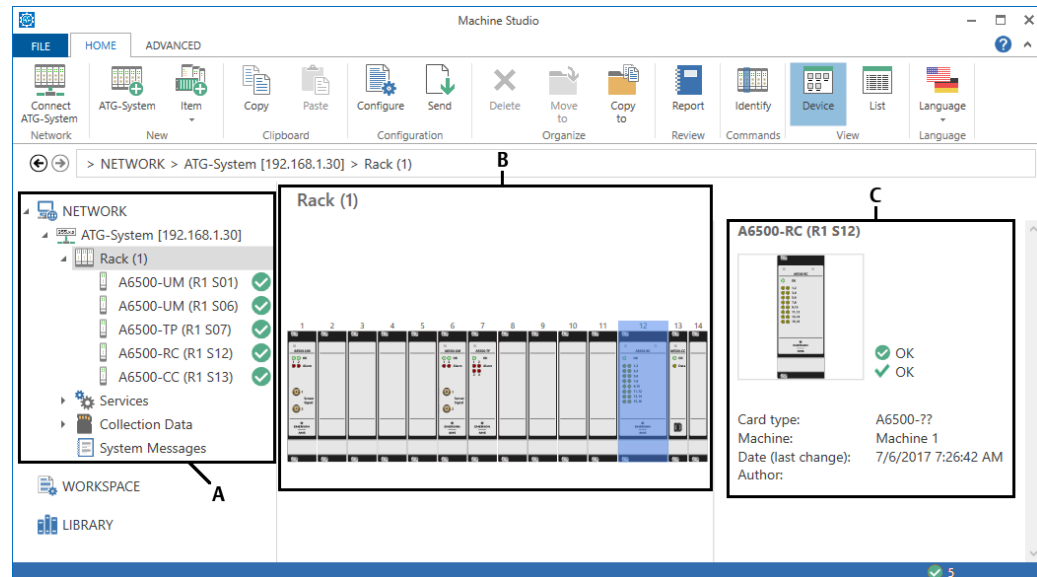

- A. Connected devices.
- B. Main window with rack view.
- C. A few details of the card selected from the rack overview.

Click on the A6500-RC card in the device tree or double click on a A6500-RC card shown in the rack view to open the Online View of the card. The Online View has two pages: **Overview** and **Details**. Each Online View page displays the machine name, plant name, area, serial number, module type, firmware version, date of last change to the configuration, and the author of the last configuration. There are two small additional icons, "Not in sync" and "No configuration". These icons appears on the card symbol in the **Network** list if the card is not in sync or has no configuration.

Not in sync

Figure 7-2: Not in sync



A Relay Card not in sync is marked with the symbol shown in [Figure 7-2](#). A Relay Card is "not in sync" if there is a draft configuration that has been not yet send to the card. For example, a logic gate of an A6500-RC cards has been changed and this change has been saved as draft.

1. Click the Relay Card not in sync in the listed of connected devices below **Network** to select the card. The row will be colored blue.
2. Click **Configure** in the ribbon command bar to open the editor.
3. Check the configuration.
4. Click **Send & close** to synchronize the card.
The configuration of the Relay Card is sent. The "not in sync" sign disappears after successful sending of the configuration.

No configuration

Figure 7-3: No configuration



A Relay Card without a configuration is marked with the symbol shown in [Figure 7-3](#). This card state is also indicated by slowly alternate flashing of the green OK LED on the front plate.

Note



The information and data on these pages are helpful for finding the cause of an unexpected behavior of the card.

7.1

Overview

[Figure 7-4](#) shows the **Overview** page.

Table 7-1: Card health temperature flag

Icon	Meaning	Action
	No over temperature	---
	The temperature, measured by the internal temperature sensor has exceeded the alert limit of 70°C.	Take appropriate measures to reduce the environmental temperature.
	The temperature, measured by the internal temperature sensor has exceeded the shut down limit of 80°C.	We recommend to replace the card as parts might be stressed or damaged because of the high temperature. Take appropriate measures to reduce the environmental temperature.

7.2 Details

Figure 7-5 shows the **Details** page. Some graphic objects are already described, see [Overview](#)). The graphic objects not yet described are described.

Figure 7-5: Details

A6500-RC (R1 S12)

Overview Details

Card: ATG-RC Machine: - Configuration: ✔ OK Date (last change): 4/19/2016 3:37:08 PM Author: ▼

Card

Card health

Temperature ✔

A

Service

Up time	1.7 d	Cold starts	9	Curr. temp.	29.5 °C
Operation time	21.5 d	Configured	9	Min. temp.	21.5 °C
				Max. temp.	35.5 °C

Input states:

Input states (Card 1)

Digital input 1 ● Digital input 4 ●

Digital input 2 ● Digital input 5 ●

Digital input 3 ● Digital input 6 ●

Input states (Card 2)

Digital input 7 ● Digital input 10 ●

Digital input 8 ● Digital input 11 ●

Digital input 9 ● Digital input 12 ●

A. Service data

Service data

This graphical object contains some statistical values and temperature information.

- **Up time**
Days in operation since the last power on. This counter is reset at each power on.
- **Operation time**
Days in operation since the first power on.
- **Cold starts**
This counter indicates the number of times the card has been powered on.
- **Configured**
This counter indicates the number of times the card has been successfully sent a configuration.
- **Curr. temp.**
The current temperature, measured by the card internal temperature sensor.
- **Min. temp.**
The minimum measured temperature.
- **Max. temp.**
The maximum measured temperature.

7.3 Online commands

The A6500-RC card related commands are described. For description of all other buttons of the ribbon command bar see operating manual "AMS Machine Studio - General Functions" (MHM-97879). [Figure 7-6](#) shows the available command buttons.

Figure 7-6: Command buttons

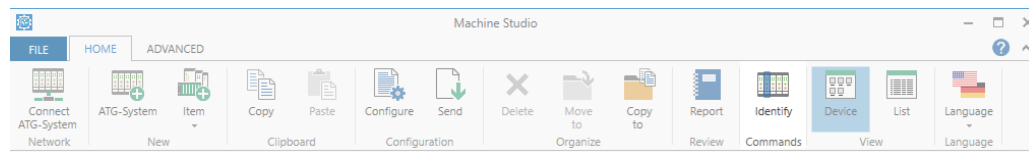

Note

Ensure that there is an online connection to the card before using these commands.

Identify

Figure 7-7: Button Identify



Click **Identify** to identify the card within the rack. This command starts a LED sequence on the front plate of the card. It runs for approximately 15 seconds and stops automatically afterwards.

8 Functional check and maintenance

8.1 Functional check

⚠ CAUTION

Any work at the system may impair machine protection.

Check the A6500-RC Relay Card and its logic configuration by simulating the digital input signals. Check the configured logic results by checking the LED statuses at the A6500-RC front plate or checking the respective output relay statuses.

8.1.1 Simulation by using a F48 extension card

Use a F48 extension card with wire bridges to simulate the digital output signals of A6500-UM or A6500-TP cards. These output signals are connected through the A6500-xR System Rack to the digital inputs of the A6500-RC Relay Card. An extension card consists of an F48 plug for installing in a slot with a F48 connector, a wire switch board and a F48 connector for connecting cards with F48 plugs. [Figure 8-1](#) shows the F48 plug and the wire switch board of an extension card.

Figure 8-1: F48 extension card

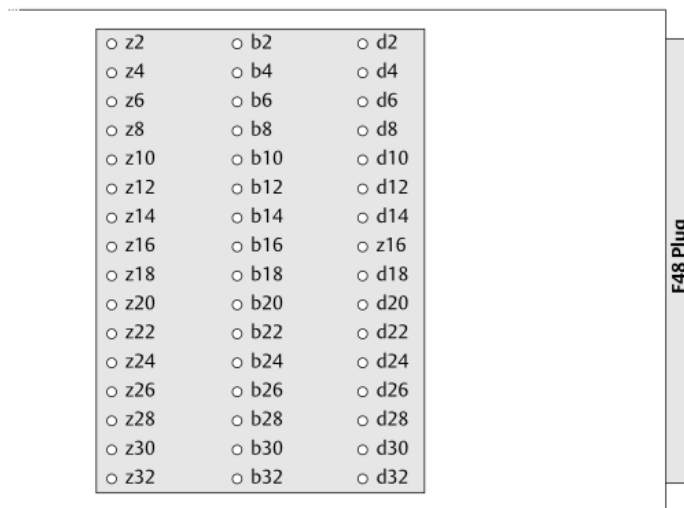

[Table 8-1](#) shows the assignment of the extension card terminals to the digital outputs.

Table 8-1: Extension card - terminal assignment

Terminals F48 extension card (wire switch board)	Slot output	A6500-UM		A6500-TP
z2	+24 V			
d2	+24 V ¹			
d28	Digital output 1	Danger alarm	Channel 1	Output 1
b28	Digital output 2	Alert alarm		Output 2
z28	Digital output 3	Channel OK		Output 3
d32	Digital output 4	Danger alarm	Channel 2	Output 4
b32	Digital output 5	Alert alarm		Output 5
z32	Digital output 6	Channel OK		Output 6

¹ Redundant supply, only available if A6500-xR is redundantly supplied.

Procedure

1. Install F48 extension cards in the respective slots of the A6500-xR System Rack. If cards are already installed in these slots, remove them beforehand.
2. Use a wire bridge to connect +24V from z2 to the respective digital output terminal. [Figure 8-2](#) shows, for example, the simulation of digital output 2, wire bridge from z2 to b28. The Relay Card detects input voltages in a range of +13 V to 32 V as logic high (logic 1) and voltages in a range of 0 V to 3 V as logic low (logic 0).

Figure 8-2: Example: Simulation of Digital output 1

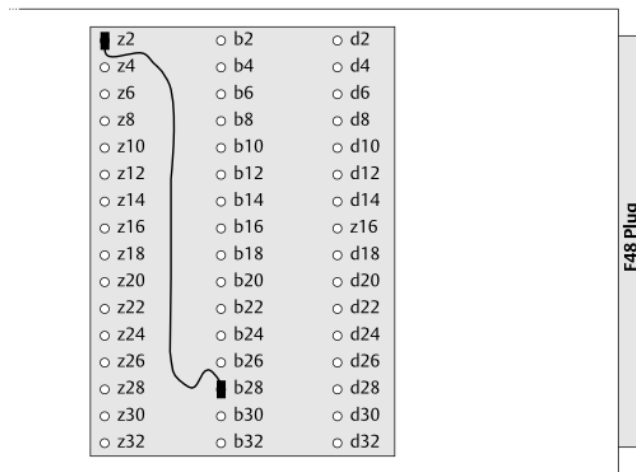

3. Check the proper work of the configured logic by means of the yellow front LEDs or the relay output at the backplane.
4. After the test, remove the F48 extension card. Reinstall the cards removed before this test.

8.1.2 Simulation by using the installed cards

Use the installed A6500-UM and A6500-TP cards to simulate digital output signals.

Procedure

1. Force the installed cards to generate messages by simulating measurement signals higher than the configured alarm limits. See operating manual A6500-UM Universal Measurement Card (MHM-97873), chapter "Functional check" for details.
2. Check the proper work of the configured logic by means of the yellow front LEDs or the relay output at the backplane.
3. After the test, restore the original state of the installed cards.

8.2 Maintenance

The A6500-RC Relay Card does not require any maintenance during normal operation.

9 Card replacement

Follow the steps listed below if a A6500-RC Relay Card needs to be replaced, for example, due to a defect.

⚠ CAUTION

Any work at the system may impair machine protection.

Procedure

1. Save the card configuration - if possible.
 - a) Connect the configuration device (PC/Laptop) through USB or Ethernet connection to the A6500-CC Com Card.
 - b) Start AMS Machine Studio. If connected through USB, the software automatically connects to the AMS 6500 ATG rack and opens the rack view. If connected through Ethernet, click **Connect ATG-System** to establish the connection.
 - c) Double-click the card to be replaced to open the online view of the card.
 - d) Click **Configure**. The card's configuration window opens.
 - e) Select **Files > Save as** to save the configuration file.
 - f) Close the configuration window.

AMS Machine Studio shows the card in online view in [1.c](#).

Do not close AMS Machine Studio.
2. Unfasten both screws at the front plate of the card to be replaced (see [Figure 3-2](#)).
3. Remove the card from the slot.
4. Install the new card.
5. Fasten the screws at the front plate to secure the card in the slot.

The card is automatically detected by AMS Machine Studio if the System Rack is still powered.
6. Load the configuration from the memory of the configuration device into the card.

If, due to a defect, there was no possibility of reading the configuration from the card to be replaced, use a back-up configuration file or create a new configuration.

 - a) Select the replaced card in the rack view. Double-click the new card to open the Online View.
 - b) Click **Configure** to open the configuration of the card.
 - c) Open the saved configuration file. Go to **File** and select **Open**.
 - d) Click **Send & close** to send the configuration to the new card.

The new card is ready for operation.

10 Technical data

Only specifications with indicated tolerances or limit values are obligatory. Data without tolerances or without error limits are informative data and not guaranteed. Technical modification, especially of the software, are subject to changes without notice. If not specified otherwise, all data are referred to an environmental temperature of +25°C.

10.1 Power supply

Nominal voltage	+24 V	redundant supply voltage inputs protected against polarity reversal
Permissible voltage range	+19 V to +32 V DC	in case of a single failure, supply voltage must not exceed the level of IEC 60204-1 or IEC 61131-2 (SELV/PELV)
Maximum power consumption	6 W	

10.2 Digital input

Number of inputs	66	
Logic low level	0 V to 3 V	not active
Logic high level	13 V to 32 V	active
Open input		open input detect as not active
Rated current	1 mA	
Rated power	24 mW	

10.3 Relay output

Number of outputs	16	
Type	SPDT	
Maximum voltage capacity	32 V DC/48 V AC	
Output load	AC1: 48 V/2 A DC1: 32 V/2 A DC-13: 24 V/1 A AC-15: 24 V/2 A	
Turn-on/turn-off time	10 ms NO contact 13 ms NC contact	without logic processing time
Rated current	2 A	
Rated power	96 W	

10.4 Data interface

Communication bus	RS 485	according to EIA485 standard
Bus termination	exterior	bus termination according to EIA485 can be provided externally

10.5 Mechanical design and environmental conditions

Mechanical design		
Rack slot	3RU/10HP	
Material front panel	aluminum, clear anodized	
Board dimensions	100x160 mm	euro-card format conform to IEC 60297
Board coating	Airborne contaminants resistance	ISA-S71.04-1985 airborne contaminants class G3, Conformal Coating
	Material: HumiSeal® 1B31 EPA	according to IPC-CC-830B and IPC-A 610
Card connector	type F48 male type C96 male	according to IEC 60603-2
Status indication	LEDs (3 mm)	one green OK LED and 16 yellow status LEDs at front panel
Weight	approximately 420 g	without packaging
Overall dimensions		see Figure 10-1

Environmental conditions		
Protection class	IP20	according to IEC 60529 rack mounted, otherwise IP00
Approval class for general safety	Class 2253 01	industrial automation products
	Class 2253 81	industrial automation products - (certified to U.S. standards)
Allowed degree of pollution	Category 2	according to IEC 61010-1
Operating temperature	-20°C to +70°C	with forced cooling ¹
	-20°C to +55°C	without forced cooling
Storage temperature	-40°C to +85°C	
Relative humidity	5 to 95%	noncondensing
Shock	150 m/s ²	according to IEC 60068-2-27, 4000 shocks per axis

Environmental conditions		
Vibration	0.15 mm 20 m/s ²	10 to 55 Hz 55 to 150 Hz according to IEC 60068-2-6, float sinus, three axis
Operating altitude	<2000 m	above see level
Environmental area	Indoor use only	
External devices		in case of a single failure, externally connected devices must not exceed the level of IEC60204-1 or IEC 61131-2

1 An airflow of $\geq 440 \text{ m}^3/\text{h}$ is required.

Figure 10-1: Dimensions

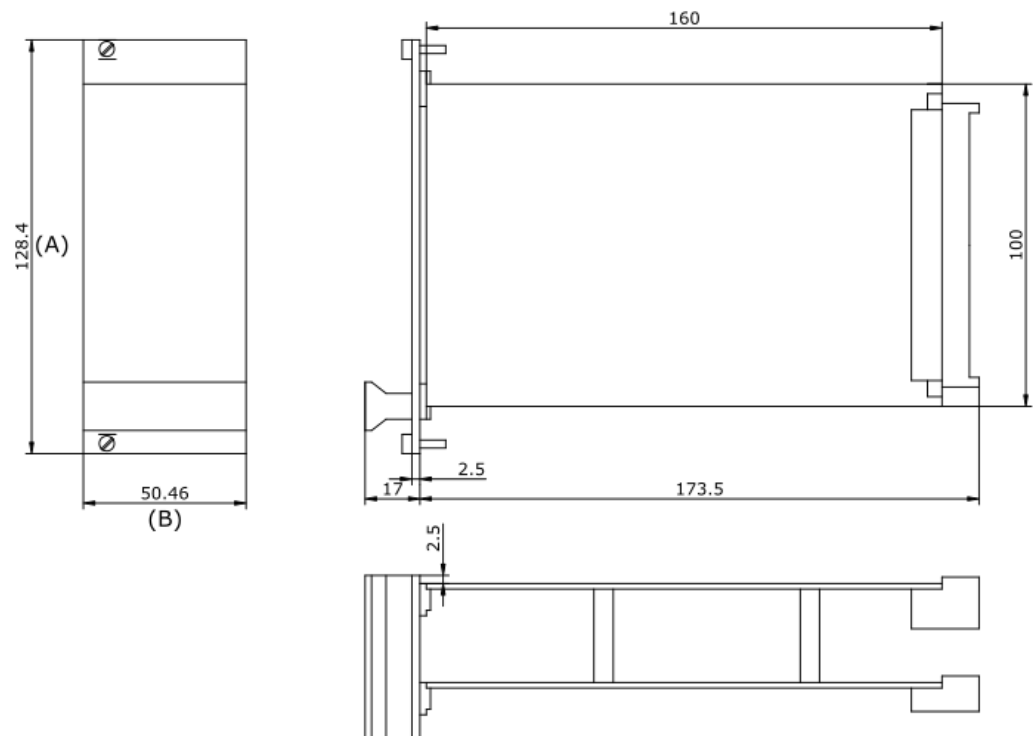

A. 3 RU

B. 10 HP

All dimensions in mm

11 Certificates



EU-Declaration of Conformity (Translation)

We: epro GmbH, Jöbkesweg 3, 48599 Gronau
declare under our sole responsibility that following product(s):

Product designation:	AMS 6500 ATG
Product description:	Protection system for rotating equipment with integrated prediction capabilities
Part numbers	A6500-CC A6500-UM A6500-TP A6500-RC A6500-SR A6500-RR A6500-FR

are in conformity with the terms of the directives mentioned below including any amendment valid at the date of declaration:

2014/30/EU	Electromagnetic compatibility
2014/34/EU	Equipment and protective system intended for use in potentially explosive atmospheres
2011/65/EU	The restriction of the use of certain hazardous substances in electrical and electronic equipment

Following harmonized standards have been applied:

2014/30/EU	EN 61326-1	Electrical equipment for measurement, control and laboratory use. EMC requirements.
2014/34/EU	EN 60079-0	Explosive atmospheres - Part 1: General requirements
		Part 0: Equipment - General requirements
	EN 60079-7	Explosive atmospheres - Part 7: Equipment protection by increased safety "e"
2011/65/EU	EN 63000	Technical documentation for the assessment of electrical and electronic products with respect to the restriction of hazardous substances

For the type examination according to EN 60079-0 and EN 60079-7 the following notified body has been involved;

DEKRA EXAM GmbH
Type examination certificate BVS 16 ATEX E 016 U

Authorized person for technical documentation:
Bruno Hecker, Jöbkesweg 3, 48599 Gronau

Gronau, 06 May 2022
Place, Date

Managing Director

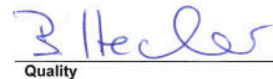
Quality



EU-Konformitätserklärung (Original)



Wir: epro GmbH, Jöbkesweg 3, 48599 Gronau
erklären in alleiniger Verantwortung, dass folgende Produkte:

Produktbezeichnung: AMS 6500 ATG
Produktbeschreibung: Schutzsystem für rotierende Maschinen mit integrierten Diagnosemöglichkeiten
Artikelnummern: A6500-CC
A6500-UM
A6500-TP
A6500-RC
A6500-SR
A6500-RR
A6500-FR

den Bestimmungen der unten genannten Richtlinien, einschließlich deren zum Zeitpunkt der Erklärung geltenden Änderungen, entsprechen:

2014/30/EU	Elektromagnetische Verträglichkeit
2014/34/EU	Geräte und Schutzsysteme zur bestimmungsgemäßen Verwendung in explosionsgefährdeten Bereichen
2011/65/EU	Beschränkung der Verwendung bestimmter gefährlicher Stoffe in Elektro- und Elektronikgeräten

Folgende harmonisierte Normen wurden angewandt:

2014/30/EU	EN 61326-1	Elektrische Mess-, Steuer-, Regel- und Laborgeräte – EMV Anforderungen - Teil 1: Allgemeine Anforderungen
2014/34/EU	EN 60079-0	Explosionsgefährdete Bereiche - Teil 0: Betriebsmittel – Allgemeine Anforderungen
	EN 60079-7	Explosionsgefährdete Bereiche - Teil 7: Geräteschutz durch erhöhte Sicherheit "e"
2011/65/EU	EN 63000	Technische Dokumentation zur Beurteilung von Elektro- und Elektronikgeräten hinsichtlich der Beschränkung gefährlicher Stoffe

Für die Baumusterprüfung nach EN 60079-0 und EN 60079-7 ist folgende Benannte Stelle eingeschaltet worden:

DEKRA EXAM GmbH
Baumusterprüfnummer BVS 16 ATEX E 016 U

Bevollmächtigter für die Technische Dokumentation:

Bruno Hecker, Jöbkesweg 3, 48599 Gronau

Gronau, 06. Mai 2022
Ort, Datum

Geschäftsführung

Qualitätsmanagement



UKCA-Declaration of Conformity

We, the manufacturer: epro GmbH, Jöbkesweg 3, 48599 Gronau, Germany
declare under our sole responsibility that following product(s):

Product designation:	AMS 6500 ATG
Product description:	Protection system for rotating equipment with integrated prediction capabilities
Part numbers	A6500-CC A6500-UM A6500-TP A6500-RC A6500-SR A6500-RR

are in conformity with the terms of the directives mentioned below including any amendment valid at the date of declaration:

S.I. 2016 No. 1091	Electromagnetic Compatibility Regulations 2016
S.I. 2016 No. 1107	Equipment and Protective Systems Intended for use in Potentially Explosive Atmospheres Regulations 2016
S.I. 2012 No. 3032	The restriction of the use of certain hazardous substances in electrical and electronic equipment

Following standards have been applied:

S.I. 2016 No. 1091	EN 61326-1	Electrical equipment for measurement, control and laboratory use. EMC requirements. Part 1. General requirements
S.I. 2016 No. 1107	EN 60079-0	Explosive atmospheres -Part 0: Equipment- General requirements
	EN 60079-7	Explosive atmospheres - Part 7: Equipment protection by increased safety "e"
S.I. 2012 No. 3032	EN IEC 63000	Technical documentation for the assessment of electrical and electronic products with respect to the restriction of hazardous substances

For the type examination according to EN 60079-0 and EN 60079-7 the following notified body has been involved:

DEKRA Testing and Certification GmbH
Type examination certificate BVS 16 ATEX E 016 X

Authorized person for technical documentation:

Bruno Hecker, Jöbkesweg 3, 48599 Gronau, Germany

Authorized Representative:

Emerson Process Management Limited,
company No 00671801
Meridian East,
Leicester
LE19 1UX, United Kingdom
Regulatory Compliance Department
email: ukproductcompliance@emerson.com
Phone: +44 11 6282 23 64

M. Fränzer
Managing Director

B. Hecker
Quality

Place, Date: Gronau, 13 September 2022



Emerson Process Management
1100 W. Louis Henna Blvd.
Round Rock, TX 78681

Statement Regarding the China RoHS Compliance of Emerson Product – A6500-UM

Please refer to Table 1 for the names and contents of the toxic or hazardous substances or elements contained in Emerson products.

Table 1: Names and Contents of Toxic or Hazardous Substances or Elements

表1：有毒有害物质或元素的名称及含量

部件名称 Part Name	有毒有害物质或元素 Toxic or hazardous Substances and Elements						
	铅 Lead (Pb)	汞 Mercury (Hg)	镉 Cadmium (Cd)	六价铬 Hexavalent Chromium (Cr (VI))	多溴联苯 Polybrominated biphenyls (PBB)	多溴二苯醚 Polybrominated diphenyl ethers (PBDE)	
印刷电路板组装 PC BD ASSY	X	0	0	0	0	0	
面板 FACEPLATE	0	0	0	0	0	0	
印刷电路板组装支持 PC BD ASSY SUPPORT	0	0	0	0	0	0	
0 表示该有毒有害物质在该部件所有均质材料中的含量均在GB/T 26572规定的限量要求以下 0: Indicates that this toxic or hazardous substance contained in all of the homogeneous materials for this part is below the limit requirement in GB/T 26572.							
X 表示该有毒有害物质至少在该部件的某一均质材料中的含量超出GB/T 26572规定的限量要求。 X: Indicates that this toxic or hazardous substance contained in at least one of the homogeneous materials used for this part is above the limit requirement in GB/T 26572.							
环保期限 (EFUP) 的产品及其部件是每个列出的符号，除非另有标明。使用期限只适用于产品在产品手册中规定的条件下工作 The Environmentally Friendly Period (EFUP) for the product and its parts are per the symbol listed, unless otherwise marked. Use Period is valid only when the product is operated under the conditions defined in the product manual.							

James McFerrin
Environmental Compliance Manager PSG
T 512.832.3271 E james.mcferrin@emerson.com



Emerson Process Management
1100 W. Louis Henna Blvd.
Round Rock, TX 78681

Statement Regarding the China RoHS Compliance of Emerson Product – A6500-TP

Please refer to Table 1 for the names and contents of the toxic or hazardous substances or elements contained in Emerson products.

Table 1: Names and Contents of Toxic or Hazardous Substances or Elements
表1：有毒有害物质或元素的名称及含量

部件名称 Part Name	有毒有害物质或元素 Toxic or hazardous Substances and Elements						
	铅 Lead (Pb)	汞 Mercury (Hg)	镉 Cadmium (Cd)	六价铬 Hexavalent Chromium (Cr (VI))	多溴联苯 Polybrominated biphenyls (PBB)	多溴二苯醚 Polybrominated diphenyl ethers (PBDE)	
印刷电路板组装 PC BD ASSY	X	0	0	0	0	0	
面板 FACEPLATE	0	0	0	0	0	0	
印刷电路板组装支持 PC BD ASSY SUPPORT	0	0	0	0	0	0	
<p>0 表示该有毒有害物质在该部件所有均质材料中的含量均在GB/T 26572规定的限量要求以下 0: Indicates that this toxic or hazardous substance contained in all of the homogeneous materials for this part is below the limit requirement in GB/T 26572.</p> <p>X 表示该有毒有害物质至少在该部件的某一均质材料中的含量超出GB/T 26572规定的限量要求。 X: Indicates that this toxic or hazardous substance contained in at least one of the homogeneous materials used for this part is above the limit requirement in GB/T 26572</p> <p>环保期限 (EFUP) 的产品及其部件是每个列出的符号，除非另有标明。使用期限只适用于产品在产品手册中规定的条件下工作 The Environmentally Friendly Period (EFUP) for the product and its parts are per the symbol listed, unless otherwise marked. Use Period is valid only when the product is operated under the conditions defined in the product manual.</p>							

James McFerrin
Environmental Compliance Manager PSG
T 512.832.3271 E james.mcferrin@emerson.com



Emerson Process Management
1100 W. Louis Henna Blvd.
Round Rock, TX 78681

Statement Regarding the China RoHS Compliance of Emerson Product – A6500-RC

Please refer to Table 1 for the names and contents of the toxic or hazardous substances or elements contained in Emerson products.

Table 1: Names and Contents of Toxic or Hazardous Substances or Elements

表1：有毒有害物质或元素的名称及含量

部件名称 Part Name	有毒有害物质或元素 Toxic or hazardous Substances and Elements						
	铅 Lead (Pb)	汞 Mercury (Hg)	镉 Cadmium (Cd)	六价铬 Hexavalent Chromium (Cr (VI))	多溴联苯 Polybrominated biphenyls (PBB)	多溴二苯醚 Polybrominated diphenyl ethers (PBDE)	
印刷电路板组装 PC BD ASSY	X	0	0	0	0	0	
面板 FACEPLATE	0	0	0	0	0	0	
印刷电路板组装支持 PC BD ASSY SUPPORT	0	0	0	0	0	0	
<p>0 表示该有毒有害物质在该部件所有均质材料中的含量均在GB/T 26572规定的限量要求以下 0: Indicates that this toxic or hazardous substance contained in all of the homogeneous materials for this part is below the limit requirement in GB/T 26572.</p> <p>X 表示该有毒有害物质至少在该部件的某一均质材料中的含量超出GB/T 26572规定的限量要求。 X: Indicates that this toxic or hazardous substance contained in at least one of the homogeneous materials used for this part is above the limit requirement in GB/T 26572</p> <p>环保期限 (EFUP) 的产品及其部件是每个列出的符号，除非另有标明。使用期限只适用于产品在产品手册中规定的条件下工作 The Environmentally Friendly Period (EFUP) for the product and its parts are per the symbol listed, unless otherwise marked. Use Period is valid only when the product is operated under the conditions defined in the product manual.</p>							

James McFerrin
Environmental Compliance Manager PSG
T 512.832.3271 E james.mcferrin@emerson.com



Emerson Process Management
1100 W. Louis Henna Blvd.
Round Rock, TX 78681

Statement Regarding the China RoHS Compliance of Emerson Product – A6500-CC

Please refer to Table 1 for the names and contents of the toxic or hazardous substances or elements contained in Emerson products.

Table 1: Names and Contents of Toxic or Hazardous Substances or Elements

表1：有毒有害物质或元素的名称及含量

部件名称 Part Name	有毒有害物质或元素 Toxic or hazardous Substances and Elements						
	铅 Lead (Pb)	汞 Mercury (Hg)	镉 Cadmium (Cd)	六价铬 Hexavalent Chromium (Cr (VI))	多溴联苯 Polybrominated biphenyls (PBB)	多溴二苯醚 Polybrominated diphenyl ethers (PBDE)	
印刷电路板组装 PC BD ASSY	X	0	0	0	0	0	
面板 FACEPLATE	0	0	0	0	0	0	
印刷电路板组装支持 PC BD ASSY SUPPORT	0	0	0	0	0	0	
<p>0 表示该有毒有害物质在该部件所有均质材料中的含量均在GB/T 26572规定的限量要求以下 0: Indicates that this toxic or hazardous substance contained in all of the homogeneous materials for this part is below the limit requirement in GB/T 26572.</p> <p>X 表示该有毒有害物质至少在该部件的某一均质材料中的含量超出GB/T 26572规定的限量要求。 X: Indicates that this toxic or hazardous substance contained in at least one of the homogeneous materials used for this part is above the limit requirement in GB/T 26572</p> <p>环保期限 (EFUP) 的产品及其部件是每个列出的符号，除非另有标明，使用期限只适用于产品在产品手册中规定的条件下工作 The Environmentally Friendly Period (EFUP) for the product and its parts are per the symbol listed, unless otherwise marked. Use Period is valid only when the product is operated under the conditions defined in the product manual.</p>							

James McFerrin
Environmental Compliance Manager PSG
T 512.832.3271 E james.mcferrin@emerson.com



Emerson Process Management
1100 W. Louis Henna Blvd.
Round Rock, TX 78681

Statement Regarding the China RoHS Compliance of Emerson Product – A6500-SR

Please refer to Table 1 for the names and contents of the toxic or hazardous substances or elements contained in Emerson products.

Table 1: Names and Contents of Toxic or Hazardous Substances or Elements

表1：有毒有害物质或元素的名称及含量

部件名称 Part Name	有毒有害物质或元素 Toxic or hazardous Substances and Elements						
	铅 Lead (Pb)	汞 Mercury (Hg)	镉 Cadmium (Cd)	六价铬 Hexavalent Chromium (Cr (VI))	多溴联苯 Polybrominated biphenyls (PBB)	多溴二苯醚 Polybrominated diphenyl ethers (PBDE)	
印刷电路板组装 PC BD ASSY	X	0	0	0	0	0	
围堰 ENCLOSURE	0	0	0	0	0	0	
硬件 HARDWARE	0	0	0	0	0	0	
印刷电路板组装支持 PC BD ASSY SUPPORT	0	0	0	0	0	0	
0 表示该有毒有害物质在该部件所有均质材料中的含量均在GB/T 26572规定的限量要求以下 0: Indicates that this toxic or hazardous substance contained in all of the homogeneous materials for this part is below the limit requirement in GB/T 26572.							
X 表示该有毒有害物质至少在该部件的某一均质材料中的含量超出GB/T 26572规定的限量要求。 X: Indicates that this toxic or hazardous substance contained in at least one of the homogeneous materials used for this part is above the limit requirement in GB/T 26572.							
环保期限 (EFUP) 的产品及其部件是每个列出的符号，除非另有标明。使用期限只适用于产品在产品手册中规定的条件下工作 The Environmentally Friendly Period (EFUP) for the product and its parts are per the symbol listed, unless otherwise marked. Use Period is valid only when the product is operated under the conditions defined in the product manual.							

James McFerrin
Environmental Compliance Manager PSG
T 512 832 3271 E james.mcferrin@emerson.com



Emerson Process Management
1100 W. Louis Henna Blvd.
Round Rock, TX 78681

Statement Regarding the China RoHS Compliance of Emerson Product – A6500-RR

Please refer to Table 1 for the names and contents of the toxic or hazardous substances or elements contained in Emerson products.

Table 1: Names and Contents of Toxic or Hazardous Substances or Elements

表1：有毒有害物质或元素的名称及含量

部件名称 Part Name	有毒有害物质或元素 Toxic or hazardous Substances and Elements						
	铅 Lead (Pb)	汞 Mercury (Hg)	镉 Cadmium (Cd)	六价铬 Hexavalent Chromium (Cr (VI))	多溴联苯 Polybrominated biphenyls (PBB)	多溴二苯醚 Polybrominated diphenyl ethers (PBDE)	
印刷电路板组装 PC BD ASSY	X	0	0	0	0	0	
围堵 ENCLOSURE	0	0	0	0	0	0	
硬件 HARDWARE	0	0	0	0	0	0	
印刷电路板组装支持 PC BD ASSY SUPPORT	0	0	0	0	0	0	
O 表示该有毒有害物质在该部件所有均质材料中的含量均在GB/T 26572规定的限量要求以下 O: Indicates that this toxic or hazardous substance contained in all of the homogeneous materials for this part is below the limit requirement in GB/T 26572.							
X 表示该有毒有害物质至少在该部件的某一均质材料中的含量超出GB/T 26572规定的限量要求。 X: Indicates that this toxic or hazardous substance contained in at least one of the homogeneous materials used for this part is above the limit requirement in GB/T 26572.							
环保期限 (EFUP) 的产品及其部件是每个列出的符号，除非另有标明。使用期限只适用于产品在产品手册中规定的条件下工作 The Environmentally Friendly Period (EFUP) for the product and its parts are per the symbol listed, unless otherwise marked. Use Period is valid only when the product is operated under the conditions defined in the product manual.							

James McFerrin
Environmental Compliance Manager PSG
T 512 832 3271 E james.mcferrin@emerson.com



Emerson Automation Solutions
1100 W. Louis Henna Blvd.
Round Rock, TX 78681

Statement Regarding the China RoHS Compliance of Emerson Product - A6500-FR

Please refer to Table 1 for the names and contents of the toxic or hazardous substances or elements contained in Emerson products.

Table 1: Names and Contents of Toxic or Hazardous Substances or Elements

表1：有毒有害物质或元素的名称及含量

部件名称 Part Name	有毒有害物质或元素 Toxic or hazardous Substances and Elements						
	铅 Lead (Pb)	汞 Mercury (Hg)	镉 Cadmium (Cd)	六价铬 Hexavalent Chromium (Cr (VI))	多溴联苯 Polybrominated biphenyls (PBB)	多溴二苯醚 Polybrominated diphenyl ethers (PBDE)	
印刷电路板组装 PC BD ASSY	X	0	0	0	0	0	
硬件 HARDWARE	0	0	0	0	0	0	
<p>0 表示该有毒有害物质在该部件所有均质材料中的含量均在GB/T 26572规定的限量要求以下 0: Indicates that this toxic or hazardous substance contained in all of the homogeneous materials for this part is below the limit requirement in GB/T 26572.</p> <p>X 表示该有毒有害物质至少在该部件的某一均质材料中的含量超出GB/T 26572规定的限量要求。 X: Indicates that this toxic or hazardous substance contained in at least one of the homogeneous materials used for this part is above the limit requirement in GB/T 26572</p> <p>环保期限 (EFUP) 的产品及其部件是每个列出的符号，除非另有标明。使用期限只适用于产品在产品手册中规定的条件下工作 The Environmentally Friendly Period (EFUP) for the product and its parts are per the symbol listed, unless otherwise marked. Use Period is valid only when the product is operated under the conditions defined in the product manual.</p>							

James McFerrin
Environmental Compliance Manager
Systems and Solutions
T 512 832 3271 E james.mcferrin@emerson.com



Emerson Automation Solutions
1100 W. Louis Henna Blvd.
Round Rock, TX 78681

Statement Regarding the China RoHS Compliance of Emerson Product - A6500-PE

Please refer to Table 1 for the names and contents of the toxic or hazardous substances or elements contained in Emerson products.

Table 1: Names and Contents of Toxic or Hazardous Substances or Elements

表1：有毒有害物质或元素的名称及含量

部件名称 Part Name	有毒有害物质或元素 Toxic or hazardous Substances and Elements						
	铅 Lead (Pb)	汞 Mercury (Hg)	镉 Cadmium (Cd)	六价铬 Hexavalent Chromium (Cr (VI))	多溴联苯 Polybrominated biphenyls (PBB)	多溴二苯醚 Polybrominated diphenyl ethers (PBDE)	
印刷电路板组装 C PC BD ASSY C	X	0	0	0	0	0	
印刷电路板组装 PC BD ASSY	X	0	0	0	0	0	
硬件 HARDWARE	0	0	0	0	0	0	
<p>0 表示该有毒有害物质在该部件所有均质材料中的含量均在GB/T 26572规定的限量要求以下 0: Indicates that this toxic or hazardous substance contained in all of the homogeneous materials for this part is below the limit requirement in GB/T 26572.</p> <p>X 表示该有毒有害物质至少在该部件的某一均质材料中的含量超出GB/T 26572规定的限量要求。 X: Indicates that this toxic or hazardous substance contained in at least one of the homogeneous materials used for this part is above the limit requirement in GB/T 26572</p> <p>环保期限 (EFUP) 的产品及其部件是每个列出的符号，除非另有标明。使用期限只适用于产品在产品手册中规定的条件下工作 The Environmentally Friendly Period (EFUP) for the product and its parts are per the symbol listed, unless otherwise marked. Use Period is valid only when the product is operated under the conditions defined in the product manual.</p>							

James McFerrin
Environmental Compliance Manager
Systems and Solutions
T 512 832 3271 E james.mcferrin@emerson.com

A Card related system events

The possible system events provided by the A6500-RC card are listed in [Table A-1](#). See column **Cross reference / Note** for further event related information. See Machine Studio – General Functions manual for a common description of the system events.

Table A-1: Card events

Event	Cross reference / Note
Temperature danger alarm entered	Overview , see Card health
Temperature danger alarm left	
Temperature alert alarm entered	
Temperature alert alarm left	
EEPROM error	Replace the card, if this does not solve the problem, contact support, see Technical support .
Temperature chip error	
Digital input chip error	
Relay power error	
Pulse-width modulation error	
Feedback voltage of relays too low	
Flash memory access error	
Card configured	Send a configuration
Card configuration error	Try to send the configuration again, if this does not solve the problem, contact support, see Technical support .
Card reboots	-/-
Card starts up	-/-
Card started up successfully	-/-
Warm start finished	Software initialized start of the card is completed
Error while erasing flash memory	Try again, if this does not solve the problem, contact support, see Technical support .
EEPROM has been reset	-/-
Events have been lost because too many have occurred within a short time	Basic , see Enable marker events
Digital output x ¹ on	Digital outputs
Digital output x ¹ off	
Marker x ² on	Marker
Marker x ² off	

Table A-1: Card events *(continued)*

Event	Cross reference / Note
Software input x^3 on	Software inputs
Software input x^3 off	

- 1 $x = 1$ to 16
- 2 $x = 1$ to 64
- 3 $x = 1$ to 16

Index

B

Basic 28

C

Card replacement 65
CCC Certification 10
Close configuration 28
Compare 24
Configuration 22
CSA 16

D

Delete 36, 39, 41, 43, 47, 48, 51, 54
Digital input 34
Digital output 47
Disposal 9

E

Editor 22, 27
ESD 12

H

History 25

L

Logic elements 30

M

marker 40
Module 29

N

Negation 36, 39, 43, 46, 51, 54
New 22
No configuration 23, 58
Not in sync 57

O

Online 27
Overview 58

P

Properties 22

R

Reload 23, 56
Rename 36, 39, 43, 51
Report 24
Reset to factory default 23
Ribbon command bar 22

S

Send 54
Send & close 23, 32, 55
Show History/Drafts 25
Software inputs 37
Special function 52
Standard logic gate 31

T

Technical support 8
Timer 44

Emerson
12001 Technology Drive
Eden Prairie, MN 55344 USA
T 1(952)828-3000
www.Emerson.com

Emerson
835 Innovation Drive
Knoxville, TN 37932 USA
T +1 865-675-2400
F +1 865-218-1401
www.Emerson.com

Emerson
Jöbkesweg 3
48599 Gronau
Germany
T +49 2562 709 0
F +49 2562 709 401
www.Emerson.com/ams

©2024, Emerson. All rights reserved.

The contents of this publication are presented for informational purposes only, and while diligent efforts were made to ensure their accuracy, they are not to be construed as warranties or guarantees, express or implied, regarding the products or services described herein or their use or applicability. All sales are governed by our terms and conditions, which are available on request. We reserve the right to modify or improve the designs or specifications of our products at any time without notice.

The Emerson logo is a trademark and service mark of Emerson Electric Co. The AMS logo is a mark of one of the Emerson family of companies. All other marks are the property of their respective owners.

