



ANDERSON GREENWOOD SAFETY SELECTOR VALVE

A dual pressure relief device system that provides a safe, efficient method of switching from an active PRV to a standby, maintaining system overpressure protection



FEATURES

- Provides high C_v values, resulting in less than 3% pressure drop to the active PRV inlet, reducing destructive valve chatter.
- One minimally sized penetration into the vessel or pipe reduces costs.
- Reduces field installation costs and space requirements through preassembled and compact design.
- Provides process isolation of standby PRV.
- Allows PRV maintenance without process shutdown.
- Bleed valve under each PRV vents entrapped process effectively and safely prior to removal for maintenance.
- Clear, positive indication of active PRV.
- Foolproof provisions for dual padlocking in either PRV position.
- Tested packing design and minimal leak points reduce fugitive emissions.
- No seat lapping required for maintenance. Minimal spare parts reduce cost of ownership.
- Simple operation with built-in seat equalization and no special tools minimizes total valve operating time.
- Tandem system available for dual PRV's discharging to a closed header system.

GENERAL APPLICATION

Safety selector valves can be used in gas/vapor, steam, liquid or in two phase service. They are also suitable for application on Section I boilers with a maximum allowable working pressure of 800 psig.

APPROVALS

API RP520 Part II
 API SCPRS
 API SCI
 ASME Section VIII, Division 1, Appendix M and Section XIII, Appendix B;
 UG 156 (d)
 Det Norske Veritas (DNV)

Testing

ASTM E427

TECHNICAL DATA

Materials: Carbon steel, stainless steel, Duplex, other alloys
 Seat: PTFE, PEEK or graphite
 Sizes: NPS 1-10 (DN 25-250)
 Pressure class: ANSI class 150 to 2500 ASME up to 2500
 Temperature standard range: -423°F to 800°F (-253°C to 427°C)

ANDERSON GREENWOOD SAFETY SELECTOR VALVE

DUAL PRESSURE RELIEF SYSTEMS

SSV VS TRADITIONAL DUAL PRESSURE RELIEF DEVICE SYSTEMS

The Safety Selector Valve (SSV) was developed in response to the growing demand for cost-effective, dual pressure relief valve and/or rupture disc installations. It is designed specifically to function as an effective 'switchover' device that permits routine or emergency servicing of redundant pressure relief devices with no process interruption, providing continuous system overpressure protection.

Traditional dual pressure relief device systems

Previously, bulky and expensive piping fabrications or total shutdown were the only methods for servicing pressure relief devices. These systems required either two separate vessel penetrations with mechanically-linked block valves or a 3-way block valve that commonly resulted in high inlet pressure loss, excessive turbulence to the active pressure relief device and multiple leak points.

The SSV solves these problems. It is easy to install, requiring only one vessel penetration in the same size as the pressure relief valve inlet. Its unique design provides less than 3% pressure drop to the active pressure relief valve inlet when used with the largest API orifice available in a given valve size, in accordance with API RP520, Part II, ASME Section VIII and Section XIII guidelines.

Using API Standard 526 direct acting spring loaded valves, the comparative pressure drop through the safety selector valve versus the same size 3-way ball valve is as follows:

	2" 2J3	3" 3L4	4" 4P6	6" 6R8	8" 8T10
SSV	1.50%	0.86%	1.42%	1.37%	1.31%
3-way ball	6.36%	5.65%	9.30%	10.6%	8.69%

TRADITIONAL DUAL PRESSURE RELIEF DEVICE SYSTEMS

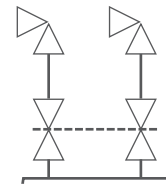

Interlocking block valve with two vessel penetrations

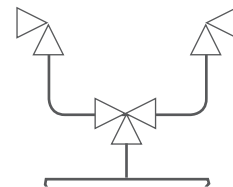

3-way block valve with pipe elbows

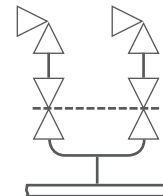

Interlocking block valve with pipe tee and elbows

ANDERSON GREENWOOD SAFETY SELECTOR VALVE

OPERATION

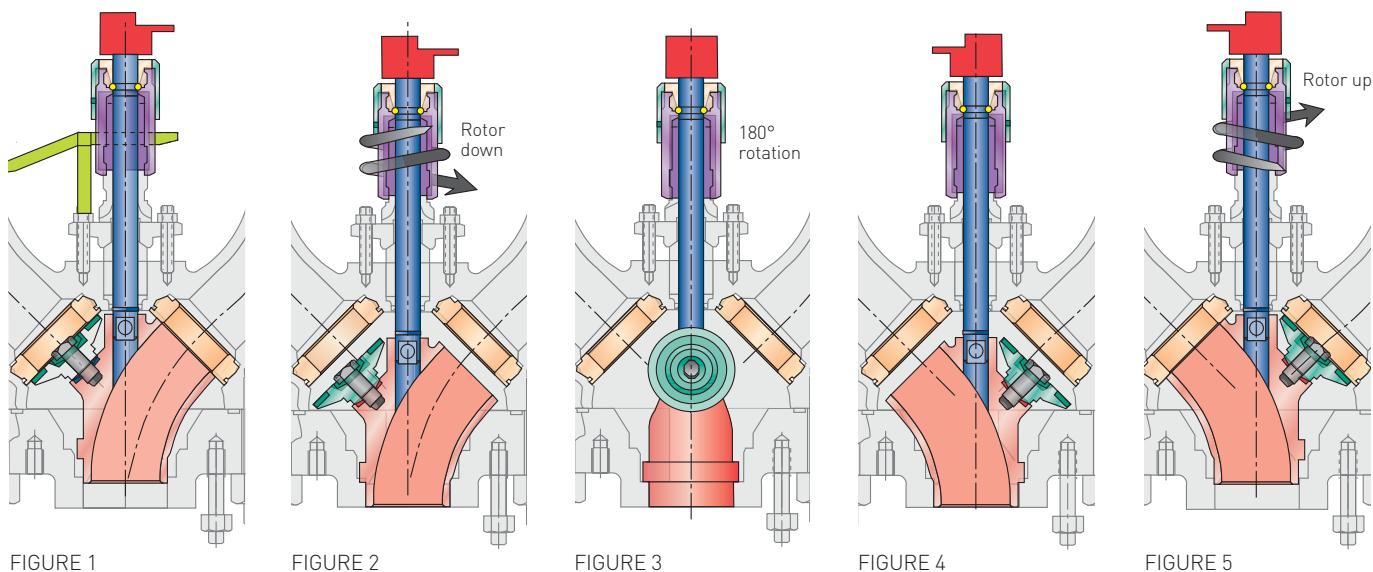

FIGURE 1

FIGURE 2





FIGURE 3

FIGURE 4

FIGURE 5

The safety selector valve body houses a uniquely designed switching mechanism. The internal rotor smoothly diverts flow to either pressure relief device, which may be direct spring operated valves, pilot operated valves or rupture discs. The inactive device is totally isolated by external adjustment (Figures 1 and 5).

No special tools are necessary for switching. To begin switchover, the padlocks or seals are removed, the lock hasp is opened and the retraction bushing is rotated to its stop (Figure 2). This lowers the isolation disc from the nozzle under the standby valve and temporarily 'floats' it in the main valve cavity. The index shaft is then rotated 180° to the alternate channel (Figures 3 and 4). The retraction bushing is then raised, securely seating the isolation disc beneath the valve to be taken out of service (Figure 5). A red pointer indicates which device is in service and double padlocking provisions allow the SSV to be locked in either position. The padlocks or car seals can only be installed with the internals in the proper position.

-  Retraction bushing
-  Isolation disc
-  Red pointer
-  Lock hasp
-  Nozzle
-  Index shaft

ANDERSON GREENWOOD SAFETY SELECTOR VALVE

SPECIFICATIONS AND APPLICATIONS

SPECIFICATIONS

Size	Flow efficiency (C _v)	Maximum pressure rating psig (barg) (at 100°F/ 37.8°C)		Soft goods Maximum temperature rating °F (°C) / PEEK/		
		CS body ⁽¹⁾	SS body ⁽¹⁾	PTFE	Grafoil®	Grafoil®
1"	34	6170 (425.5)	6000 (413.8)	400 (204.4)	600 (315)	800 (426.7)
1.5"	121	6170 (425.5)	6000 (413.8)	400 (204.4)	600 (315)	800 (426.7)
2"	255	6170 (425.5)	6000 (413.8)	400 (204.4)	600 (315)	800 (426.7)
3"	612	2220 (153.1)	2160 (150.0)	400 (204.4)	600 (315)	800 (426.7)
4"	1061	2220 (153.1)	2160 (150.0)	400 (204.4)	600 (315)	800 (426.7)
6"	2713	1480 (102.1)	1440 (99.3)	400 (204.4)	600 (315)	800 (426.7)
8"	4512	1480 (102.1)	1440 (99.3)	400 (204.4)	600 (315)	800 (426.7)
10"	6930	740 (51.0)	720 (49.6)	400 (204.4)	600 (315)	800 (426.7)

NOTE

1. Temperature range is limited according to body material of construction as follows:

- CS -20°F to 800°F (-28.9°C to 426.7°C)
- SS -423°F to 800°F (-252.8°C to 426.7°C)

APPLICATIONS

Liquid/two phase service

Safety Selector Valves can be used in gas/ vapor, steam, liquid or two-phase service. Figure 1 shows an Anderson Greenwood Series 400 pilot valve relieving on liquid only. Figure 2 shows the same valve transitioning to two phase flow as gas becomes entrained in the relief stream.

Section I steam service

As per ASME Section I Boiler and Pressure Vessel Code Case 2254, the Safety Selector Valve can be installed to provide a back-up safety valve for boilers with a maximum allowable working pressure (MAWP) of 800 psig or less.

The code case requires that the switchover device must provide: positive locking, external bleed valves, certified C_v values. The SSV will provide the highest flow efficiency (C_v) of any switchover device in the same nominal pipe size, enabling it to be used with most manufacturers' flanged Section I Boiler valves. To ensure complete compliance with the code case, please provide the model number and set pressure of the safety valves to be used.

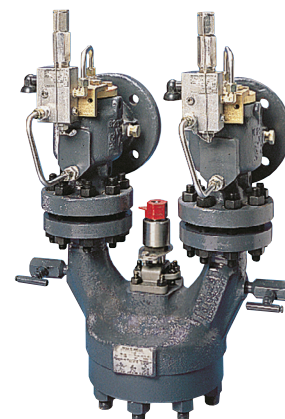

FIGURE 1



FIGURE 2



ANDERSON GREENWOOD SAFETY SELECTOR VALVE

COMPONENT PARTS

1½" TO 10" SIZES

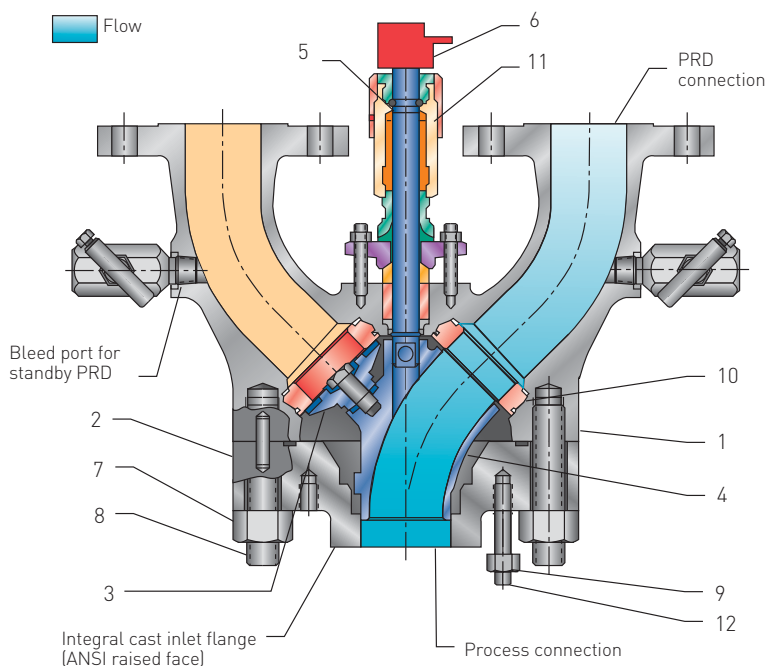

MATERIALS OF CONSTRUCTION

Description	Material	
	CS	SS
1. Body	SA216-WCB CS	SA351-CF8M SS
2. Base	SA216-WCB CS	SA351-CF8M SS
3. Isolation disc	17-4 SS	17-4 SS
4. Rotor	A351-CF8M SS	A351-CF8M SS
5. Index shaft	17-4 SS	17-4 SS
6. Indicator	A351-CF8M SS	A351-CF8M SS
7. Body/base nut	SA194-2H CS	SA194-8M SS
8. Body/base stud	SA193-B7 CS	SA193-B8M SS
9. Process connection nut	SA194-2H CS	SA194-8M SS
10. Seat	A479-316 SS or A351-CF8M SS	A479-316 SS or A351-CF8M SS
11. Retraction bushing*	17-4 SS*	17-4 SS*
12. Process connection stud	SA193-B7 CS	SA193-B8M SS

1" SIZE ONLY

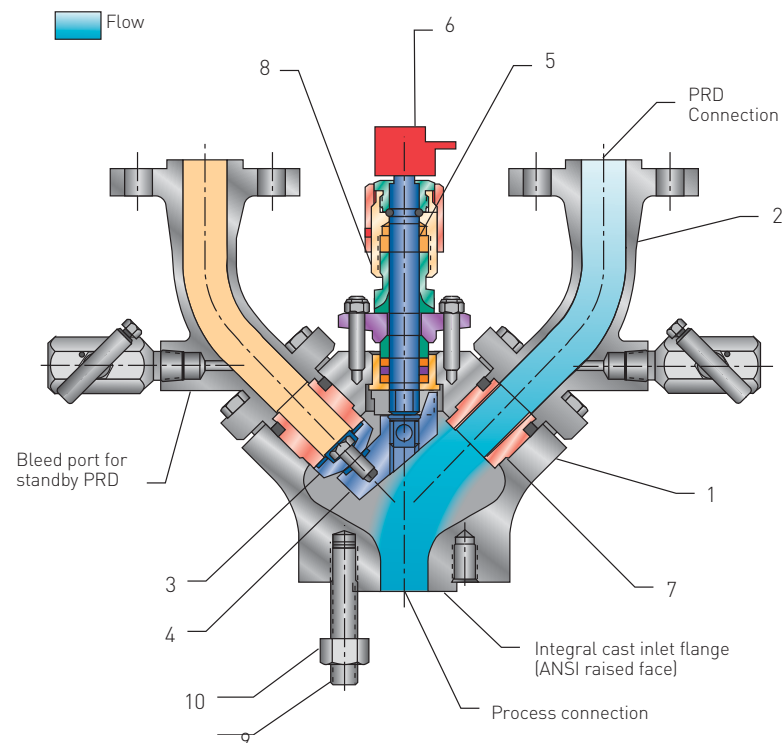

MATERIALS OF CONSTRUCTION

Description	Material	
	CS	SS
1. Body	SA216-WCB CS	SA351-CF8M SS
2. Elbow	SA216-WCB CS	SA351-CF8M SS
3. Isolation disc	17-4 SS	17-4 SS
4. Rotor	A351-CF8M SS	A351-CF8M SS
5. Index shaft	17-4 SS	17-4 SS
6. Indicator	A351-CF8M SS	A351-CF8M SS
7. Seat	A479-316 SS or A351-CF8M SS	A479-316 SS or A351-CF8M SS
8. Retraction bushing*	17-4 SS*	17-4 SS*
9. Process connection stud	SA193-B7 CS	SA193-B8M SS
10. Process connection nut	SA194-2H CS	SA194-8M SS

ANDERSON GREENWOOD SAFETY SELECTOR VALVE

TANDEM SAFETY SELECTOR VALVE

CONVENTIONAL METHOD

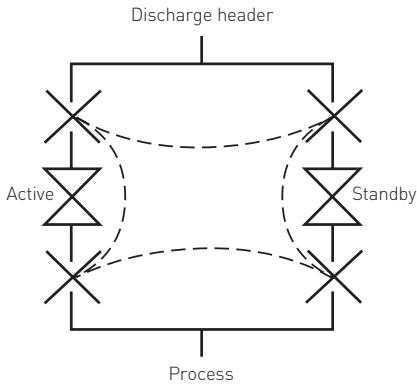

CUSTOMER FABRICATED

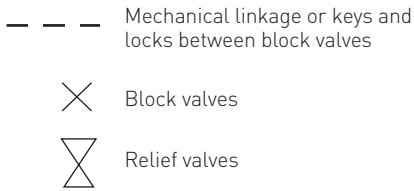

ANDERSON GREENWOOD TANDEM SAFETY SELECTOR VALVE

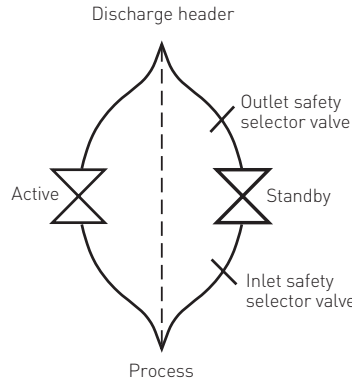

ANDERSON GREENWOOD FURNISHED

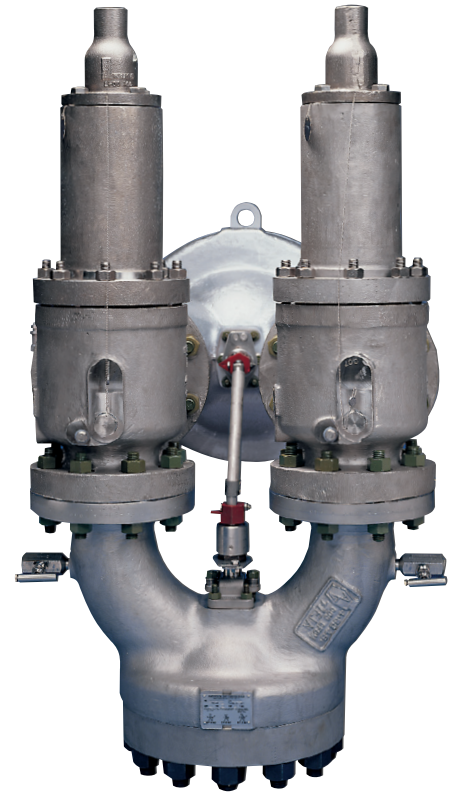
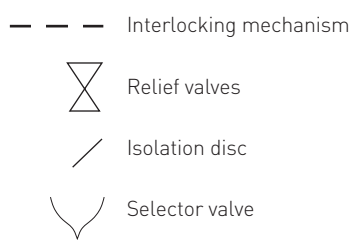

The tandem safety selector valve system enables simultaneous selection of pressure relief valve and corresponding discharge outlet piping of dual pressure relief devices discharging into a closed header system.

It provides a safer alternative to conventional redundant pressure relief device systems, which can be heavy and bulky, require significant field fabrication, installation time, expense and can be difficult and confusing to operating personnel.

With all of the inherent advantages of the standard safety selector valve, the two pressure relief valves, two safety selector valves and a simple linkage are pre-assembled at the factory. Only one flanged inlet and one flanged outlet connection are required to be made up in the field. The linkage between the inlet and outlet pressure relief valves is simple, foolproof and provides positive and simultaneous switching of the selector valves, ensuring overpressure protection is available 100% of the time.

ADVANTAGES

- Enhanced safety: eliminates accidental closure of a block valve either upstream or downstream of the intended active pressure relief valve.
- Compact and low weight.
- Lower installation costs with no field fabrication or multiple crane lifts required.
- Single, minimally sized penetration into vessel, single discharge header connection.
- Completely coordinated, tested and assembled package.
- Ease of engineering: no need for oversized piping and valves to prevent excessive pressure loss. Tandem safety selector valves are of the same line size as the pressure relief valve flanges.
- Less than 3% pressure drop to the pressure relief valve inlet when used with the largest API orifice available in a given valve size.

ANDERSON GREENWOOD SAFETY SELECTOR VALVE

DIMENSIONS AND WEIGHTS

SINGLE ACTIVE SAFETY SELECTOR VALVE

ANSI class	Dimensions and weights		1" (25)	1½" (40)	2" (50)	3" (80)	4" (100)	6" (150)	8" (200)*	10" (254)
150#	A	RF	11.11 (281)	12.07 (307)	11.70 (297)	13.26 (337)	16.13 (410)	20.17 (512)	24.69 (627)	30.25 (768)
	A	RTJ	11.11 (281)	12.26 (311)	11.89 (302)	13.45 (342)	16.32 (415)	20.37 (517)	24.88 (632)	30.25 (768)
	B		10.31 (262)	10.31 (262)	10.31 (262)	12.00 (305)	14.50 (368)	17.00 (432)	19.50 (495)	19.50 (495)
	(1)		18.73 (495)	19.50 (495)	19.50 (495)	22.44 (570)	26.06 (662)	32.13 (816)	36.97 (939)	40.75 (1035)
	(2)		52.00 (24)	122.00 (55)	115.00 (52)	169.00 (77)	267.00 (121)	594.00 (269)	989.00 (449)	1490.00 (676)
300#	A	RF	11.11 (281)	12.45 (316)	11.95 (304)	13.70 (348)	16.63 (422)	21.17 (538)	25.69 (653)	30.87 (784)
	A	RTJ	11.11 (281)	12.64 (321)	12.20 (310)	13.95 (354)	16.88 (429)	21.43 (544)	25.94 (659)	30.87 (784)
	B		10.31 (262)	10.31 (262)	10.31 (262)	12.00 (305)	14.50 (368)	17.00 (432)	19.50 (495)	19.50 (495)
	(1)		18.73 (495)	19.50 (495)	19.50 (495)	22.44 (570)	26.06 (662)	32.13 (816)	36.97 (939)	40.75 (1035)
	(2)		52.00 (24)	127.00 (58)	118.00 (54)	178.00 (81)	287.00 (130)	635.00 (288)	1043.00 (473)	1550.00 (703)
600#	A	RF	11.11 (281)	12.57 (319)	12.21 (310)	14.08 (358)	17.57 (446)	22.36 (568)	26.25 (667)	-
	A	RTJ	11.11 (281)	12.57 (319)	12.27 (312)	14.14 (359)	17.63 (448)	22.43 (570)	26.31 (668)	-
	B		10.31 (262)	10.31 (262)	10.31 (262)	12.00 (305)	14.50 (368)	17.00 (432)	19.50 (495)	-
	(1)		18.73 (495)	19.50 (495)	19.50 (495)	22.44 (570)	26.06 (662)	32.13 (816)	36.97 (939)	-
	(2)		52.00 (24)	129.00 (59)	122.00 (55)	184.00 (83)	311.00 (141)	699.00 (317)	1127.00 (511)	-
900#	A	RF	15.03 (381)	13.69 (348)	15.07 (383)	18.26 (464)	21.90 (556)	-	-	-
	A	RTJ	15.00 (381)	13.69 (348)	15.07 (383)	18.38 (467)	22.02 (559)	-	-	-
	B		12.00 (305)	12.00 (305)	12.00 (305)	12.00 (305)	14.50 (368)	-	-	-
	(1)		21.54 (547)	21.54 (547)	21.54 (547)	22.44 (570)	26.06 (662)	-	-	-
	(2)		153.00 (70)	155.00 (70)	174.00 (79)	235.00 (107)	381.00 (173)	-	-	-
1500#	A	RF	15.03 (381)	13.69 (348)	15.07 (383)	-	-	-	-	-
	A	RTJ	15.00 (381)	13.69 (348)	15.07 (383)	-	-	-	-	-
	B		12.00 (305)	12.00 (305)	12.00 (305)	-	-	-	-	-
	(1)		21.54 (547)	21.54 (547)	21.54 (547)	-	-	-	-	-
	(2)		153.00 (70)	155.00 (70)	174.00 (79)	-	-	-	-	-
2500#	A	RF	18.62 (473)	18.60 (472)	15.07 (383)	-	-	-	-	-
	A	RTJ	18.62 (473)	18.60 (472)	15.07 (383)	-	-	-	-	-
	B		12.00 (305)	12.00 (305)	12.00 (305)	-	-	-	-	-
	(1)		21.54 (547)	21.54 (547)	21.54 (547)	-	-	-	-	-
	(2)		173.00 (79)	205.00 (93)	195.00 (89)	-	-	-	-	-

* For Crosby brand JOS-E/JBS-E/JLT-E direct spring valves, refer to table below.

JOS-E/JBS-E - T AND T2 ORIFICE PRVS

ANSI class	Dimensions and weights		8" (200)
150#	A	RF	36.06 (916)
	A	RTJ	36.25 (921)
	B		23.50 (597)
	(1)		36.97 (939)
	(2)		1089.00 (494)
300#	A	RF	37.06 (941)
	A	RTJ	37.31 (948)
	B		23.50 (597)
	(1)		36.97 (939)
	(2)		1178.00 (534)

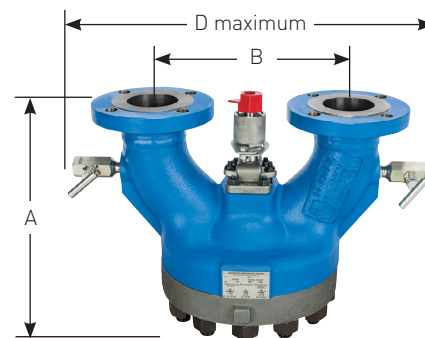

SINGLE ACTIVE SSV

NOTES

1. D maximum
2. Weight
3. D maximum dimension is for threaded hand valves.
4. Dimensions in inches
[] in millimeters.
Weights in pounds
[] in kilograms.
5. Dimensions listed are not applicable for the aluminum body material. Consult your sales representative for dimensions.

ANDERSON GREENWOOD SAFETY SELECTOR VALVE

DIMENSIONS AND WEIGHTS

TANDEM SAFETY SELECTOR VALVE WITH API 526 PILOT OPERATED PRVS

API orifice	Inlet by outlet size	Inlet flange		Outlet flange		Tandem SSV envelope Dimensions, inches (mm)	
		ANSI pressure class	Face type	ANSI pressure class	Face type	A	B
D/E/F	1 x 2	150	RF	150	RF	15.26 (387)	16.26 (413)
D/E/F	1 x 2	300	RF	150	RF	15.51 (394)	16.26 (413)
D/E/F	1 x 2	600	RF	150	RF	15.51 (394)	16.26 (413)
D/E/F	1 x 2	600	RJ	150	RF	15.61 (396)	16.26 (413)
D/E/F	1 x 2	900	RF	300	RF	20.00 (508)	20.98 (533)
D/E/F	1 x 2	900	RJ	300	RF	20.10 (510)	20.98 (533)
D/E/F	1 x 2	1500	RF	300	RF	20.00 (508)	20.98 (533)
D/E/F	1 x 2	1500	RJ	300	RF	20.10 (510)	20.98 (533)
D/E/F	1 x 2	2500	RF	300	RF	23.62 (600)	20.98 (533)
D/E/F	1 x 2	2500	RJ	300	RF	23.72 (602)	20.98 (533)
D/E/F	1½ x 2	150	RF	150	RF	17.01 (432)	16.51 (419)
D/E/F	1½ x 2	300	RF	150	RF	17.39 (442)	16.51 (419)
D/E/F	1½ x 2	600	RF	150	RF	17.51 (445)	16.51 (419)
D/E/F	1½ x 2	600	RJ	150	RF	17.61 (447)	16.51 (419)
D/E/F	1½ x 2	900	RF	300	RF	19.63 (498)	21.73 (552)
D/E/F	1½ x 2	900	RJ	300	RF	19.73 (501)	21.73 (552)
D/E/F	1½ x 2	1500	RF	300	RF	19.63 (498)	21.73 (552)
D/E/F	1½ x 2	1500	RJ	300	RF	19.73 (501)	21.73 (552)
D/E/F	1½ x 2	2500	RF	300	RF	24.54 (623)	21.73 (552)
D/E/F	1½ x 2	2500	RJ	300	RF	24.64 (626)	21.73 (552)
G/H	1½ x 3	150	RF	150	RF	17.26 (438)	22.42 (569)
G/H	1½ x 3	300	RF	150	RF	17.64 (448)	22.42 (569)
G/H	1½ x 3	600	RF	150	RF	17.76 (451)	22.42 (569)
G/H	1½ x 3	600	RJ	150	RF	17.86 (454)	22.42 (569)
G/H	1½ x 3	900	RF	300	RF	20.13 (511)	24.29 (617)
G/H	1½ x 3	900	RJ	300	RF	20.23 (514)	24.29 (617)
G/H	1½ x 3	1500	RF	300	RF	20.13 (511)	24.29 (617)
G/H	1½ x 3	1500	RJ	300	RF	20.23 (514)	24.29 (617)
G/H	1½ x 3	2500	RF	300	RF	25.04 (636)	20.51 (521)
G/H	1½ x 3	2500	RJ	300	RF	25.10 (637)	20.51 (521)

Continues on page 9

NOTE

1. Calculated using 1/16" thick gaskets for RF connections and the spacing listed in Table 5 of ANSI B16.5 for RJ connections.

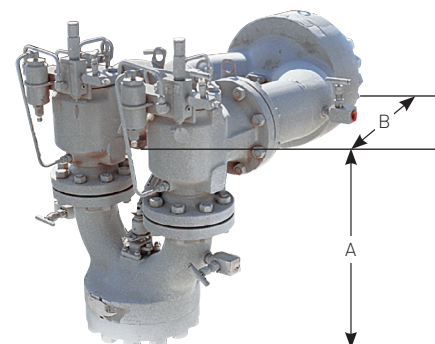

TANDEM SSV WITH PRVS

ANDERSON GREENWOOD SAFETY SELECTOR VALVE

DIMENSIONS AND WEIGHTS

TANDEM SAFETY SELECTOR VALVE WITH API 526 PILOT OPERATED PRVS

API orifice	Inlet by outlet size	Inlet flange		Outlet flange		Tandem SSV envelope Dimensions, inches (mm)	
		ANSI pressure class	Face type	ANSI pressure class	Face type	A	B
G/H/J	2 x 3	150	RF	150	RF	17.14 (435)	22.42 (569)
G/H/J	2 x 3	300	RF	150	RF	17.39 (442)	22.42 (569)
G/H/J	2 x 3	600	RF	150	RF	17.65 (448)	22.42 (569)
G/H/J	2 x 3	600	RJ	150	RF	17.84 (453)	22.42 (569)
G/H/J	2 x 3	900	RF	300	RF	21.69 (551)	24.29 (617)
G/H/J	2 x 3	900	RJ	300	RF	21.75 (553)	24.29 (617)
G/H/J	2 x 3	1500	RF	300	RF	21.69 (551)	20.51 (521)
G/H/J	2 x 3	1500	RJ	300	RF	21.75 (553)	20.51 (521)
G/H/J	2 x 3	2500	RF	300	RF	22.13 (562)	20.51 (521)
G/H/J	2 x 3	2500	RJ	300	RF	22.19 (564)	20.51 (521)
J/K/L	3 x 4	150	RF	150	RF	19.45 (494)	28.38 (721)
J/K/L	3 x 4	300	RF	150	RF	19.89 (505)	28.38 (721)
J/K/L	3 x 4	600	RF	150	RF	20.52 (521)	28.38 (721)
J/K/L	3 x 4	600	RJ	150	RF	14.33 (364)	28.38 (721)
J/K/L	3 x 4	900	RF	300	RF	25.82 (656)	29.63 (752)
J/K/L	3 x 4	900	RJ	300	RF	26.04 (661)	29.63 (752)
L/M/N/P	4 x 6	150	RF	150	RF	23.94 (608)	35.57 (904)
L/M/N/P	4 x 6	300	RF	150	RF	24.44 (621)	35.57 (904)
L/M/N/P	4 x 6	600	RF	150	RF	25.38 (645)	35.57 (904)
L/M/N/P	4 x 6	600	RJ	150	RF	25.57 (649)	35.57 (904)
L/M/N/P	4 x 6	900	RF	300	RF	31.77 (807)	37.51 (953)
L/M/N/P	4 x 6	900	RJ	300	RF	31.99 (813)	37.51 (953)
P	4 x 6	600	RF	150	RF	27.44 (697)	36.51 (927)
P	4 x 6	600	RJ	150	RF	27.63 (702)	36.51 (927)
Q/R	6 x 8	150	RF	150	RF	29.67 (754)	42.53 (1080)
Q/R	6 x 8	300	RF	150	RF	30.67 (779)	42.53 (1080)
Q/R	6 x 8	600	RF	150	RF	32.11 (816)	42.53 (1080)
Q/R	6 x 8	600	RJ	150	RF	32.31 (821)	42.53 (1080)
T	8 x 10	150	RF	150	RF	35.63 (905)	34.31 (871)
T	8 x 10	300	RF	150	RF	36.63 (930)	34.31 (871)
T	8 x 10	600	RF	150	RF	38.00 (965)	34.31 (871)
T	8 x 10	600	RJ	150	RF	38.19 (970)	34.31 (871)

NOTE

1. Calculated using 1/16" thick gaskets for RF connections and the spacing listed in Table 5 of ANSI B16.5 for RJ connections.

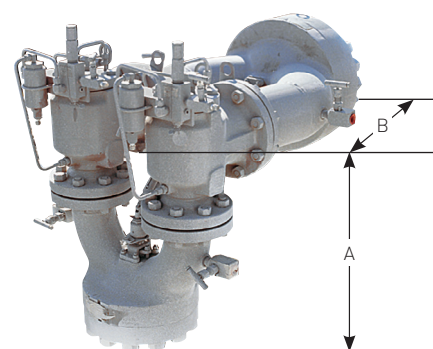

TANDEM SSV WITH PRVS

ANDERSON GREENWOOD SAFETY SELECTOR VALVE

DIMENSIONS AND WEIGHTS

TANDEM SAFETY SELECTOR VALVE WITH API 526 DIRECT SPRING OPERATED PRVS

API orifice	Inlet by outlet size	Inlet flange		Outlet flange		Tandem SSV envelope Dimensions, inches (mm)	
		ANSI pressure class	Face type	ANSI pressure class	Face type	A	B
D/E	1 x 2	150	RF	150	RF	15.26 (387)	16.26 (413)
D/E	1 x 2	300	RF	150	RF	15.26 (387)	16.26 (413)
D/E	1 x 2	600	RF	150	RF	15.26 (387)	16.26 (413)
D/E	1 x 2	600	RJ	150	RF	15.36 (390)	16.26 (413)
D/E	1½ x 2	900	RF	300	RF	17.88 (454)	21.73 (552)
D/E	1½ x 2	900	RJ	300	RF	17.98 (457)	21.73 (552)
D/E	1½ x 2	1500	RF	300	RF	17.88 (454)	21.73 (552)
D/E	1½ x 2	1500	RJ	300	RF	17.98 (457)	21.73 (552)
D/E/F	1½ x 3	2500	RF	300	RF	24.16 (614)	20.76 (527)
D/E/F	1½ x 3	2500	RJ	300	RF	24.22 (615)	20.76 (527)
E/F/G	1½ x 3	900	RF	300	RF	18.63 (473)	20.26 (515)
E/F/G	1½ x 3	900	RJ	300	RF	18.73 (476)	20.26 (515)
F	1½ x 2	150	RF	150	RF	17.01 (432)	16.51 (419)
F	1½ x 2	300LW	RF	150	RF	17.39 (442)	16.51 (419)
F	1½ x 2	300	RF	150	RF	17.39 (442)	17.76 (451)
F	1½ x 2	600	RF	150	RF	17.51 (445)	17.76 (451)
F	1½ x 2	600	RJ	150	RF	17.61 (447)	17.76 (451)
F	1½ x 3	1500	RF	300	RF	18.63 (473)	20.26 (515)
F	1½ x 3	1500	RJ	300	RF	18.73 (476)	20.26 (515)
G	1½ x 3	600	RF	150	RF	17.51 (445)	23.54 (598)
G	1½ x 3	600	RJ	150	RF	17.61 (447)	23.54 (598)
G	2 x 3	1500	RF	300	RF	21.26 (540)	20.51 (521)
G	2 x 3	1500	RJ	300	RF	21.32 (541)	20.51 (521)
G	2 x 3	2500	RF	300	RF	21.26 (540)	20.51 (521)
G	2 x 3	2500	RJ	300	RF	21.32 (541)	20.51 (521)
G/H	1½ x 3	150	RF	150	RF	17.01 (432)	22.29 (566)
G/H	1½ x 3	300LW	RF	150	RF	17.39 (442)	22.29 (566)
G/H	1½ x 3	300	RF	150	RF	17.39 (442)	23.54 (598)
H	2 x 3	300	RF	150	RF	17.14 (435)	22.42 (569)
H	2 x 3	600	RF	150	RF	18.33 (466)	23.92 (607)
H	2 x 3	600	RJ	150	RF	18.52 (470)	23.92 (607)
H	2 x 3	600	RF	150	RF	17.46 (444)	22.42 (570)
H	2 x 3	600	RJ	150	RF	17.59 (447)	22.42 (570)
H	2 x 3	900	RF	150	RF	21.19 (538)	19.70 (500)
H	2 x 3	900	RJ	150	RF	21.25 (540)	19.70 (500)
H	2 x 3	1500	RF	300	RF	21.26 (540)	20.14 (511)
H	2 x 3	1500	RJ	300	RF	21.32 (541)	20.14 (511)

Continues on page 11

NOTE

1. Calculated using 1/16" thick gaskets for RF connections and the spacing listed in Table 5 of ANSI B16.5 for RJ connections.

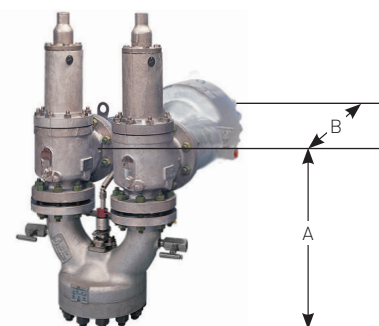

TANDEM SSV WITH DSOPRVs

ANDERSON GREENWOOD SAFETY SELECTOR VALVE

DIMENSIONS AND WEIGHTS

TANDEM SAFETY SELECTOR VALVE WITH API 526 DIRECT SPRING OPERATED PRVS

API orifice	Inlet by outlet size	Inlet flange		Outlet flange		Tandem SSV envelope Dimensions, inches (mm)	
		ANSI pressure class	Face type	ANSI pressure class	Face type	A	B
J	2 x 3	150	RF	150	RF	17.14 (435)	22.42 (569)
J	2 x 3	300LW	RF	150	RF	17.39 (442)	22.42 (569)
J	3 x 4	300	RF	150	RF	21.01 (534)	29.13 (740)
J	3 x 4	900	RF	150	RF	25.57 (649)	29.13 (740)
J	3 x 4	900	RJ	150	RF	25.79 (655)	29.13 (740)
J/K	3 x 4	600	RF	150	RF	21.39 (543)	29.13 (740)
J/K	3 x 4	600	RJ	150	RF	21.58 (548)	29.13 (740)
K	3 x 4	150	RF	150	RF	19.45 (494)	28.38 (721)
K	3 x 4	300	RF	150	RF	19.89 (505)	28.38 (721)
K	3 x 4	600	RF	150	RF	20.33 (516)	28.38 (721)
K	3 x 4	600	RJ	150	RF	20.45 (519)	28.38 (721)
L	3 x 4	150	RF	150	RF	19.45 (494)	28.50 (724)
L	3 x 4	300LW	RF	150	RF	19.89 (505)	28.50 (724)
L	4 x 6	300	RF	150	RF	23.75 (603)	34.45 (875)
L	4 x 6	600	RF	150	RF	24.69 (627)	35.32 (897)
L	4 x 6	600	RJ	150	RF	24.88 (632)	35.32 (897)
L	4 x 6	600	RF	150	RF	24.76 (629)	35.32 (897)
L	4 x 6	600	RJ	150	RF	24.95 (634)	35.32 (897)
L/M/N	4 x 6	900	RF	150	RF	29.71 (755)	36.07 (916)
L/M/N	4 x 6	900	RJ	150	RF	29.81 (757)	36.07 (916)
M	4 x 6	150	RF	150	RF	23.19 (589)	34.57 (878)
M	4 x 6	300	RF	150	RF	23.69 (602)	34.57 (878)
M	4 x 6	600	RF	150	RF	24.63 (626)	35.32 (897)
M	4 x 6	600	RJ	150	RF	24.82 (630)	35.32 (897)
N	4 x 6	150	RF	150	RF	23.94 (608)	35.57 (904)
N	4 x 6	300	RF	150	RF	24.44 (621)	35.57 (904)
N	4 x 6	600	RF	150	RF	25.38 (645)	36.07 (916)
N	4 x 6	600	RJ	150	RF	25.57 (649)	36.07 (916)
P	4 x 6	150	RF	150	RF	23.32 (592)	36.32 (923)
P	4 x 6	300	RF	150	RF	23.82 (605)	36.32 (923)
P	4 x 6	300	RF	150	RF	25.57 (649)	37.32 (948)
P	4 x 6	600	RF	150	RF	26.51 (673)	37.32 (948)
P	4 x 6	600	RJ	150	RF	26.70 (678)	37.32 (948)
P	4 x 6	900	RF	150	RF	30.84 (783)	37.32 (948)
P	4 x 6	900	RJ	150	RF	30.94 (786)	37.32 (948)
Q	6 x 8	600	RF	150	RF	31.86 (809)	42.53 (1080)
Q	6 x 8	600	RJ	150	RF	32.06 (814)	42.53 (1080)
Q/R	6 x 8	150	RF	150	RF	29.67 (754)	42.53 (1080)
Q/R	6 x 8	300	RF	150	RF	30.67 (779)	42.53 (1080)
T/T22	8 x 10	150	RF	150	RF	35.63 (905)	34.31 (871)

NOTES

1. Calculated using 1/16" thick gaskets for RF connections and the spacing listed in Table 5 of ANSI B16.5 for RJ connections.
2. Dimensions using Crosby JOS-E/JBS-E/JLT-E pressure relief valves. A = 47.30 (1201.42) B = 56.69 (1439.93) expanders are required on both the inlet and outlet Safety Selector Valves. Contact your sales representative for details.

ANDERSON GREENWOOD SAFETY SELECTOR VALVE

ORDERING INFORMATION

SELECTION GUIDE

Example:		SVR	08	12	F -	C	S	T	0	
Connection size										
04	1"									
06	1½"									
08	2"									
12	3"									
Pressure class										
05	ANSI 150									
10	ANSI 300									
12	ANSI 600									
Connection type										
F	Raised face flange (1" to 8")									
J	Ring joint flange (1" to 8")									
T	Threaded (1" to 3")									
X	Special									
B	Flat face flange (2"-10")									
Body material										
A	Aluminum	M	Monel®							
C	CS	N	Inconel®							
D	Duplex	S	SS							
H	Hastelloy®	X	Other (note type on order - contact your sales representative)							
Trim material										
S	SS	D	Duplex							
H	Hastelloy®	N	Inconel®							
M	Monel®	X	Other (contact your sales representative)							
Soft goods										
T	PTFE 400°F (200°C)									
G	Grafoil® 800°F (426°C)									
P	PEEK (with Grafoil® packing) 600°F (315°C)									
X	Special (contact your sales representative)									
Options										
0	Standard (inlet valve)									
T	Tandem (outlet valve)									
B	Built per ASME boiler and pressure vessel code section I, code case 2254 (see page 4)									
X	Special - note on order required options									

VCTDS-00241-EN © 2017, 2022 Emerson Electric Co. All rights reserved 09/22. Anderson Greenwood is a mark owned by one of the companies in the Emerson Automation Solutions business unit of Emerson Electric Co. The Emerson logo is a trademark and service mark of Emerson Electric Co. All other marks are the property of their prospective owners.

The contents of this publication are presented for informational purposes only, and while every effort has been made to ensure their accuracy, they are not to be construed as warranties or guarantees, express or implied, regarding the products or services described herein or their use or applicability. All sales are governed by our terms and conditions, which are available upon request. We reserve the right to modify or improve the designs or specifications of such products at any time without notice.

Emerson Electric Co. does not assume responsibility for the selection, use or maintenance of any product. Responsibility for proper selection, use and maintenance of any Emerson Electric Co. product remains solely with the purchaser.