

**Achieve more through
the power of partnership.**



Main Valve Partner™ for Nuclear Power

When you need to improve the flexibility, safety and reliability of your nuclear power plant, you can rest assured with Emerson as your Main Valve Partner



Extend your nuclear capability with a trusted Main Valve Partner.

These are dynamic times for the world's nuclear power operators and EPCs. As well as keeping your projects on schedule and on budget, you continually have to satisfy stringent international safety requirements, while addressing the demands of an increasingly complex industry.

There are new market issues too like the growing use of renewable energy sources. Nuclear reactors, in turn, are having to become more flexible by varying their output. What's more, the majority of nuclear plants that were originally designed for 40 years, are now being expanded to stay operational for up to 60 years or beyond.

The question is how can you manage and maintain your key assets to ensure they perform efficiently and safely over a longer life cycle? What happens if your valves become obsolete? Or if you just cannot find the highly skilled engineers you need to service them?

If only you had a single Main Valve Partner who could help you manage your control valves, critical isolation valves, pressure relief valves, regulators, actuators and instrumentation - so you can enhance efficiency through the lifetime of your projects.

“New nuclear builds are the most challenging infrastructure projects in the world”

- PWC



“The nuclear industry is experiencing a critical shortage of engineering and technological skills”

- Rullion Recruitment



“The global nuclear technology market is in a period of change, the likes of which have not been seen since nuclear plants were first deployed 50 years ago”

- World Nuclear News





“With total costs ranging from about \$6 billion to \$12 billion per unit and total project implantation times reaching up to a decade, building a nuclear power plant is one of the most complex of all industrial sector undertakings.”
-World Nuclear News

Emerson can help you generate long term success.

Emerson has been a mainstay of the nuclear industry since the first commercial nuclear power stations became operational more than 55 years ago. As such we have a unique understanding of the nuclear market's dynamics, technical complexities and on-going pressures to do more with less. We recognize how critical it is to keep a plant operating safely, effectively and economically. Which is why you can count on our long term support.

Managing the increase in project complexity

- With the broadest valve and actuator product portfolio and our deep experience, Emerson can be your Main Valve Partner
- We will help to keep your projects on schedule, within budget and compliant with all current regulatory requirements
- Our organizational structure enables us to capitalize on extensive worldwide experience, with engineering centers in USA, Germany, France and China
- We address resource constraints by sharing them at a global level, using same project management processes and tools

[Learn more ► P 5](#)

Ensuring your nuclear plant is compliant and safe

- Emerson provides the most complete portfolio of nuclear grade isolation, control and safety valves - from a single source
- Our valves have been installed in over 85% of nuclear plants worldwide.
- Our unique test capabilities, simulating actual operating conditions, confirm our products meet stringent requirements

[Learn more ► P 7](#)

Extending your product life cycle and improving plant performance

- Emerson delivers expert product support for the full lifecycle of your plant
- This expertise can help to extend the operational life of your plant, from its original 40 year life cycle to 60 years or beyond
- Our obsolescence management solutions enable us to propose alternative solutions where existing products are no longer available
- Our engineers can adapt and update products as required, helping you to improve the flexibility of your operation control and safety valves - from a single source

[Learn more ► P 9](#)





Increasing competitive demands, cost volatility and financial risk are spurring companies to improve project and asset management to get more value and cost savings from their portfolio of products.

“Since the time that most of today’s commercial nuclear power plants were built, the way projects are implemented, the supply chain, and particularly the financing environment, have all changed radically”

- **World Nuclear News**

“The nuclear industry has been under threat since the disaster at the Fukushima plant in Japan in 2011 revived concerns about safety”

- **Financial Times**

“The top priorities for EDF are safety, plant performance and long term operation”

- **EDF**

“There is a recent and increasing need for nuclear power plants to operate flexibly”

- **International Atomic Energy Agency**

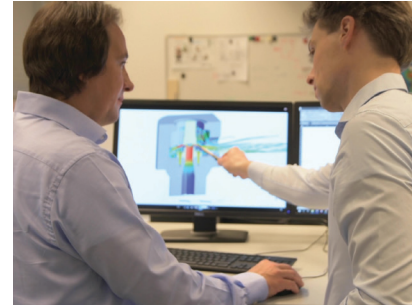

Expert project management support.

When it comes to managing the increasing complexity of projects, you need a Main Valve Partner who will be by your side for your plant's full 60 year lifecycle. A reliable partner that can deliver the total solution - combining the highest quality nuclear grade products with the project support skills, quality management and world class manufacturing capability you demand. A partner like Emerson.

Your single most sustainable partner

- Emerson has over 55 years experience supporting the nuclear industry
- We are the valve partner of choice for many global nuclear power generators
- Our large installed base is backed by a huge list of references
- You have one point of contact for all your nuclear grade valve requirements - simplifying your supplier relationships and saving you time

Supplying a comprehensive product portfolio

- Emerson offers one of the world's largest ranges of isolation, control and safety valves
- This means you will have the best custom engineered valve solutions - from a single source
- You can gain access to a host of recognized global brands for the nuclear industry such as Fisher, Sempell and Crosby

Delivering expert project management

- Emerson has the experienced skill base and multiple sites capable of providing expert project management dedicated to the nuclear industry.
- The multi-plant enterprise project execution provided from our plants operates with standardized global processes and tools
- Project management can allocate resources where they are available, preventing delays and bottlenecks

Backed by experienced engineering teams

Using advanced Computational Fluid Dynamics (CFD) and Finite Element Analysis (FEA) models, our engineers analyse complex geometries in valve designs to evaluate flow behaviour, locate stress concentrations and appreciate velocity distribution. For example, design modifications can be quickly implemented to minimize stress before prototyping or production try-outs.

Our worldwide organization focused on the nuclear industry, includes engineering centers in Germany, France, China and USA.

Using additive manufacturing to accelerate new product development

At Emerson we are committed to addressing our customers' engineering design challenges, while accelerating the speed to market of new and rigorously-tested products. Additive technologies allow us to broaden our design potential in order to solve more complex problems, in new ways. Design limits are pushed back, pilot production and testing are accelerated.



Products which deliver reliability and performance.

As the sector has undergone significant change, we have continued to pioneer, produce and deliver specialized valve solutions for all types of reactors, from our global manufacturing base, ensuring compliance with all international certification requirements and nuclear standards, with a high focus on reliability and performance.

Where quality comes as standard

- All nuclear components are supplied to ASME, RCC-M, KTA, or PNAEG standards
- Emerson factories and Q.A. procedures are inspected and audited regularly by major quality authorities including Lloyd Register, BSI, Bureau Veritas, TÜV and comply with ISO 9000:2000 or ISO 9001:2015

Video inspection process

Inspections are an important part of our process, ensuring all quality standards are met. This process is now easier due to the option of video inspection. Inspectors can view a variety of tests remotely:

- Live or recorded videos
- Photographs of some valve tests

This eliminates travel time and expense.

Qualification of nuclear safety related equipment

- No equipment leaves our factories unless we can demonstrate it has the capacity to fulfil its required function
- Emerson methods comply with qualification project requirements, codes and standards
- Test results and services engineers provide constant feedback enabling us to propose design improvements where required

Advanced manufacturing capabilities

World class machining

- CNC machining centers, including 5-axis centers
- Lifting capabilities of up to 20 tons
- Advanced lapping machines from FLP Microfinishing

State-of-the-art connection welding and surface cladding technologies

- Laser Welding
- Gas Metal-Arc welding (GMAW)
- Gas Tungsten-Arc welding (GTAW)
- Plasma Transfer-Arc welding (PTA) for the hard facing of valve seats with cobalt based and cobalt free alloys
- Submerged-Arc welding (SAW) for components up to 10 tons
- Orbital-welding equipment
- Welding robot system for hard facing

Unique test capabilities confirm reliability and performance

Using the broad range of capabilities at Emerson's disposal, our engineers rigorously analyse and test products to confirm they achieve the optimal reliability and performance. Our valves are tested with air, water or steam at conditions comparable to actual service conditions.

- Hydrostatic/proof of design stress testing
- Vibration testing
- Acoustic/vent testing
- Seismic pad testing
- Cycle/temperature testing
- Closed loop control performance testing

Setting new testing standards for control, isolation and safety valves

- Flow lines for valves up to NPS 36 and 240 bar (3,500 psig)
- A steam test facility for pressurizer safety relief valves, testing at the primary circuit steam conditions found in a PWR - up to 200 bar (2900 psi), 350°C (662°F) and producing 1ton of steam/h

The most advanced high flow steam test facility in the world

- Mansfield is the only valve manufacturer-owned facility capable of testing the Generation III PWR nuclear power plant MSSV under service conditions
- High Flow steam testing for isolation valves, testing pressures above 138 bar (2,000 psi) and saturated steam flow capacity of 900,000 kg/hr (2,000,000 lbs/hr)
- In addition, we can also simulate test environments outside of our labs, in order to qualify products to industry standards and beyond



Manufacturing and engineering centers	Main products	Certification
Korschenbroich, Germany	Sempell nuclear valves	RCC-M, KTA, PNAEG, ASME III-N Stamp, HAF604
Cernay, France	Fisher nuclear valves	RCC-M, ASME III-N Stamp, HAF604
Mansfield, USA	Crosby nuclear valves	ASME III-N Stamp, HAF604
Marshalltown, USA	Fisher nuclear valves	ASME III-N Stamp, HAF604
Armentieres, France	Nuclear valves	RCC-M, HAF604
Wuqing, China	Engineering center	

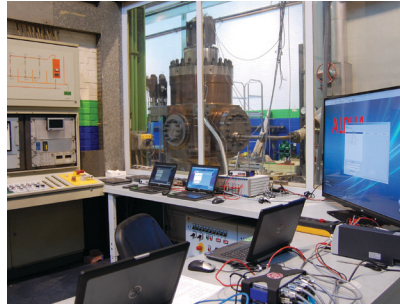
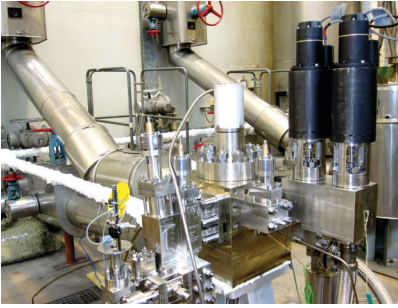

A partner for the full lifecycle of your plant.

With increased pressure for greater flexibility and the requirement to extend the operational life of plants our engineers will work with you to manage your assets getting more value and cost savings from your portfolio of products.

Obsolescence management

- Emerson will undertake to manage and maintain products for the full life cycle of your plant
- In addition, we can also provide alternative solutions for any products that are now obsolete
- Our obsolescence management enables continuous product updates/upgrades
- You will have ready access to commercial and classified parts

A highly skilled service organization

- Emerson understands that the nuclear industry is witnessing a serious skills shortage
- We can provide the dedicated and highly skilled service engineers the nuclear industry requires
- You can tap into our extensive experience and knowledge of global best practices
- Our service engineers are experts in the components being installed or commissioned, and can ensure correct, safe installation and on-time start-up

Stay informed with our diagnostic tools

- Emerson uses specialist diagnostic tools to check and analyze equipment quickly and safely
- Track and efficiently manage valve assets with tools like Sesi-Test, Flowscanner QL or SPVD, to determine when a valve needs reworking
- Ensure maintenance operations and ensure relevant tests are undertaken quickly to limit exposure to radiation (ALARA compliance)
- Gain easy access to all your valve data with End Of Manufacturing Report (EOMR) software
- Data can be compiled from multiple sources and centralized in 3 to 5 days



Emerson offers the complete valve solution for nuclear power generation.

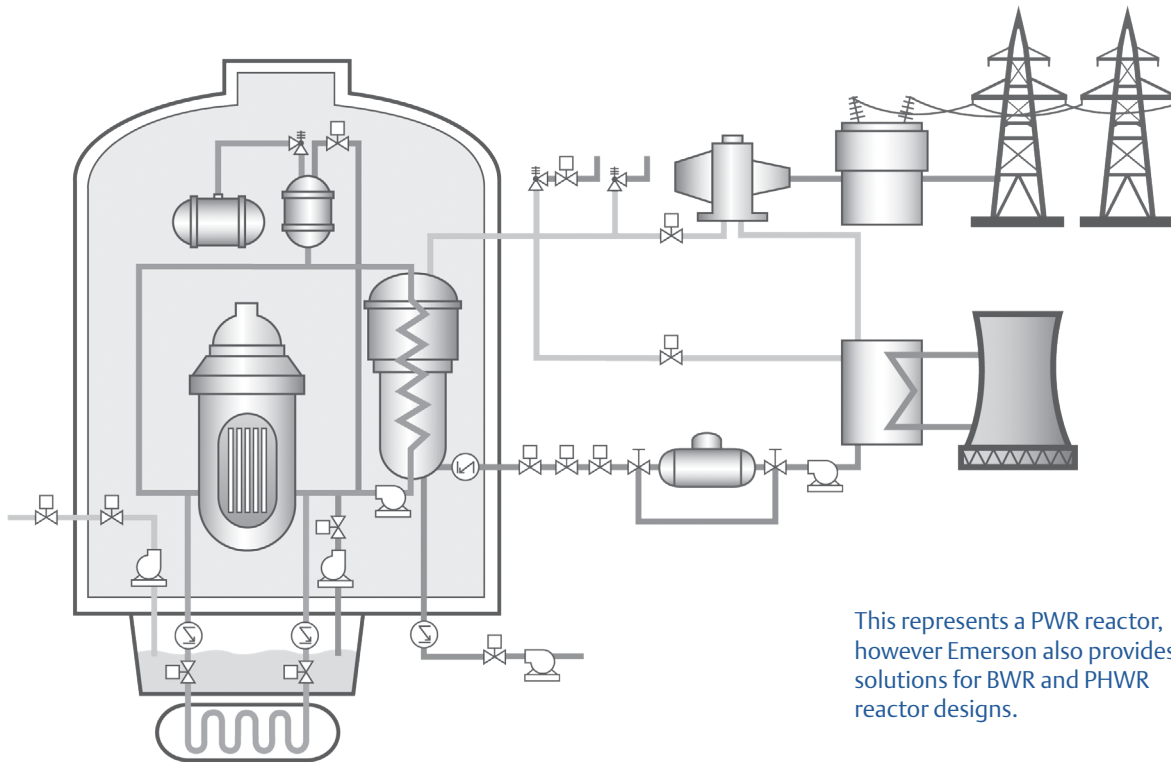

This represents a PWR reactor, however Emerson also provides solutions for BWR and PHWR reactor designs.

Primary circuit

- Spring loaded or pilot operated safety valves to protect the pressurizer
- High rangeability and easy to maintain spray valves, with control or on-off capabilities
- Severe accident depressurization valves

Core cooling system

- Control and isolation valves for Residual Heat Removal System (RHR)
- Control valves for Chemical & Volume Control System (CVCS)
- Check valves for safety injection system (SIS)
- Gate and check valves for the accumulator
- Medium operated isolation or spring-loaded safety valves for the Extra Borating System (EBS)

Auxiliary systems

- Control, isolation and relief valves for auxiliary circuits inside and outside containment
- Solutions for containment cooling, fire fighting, building ventilation, air/gas supply and waste treatment

Main steam system

- Specially designed steam dump control valves for steam discharge control with tight shut-off
- Fast acting gate and globe valves for fast and safe isolation of the main steam pipeline
- Spring loaded or pilot operated safety valves offering steam generator protection
- Main steam valve set, combining main steam isolation and safety valves in one compact valve unit

Feedwater system

(Nuclear and Conventional Islands)

- High performance feedwater control valves, with low friction and optimum sealing
- Globe, gate, swing and damped piston check valves for isolating the feedwater circuit and protecting pre-heaters

Turbine island

- Main steam turbine bypass valves and dump valves, with quick acting design, to support start-up, shutdown and load-follow operations
- Globe, check and gate valves to isolate main steam, drains system, moisture separator
- Relief valves and spring-loaded safety valves for overpressure protection

Instrumentation

- Smart instruments, positioners and regulators to provide highly accurate positioning in harsh environments and embedded diagnostic capabilities
- Inside and outside containment



Primary circuit

The pressurizer compensates for any fluid volume expansion that may occur during normal and abnormal operations. Emerson's safety valves protect the pressurizer against overpressure, with extensive availability and qualification.

[Learn more ▶ P 13](#)

Core cooling system

The core cooling system adjusts the reactor power level. In the event of a problem, rapid management is required to stop a chain reaction. Which means control valves and isolation valves have to react quickly and with extreme reliability. [Learn more ▶ P 21](#)

Auxiliary systems

Containment buildings, as well as the balance of plant, integrate many auxiliary circuits. These manage systems such as the ventilation, air supply and waste treatments, which require classified and non-classified valves for fluid flows. [Learn more ▶ P 25](#)

Main steam system

The purpose of the main steam system is to provide steam to the turbine. This requires control, isolation and safety valves to prevent any overpressure of the steam source and overcooling of the reactor coolant system.

[Learn more ▶ P 29](#)

Feedwater system (nuclear and conventional islands)

The Emerson valves used in feedwater systems provide extreme reliability to prevent a reactor trip.

[Learn more ▶ P 33](#)

Turbine island

Quick acting valves help to protect the turbine during normal operating modes, transient conditions and worst-case failure conditions. [Learn more ▶ P 37](#)

Instrumentation

Classified and non-classified smart instrumentation, positioner and regulators provide highly accurate positioning and diagnostics. [Learn more ▶ P 41](#)

Primary Circuit.

Emerson safety valves protect the primary circuit against overpressure. Our Pressurizer Safety Relief Valves (PSRV) are system-medium operated safety valves and are adapted to the specific reactor design by using a dedicated range of pilot valves. Extensive qualification programs, addressing Anticipated Transients Without Scram (ATWS) conditions, 'Feed and Bleed' and 'cold' overpressure protection, support the most secured solutions.

Our valves have already accumulated over a hundred years of combined service in Gen II power stations and Emerson was chosen for almost all Gen III reactors. When it comes to dealing with Safety Class 1, we have the qualified solution.

What's your opportunity?

- One Main Valve Partner offering highly qualified products and valve packages
- Our pressurizer safety valves are qualified, on full scale for discharge of steam, water and water-steam mixture
- Their compact design offers stable operation, high reserve forces for opening and closing, excellent accuracy and repeatability
- More than 85% of nuclear units in operation rely on Fisher spray control valves, using a unique design
- Our products are designed for service engineers who are exposed to ionizing radiations, with integration from ALARA principles

Secure your project with qualified technology

Emerson's engineers have designed and qualified optimized valve packages for US AP1000, Korean APR1400, European EPR and Russian VVER, ensuring nuclear power plants across the globe have the safest solutions. As our valves are already qualified for all Gen III reactors, we can help to secure your projects against the time and cost constraints of qualification going forwards.

Services offered

- Global and local support during installation, commissioning and start-up phases
- Services and application training
- Diagnostic solutions for conditional approach
- Maintenance programs

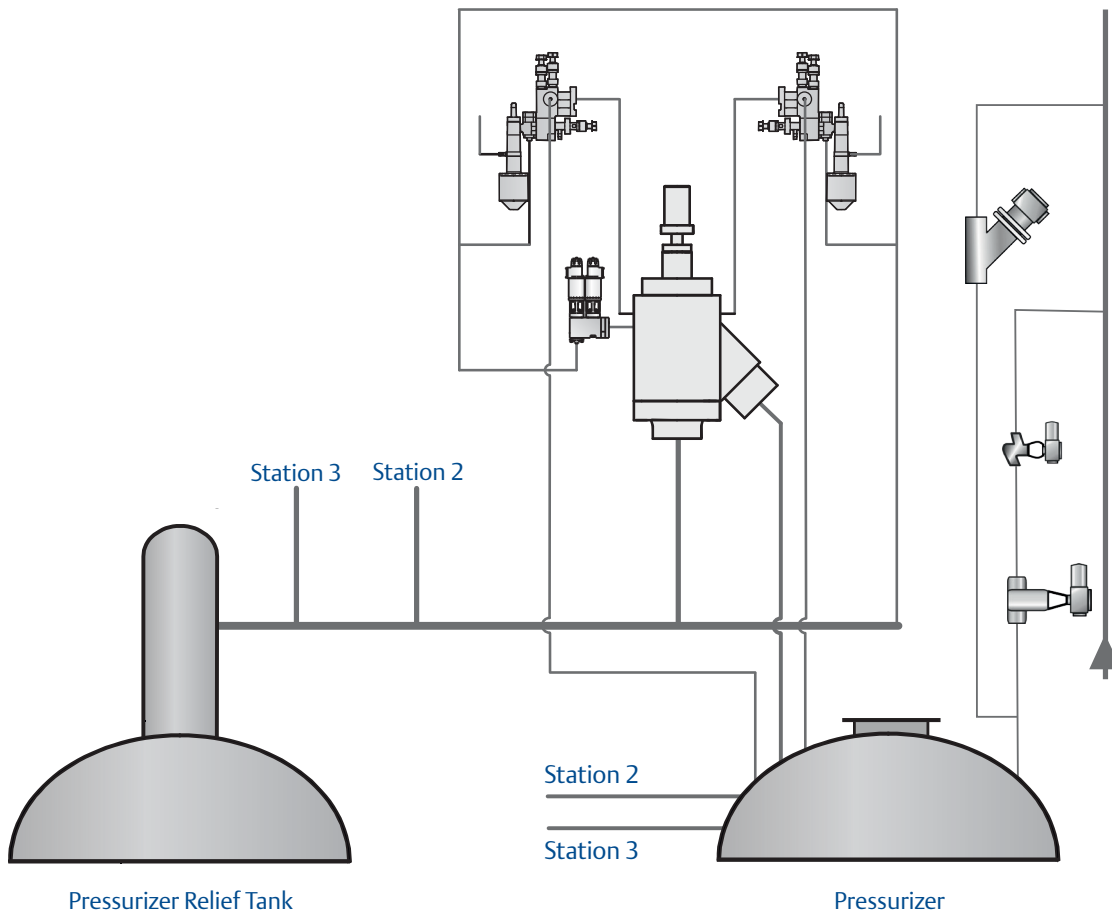

Spray Valves

Air-operated control valves Fisher™ - SS84PSV4, 1052PSV

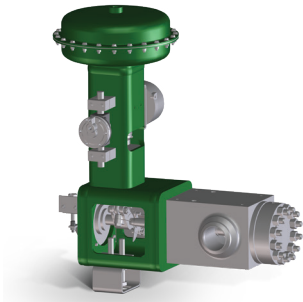

Ball control valve with high flow accuracy and live-loaded packing, installed on most PWR Nuclear Power Stations since 1970's.

- Compliant with NPP Generation 3 with dedicated qualification programs
- Body/Actuator connection designed and tested for Seismic Compliance
- ASME / RCCM Class 1
- Long Life Vee-Ball internal trim, operating against a spring-loaded sleeve seal
- Easy trim maintenance with large access compliant with ALARA guidelines

Solenoid operated - modulating control valve Type 607^(*)



Emerson uses third party technology for a modulating solenoid valve in response to the plant's flow control command. This technology consists of a pilot-operated solenoid valve, a LVDT for position indication, and a proprietary electronic positioner to create a closed feedback loop. It is particularly well suited where a pneumatic supply, required for traditional control valves, cannot be provided.

- Size: NPS 3-4 / DN 75-100
- Pressure class: 1600 / PN 175
- RCC-M Class 1 for mechanical and RCC-E for electrical

Spray Valves

Solenoid operated - on/off valves Sempell SV



Solenoid-controlled spray valves ensuring opening or closing in accordance with the coolant pressure, closed during normal operation. The valve has a small borehole in the valve disc to keep the spray lines and the volume compensation line at a given temperature with a continuous flow rate.

- Size: NPS 3 / DN 80
- Pressure class: 1500/PN250
- Body material: 1.4553/1.4541, A182 F316 LN (1.4406)

E-motor operated valves Sempell - ZBS 5



Bellows-sealed, Z-form forged body, high quality material, cobalt free hard facing at seat, disc and guiding surfaces. Different control characteristics available, permanent flow over throttle in the valve disc to keep the spray lines and the volume compensation line at a given temperature.

- Size: up to NPS 4/DN100
- Pressure class: 1500/PN250
- Body material: 1.4553/1.4541, A182 F316 LN (1.4406)

Pressurizer Safety Relief Valves (PSRV) for EPR

Three main valves, type VS99, are mounted directly to the side of the pressurizer with an inlet angled at 45°, enabling the valves to be vertical. A permanent water loop fills the main and pilot valves, so during blow down purely sub-cooled water will be relieved first. Two pilot valves, type Sierion, are on each main valve. This is a non-floating steam pilot valve which performs well with different media conditions including pure steam, water, 2-phase-mixture and subcooled water.

Stop valves are located between the main and pilot valves for the impulse and control lines. Only one pilot valve is active at a time. Typically, a double solenoid valve, type DMS, is used as a bleed and feed valve.

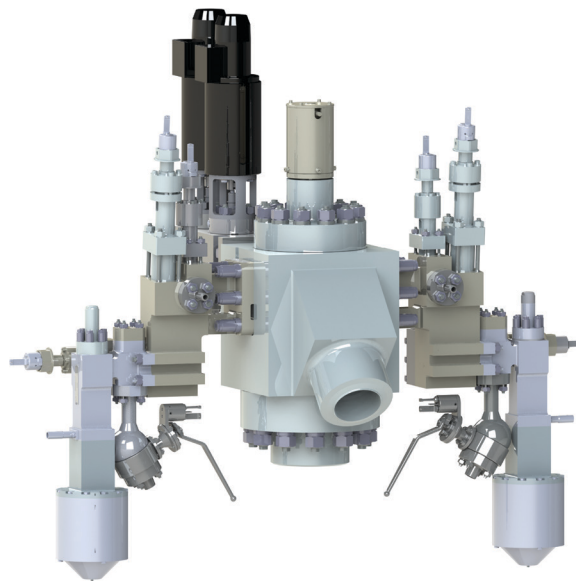

Main pressurizer safety relief valves

Sempell - VS99

Block-design with direct, horizontally mounted pilot valves.

- References: Europe, China
- Size: NPS 4 & 6/DN 100 & 150
- Pressure class: 1500/PN 250
- Body material: Z2 CN 19-10 N2
- Qualification: Qualified by Areva/Framatome for EPR

Pilot valves

Sempell - SIERION

Non-floating design.

- References: Europe, China
- Size: NPS 1/DN 25
- Pressure class: 1500/PN 250
- Body material: Z2 CN 19-10 N2
- Design owned by Areva/Framatome. Manufactured under design control of Areva/Framatome
- Qualification: Qualified for EPR

Bleed & feed valves

Sempell - DMS 6

Double solenoid pilot valve with a forged one-piece body and two valves that alternate for testing during operation.

- Size: NPS 1½ / DN 32
- Pressure class: 1500 / PN 250
- Body material: Z2 CN 19 - 10 N2
- Qualification: Full scale tested, together with the main valve. Qualified by Areva/Framatome for EPR

Pressurizer Safety Relief Valves (PSRV) for APR 1400

Four main valves type VS99, are welded directly on top of the pressurizer horizontally for optimized pipe conduction. Two self-acting pilot valves, type VS66, per main valve are used redundantly, enabling the impulse and control lines to be locked by integrated stop valves. They are connected to the system pressure by independent feeding lines within the main valve body, producing a compact design. A double motor valve, type PDE, is installed for opening below set pressure.

The design received the NV stamp and the valve station is qualified for steam, two-phase-flow and subcooled water media operation.

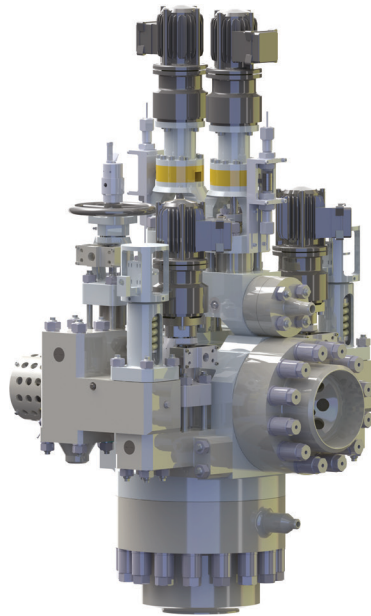

Main pressurizer safety relief valves Sempell - VS99

Block-design with direct, horizontally mounted pilot valves.

- References: South Korea, United Arab Emirates
- Size: NPS 8 / DN 200
- Pressure class: up to 2500/PN 400
- Body material: A182 F316 LN (1.4406)
- Qualification: Flow coefficient by NB, USA - Function by Areva, Karlstein with steam, water and two-phase mixture, ASME QME-1

Spring loaded pilot valves Sempell - VS66

Floating design.

- References: South Korea, United Arab Emirates
- Size: NPS 1 / DN 25
- Pressure class: up to 2500 / PN 400
- Body material: A182 F316 LN (1.4406)
- Qualification: ASME III NV (together with VS99). Stable performance when subjected to two-phase flow; no costly loop seal required.

Bleed & feed valves Sempell - DPDE

Motor operated pilot valve with integrated isolation valve in one forged body.

- Reference: South Korea, United Arab Emirates
- Size: NPS 1/DN 25
- Pressure: up to class 2500/PN 400
- Body material: A182 F316 LN (1.4406)
- Qualification: ASME III NV (together with VS99)

Pressurizer Safety Relief Valves (PSRV) for VVER

The pressurizer is equipped with three independent safety valves which are installed in parallel on a steam collector pipeline. Two spring-loaded pilot valves, type VS66, are located on each main valve. The VS66 pilot valves are connected to the system pressure by independent feeding lines within the main valve body. Should the solenoids not switch off, the pilot valves operate as self-acting spring-loaded safety valves. No external energy is needed.

The VS99 is equipped with a separate impulse line actuated by a remote-controlled solenoid valve, type VCA. The valves are qualified for operation of steam, two-phase-flow and subcooled water.

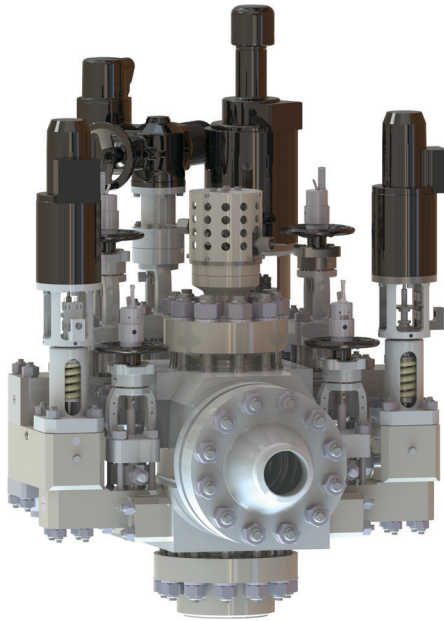

Main pressurizer safety relief valves Sempell - VS99

Block-design with direct mounted pilot valve. The body is angular with a lateral inlet nozzle and vertical downward outlet nozzle.

- References: PWR Germany and Brazil, PWR (VVER)
- Size: up to NPS 8 / DN 200
- Pressure class: 1500 / PN 250
- Body material: 1.4553 / 1.4541
- Qualification: Areva laboratory Erlangen with steam, water and two-phase mixture and Karlstein, for compact design see APR1400 qualification

Spring loaded pilot valves Sempell - VS66

Floating design. These valves are equipped with a solenoid that provides supplementary seat tightness forces and assists opening and closing.

- References: PWR Germany and Brazil, PWR (VVER)
- Size: NPS 1/DN 25
- Pressure class: 1500/PN 250
- Body material: 1.4553/1.4541
- Qualification together with VS99, stable valve performance when subjected to two-phase flow; no costly loop seal required

Bleed & feed valves Sempell - VCA

Energized open solenoid valve with integrated isolation valve in one forged body.

- References: PWR Germany, PWR (VVER)
- Size: NPS 1/DN 25
- Pressure class: 1500/PN 250
- Body material: 1.4553/1.4541
- Qualification: Together with VS99

Pressurizer Safety Relief Valves (PSRV) for AP1000 and SMR

The Crosby style HB-BP-86 direct spring-loaded pressurizer safety valve has been designed for the exacting service and operating requirements of the Pressurizer Safety Valve application in PWRs worldwide. Equipped with the latest designed flexi-disc seat technology, the style HB-BP-86 safety valve provides precise operation and field proven seat tightness which allows operating pressures close to valve set pressure without leakage across the valve seat.



Size & Selection

Inlet Sizes: 1 - 8 NPS (DN 25 - 200)
Outlet Sizes: 2 - 10 NPS (DN 50 - 250)
Qualification:
ASME Section III Class NB
Seismic & environmentally qualified
to ASME QME-1

Bellows

The bellows balances out the effects of high backpressure in the discharge system, assuring constant popping pressure despite variable backpressure.

Eductor

Crosby's unique patented Eductor control permits the valve to attain full capacity lift at a pressure 3% above popping pressure to the requirements of Section III of the ASME Boiler and Pressure Vessel Code.

Safety limit switch

Model C7 IEEE qualified Class 1E, safety related switch with EGS quick disconnect from Emerson TopWorx
Qualification Standards:
IEEE 382-1996, IEEE 572-1985,
IEEE 323-2003, IEEE 344-2004,
IEEE 383-2003.

Spring Loaded Safety Valves (NSSS)

Auxiliary relief valves (NSSS) Crosby - OMNI 900 Series

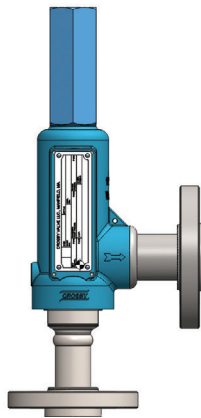

Conventional safety relief valve designed for use on steam, air, gas and liquid service. Its single trim design provides stable operation on all service media.

- Inlet Sizes: ½ - 2 in (DN 15-50),
- Outlet Sizes: 1 - 2½ in (DN 25-65)
- Connection: Flanged, threaded and welded
- Capacity Certified: NB - 18
- Qualification: ASME Section III Class 1, 2 & 3; seismic/ environmentally qualified to ASME QME-1

Spring-loaded pilot valves Crosby - J-Series



A range of direct spring-operated safety valves for steam, air and liquid applications. A single nozzle ring control provides optimum performance.

- Dampener available for multiple transient application
- Forged body construction with flanged and welded connections
- Balancing bellows available for radioactive fluids
- Inlet Sizes: 1 - 8 in (DN 25-200)
- Outlet Sizes: 2 - 10 in (DN 50-250)
- Qualification: 1:1 with accidental conditions; ASME Section III Class 1, 2 & 3 and RCC-M up to level 2

Spring Loaded Safety Valves (NSSS)

Spring-loaded safety valves for thermal expansion Sempell, Mini S - VSE0



Pop action valves designed for gas and steam service. Threaded or flanged forged blow-off body design.

- References: Germany, Sweden, Finland
- Size: NPS ½ - 2 / DN 15 - 50
- Pressure class: Mini S: 150-300 / PN20-64; VSE0: 150-2500 / PN20-420
- Qualification: ASME VIII and VdTUV type-tested

Severe Accident Valves

Gate and globe valves Sempell GPS5X, ESS1X

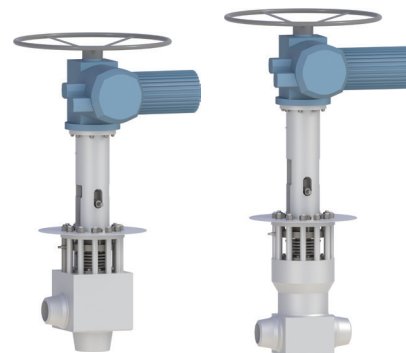

Electric-motor operated Gate and Globe valves for severe accident mode, capable to open at parameters up to 600 °C with a deltaP of up to 190 bars and able to stay open with pressurizer gas temperature up to 1200 °C. In addition, the valves are operable in the feed and bleed conditions.

- Size: NPS 6/DN 150
- Body material: Z2 CN 19-10 N2
- Actuation time: < 60 seconds
- Media: water, subcooled water, mixture of superheated steam, saturated steam, saturated water, hydrogen and aerosols

Flow Chemical Treatment

High pressure globe valves - Gen III Fisher™ - HPNS and HPANS, 667NS2



Globe straight or angle style valves with live loaded graphite packing and a seismic bonnet on a designated piston or air operated actuator. Installed in EPR and AP1000 Nuclear plants.

- Bi-directional anti-extrusion seal trim, available with characterized flow cages
- HPNS available with bore seal trim: for high temperature applications and Cavitrol or Whisper Trim options, Class V shutoff
- HPAS available with DST trim: incorporates a protected seating feature, ensuring long-lasting, tight shutoff
- Multi-stage service anti-cavitation trim, suitable for the harshest conditions

Flow Chemical Treatment

High pressure globe valves Fisher - DBQNS



Valves with live-loaded packing and seismic design. They can be equipped either with manual air-operated or electric actuators. Installed in most Generation 2 and 3 nuclear power stations, this design may be used in general high pressure/temperature fluid control applications with multiple trim combinations.

- Size: NPS 1-3 / DN 25-80
- Long Trim life: cage, valve plug and seat ring are manufactured in hardened materials to provide excellent wear resistance
- Easy maintenance: periodic trim inspection only requires some minutes
- Valve plug stability, reducing vibration and mechanical noise



Core cooling system.

The core cooling system is expected to provide assured fuel cooling, following a reactor shutdown or a loss-of-coolant accident (LOCA), and must therefore maintain the highest levels of performance and reliability. To help you achieve this, Emerson's specialized check and gate valves will support dependable isolation, both during the switchovers between different circulation modes and normal operation. Or you can use spring loaded safety valves to deliver an extra borating system.

We also recognize that large pressure drops and cavitation issues can have a significant impact on a core cooling system, particularly on the injection and charging flow functions in transient mode.

What's your opportunity?

- You have products that are designed specifically to address FME safety concerns
- Benefit from a prognostic services solution that uses diagnostic tools to reduce the amount of maintenance required during shut-downs on control valves

The plug and play approach to uncompromising safety

Emerson's control valves use plug and play solutions, which allow you to extend the durability of internal parts, reduce maintenance windows during shut-downs and prevent any foreign material intruding into radioactive circuits.

These are complemented by check and gate valves that are specifically designed and configured for the requirements of the core cooling system.

Services offered

- Global and local support during commissioning, start-up and post start-up phases
- Services and application training
- Diagnostic solutions for preventative maintenance
- Plug and play internal parts for radiation exposure time
- Human factor integration in product design

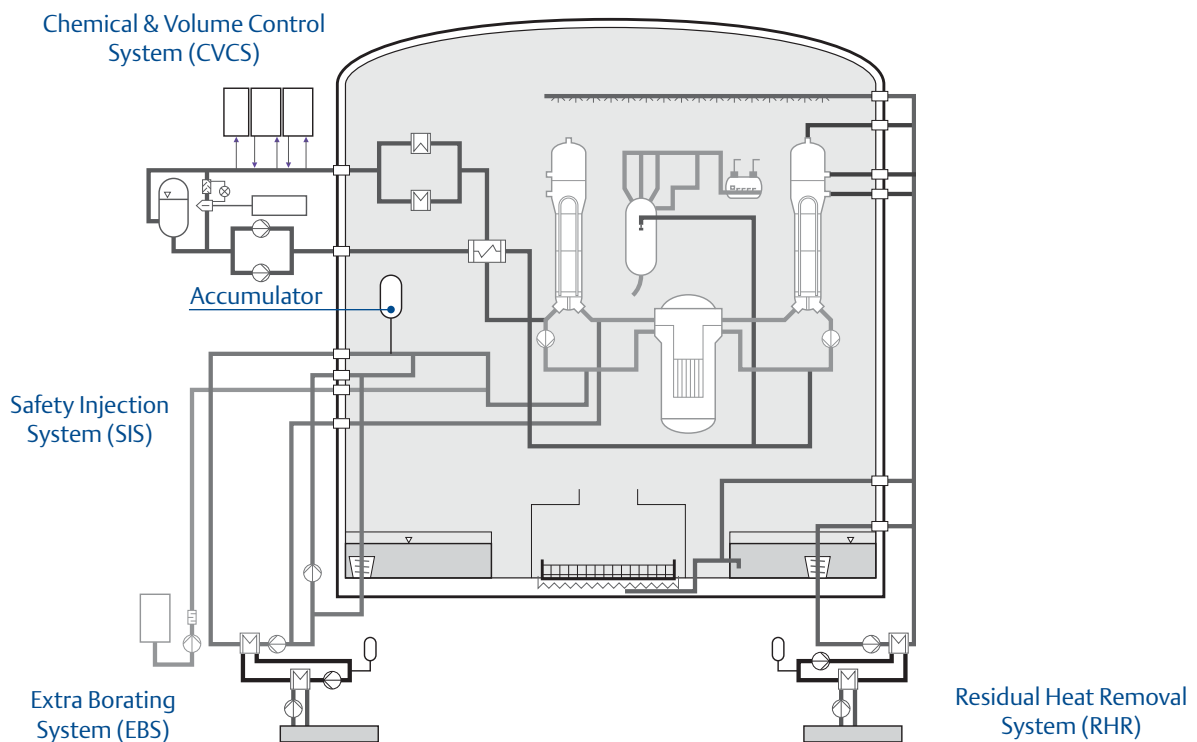

Residual Heat Removal System (RHR)

Butterfly control valves Fisher - 7600, 1052



Used for general control applications, where extremely low leakage rates are not required.

- Heavy-duty construction and swing through disk (which does not contact the valve body)
- The body is suitable for high inlet pressures and high pressure drops over a wide temperature range
- Excellent flow control - Fishtail™ disk exhibits approximately an equal percentage flow characteristic through a full 90° of disk rotation
- Size: NPS 8-16 / DN 200-400

Vee-Ball™ valves Fisher - SS-264

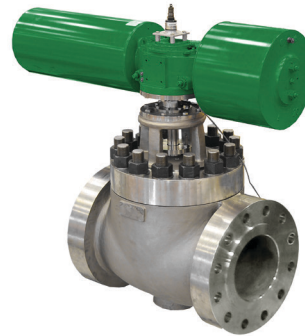

This valve, with a piston actuator, is specifically engineered for Westinghouse AP1000, including heat removal applications.

- 14" Class 1500 butt weld stainless steel ball valve
- 316L hardened construction
- Achieves class IV shutoff with dynamic seat live loaded graphite packing
- Bettis G4120 SR3 spring return actuator: with specific seismic nuclear adaptations and Fail Open
- Size: NPS 14 / DN 350

Chemical & Volume Control System (CVCS)

Globe straight or angle design valves Fisher - EV, EVNS



A variety of drop-in trims makes the easy-e™ globe valves ideal for balanced, unbalanced and tight shutoff applications, as well as other high temperature and severe service uses. Also available with micro-flow trims.

- Live-loaded packing up to bellows seal construction
- Standard drop-in cages or tailor-made characteristics
- Balanced valve plugs reduce the required stem force
- High rangeability
- Size: NPS 1-10 / DN 25-250

Safety Injection System

Check valves Sempell - EBS51, EBS55

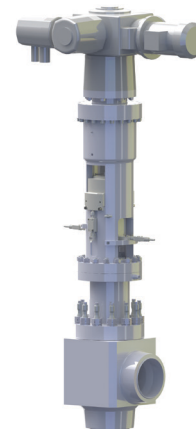

Screw down and lift check valves with a one-block design. Enables a switch over between safety injection pump circuits and circulating operation, with RHR pumps and residual heat exchanger following LOCA.

- References: PWR, PWR (VVER) Slovakia
- Pressure class: 1500 / PN 250
- Body material: Stainless steel
- Size: up to NPS 12 / DN 300

Accumulator

Swing check valves Sempell - HKS5

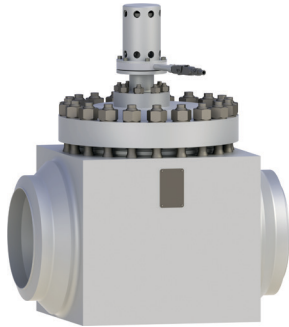

A swing check valve suitable for steam and water with a one-piece block-design. A special retaining ring assembly enables precise flap positioning. The lack of a shaft duct excludes leakages to the outside and ensures the function is not impaired by friction in the glands.

- References: BWR, BWR, PWR (VVER), Russia, China, Ukraine, Czech Republic, Slovakia
- Size: up to NPS 18 / DN 450
- Pressure class: 1500 / PN 250
- Body material: A105 (1.0460) and SS
- Qualification: seismic test at Sempell laboratory

Blow-down isolation gate valves Sempell - GPS5, GPS5+



Designed for steam and water circuits operable at guillotine pipe-break and after electric actuator switch-off failure. Split wedge design delivers superior leak tightness.

- Precise wedge guiding and D-shaped wedges avoid tilting effects
- References: Germany, Sweden, Finland
- Size: up to NPS 24 / DN 600
- Pressure class: up to 2500 / PN 400
- Body material: forged CS and SS
- Stellite and cobalt free hardfacing
- Qualification: tests at GAP Karlstein

Extra Borating System (EBS)

Media operated gate valves Sempell - GPS50



Self-media operated, this fast opening wedge gate valve provides low pressure loss and redundant pilot valve configuration.

- References: Finland, China
- Fast opening within 5 seconds
- No wedge - seat contact during stroke
- Size: NPS 6 / DN 150
- Pressure class: up to 1500 / PN 250
- Body material: different stainless-steel nuclear grades
- Qualification: Sempell laboratory

Classified spring-loaded safety valves (NSSS) Crosby - J-Series



A range of direct spring-operated safety valves for liquid applications.

- Forged body construction
- Dampener available for multiple transient applications
- References: PWR
- Size: up to NPS 6 / DN 150
- Pressure class: up to 1500 / PN250
- ASME or RCC-M up to level 2



Auxiliary systems.

With such a diverse range of auxiliary systems located inside every nuclear plant, Emerson has a variety of qualified and non-qualified products to meet your requirements and improve operational efficiency. This includes global asset management service dedicated to rotary valves, globe valves, gate valves, safety-relief valves and regulators.

What's your opportunity?

- Rely on our simple and robust valve design, that only has two parts in contact with the fluid to limit and facilitate maintenance
- Use 3-way valves which provide diverging and converging solutions
- Achieve extreme low-flow sampling for fine chemical loops
- Support tight shut-off packing through use of bellows-sealed constructions

Emerson's on-going drive for flexibility never stops

Emerson's 3-way Fisher control valves offer nuclear operators a flexible, value-added solution. Cage guided with flow modulation, they possess a larger CV capacity than other comparable valves. Our safety valves are incredibly adaptable too and can fit both normal and accident operation modes. And while low sampling applications have become a key focus for the industry, Emerson is leading the way in solving the challenge on Generation III.

Services offered

- Global and local support during commissioning, start-up and post start-up phases
- Services and application training
- A special long life construction, used on sampling applications, helps to limit mechanical inspections to 10-year intervals
- Spare parts references by unique inter-changeability grids designed for nuclear compliance

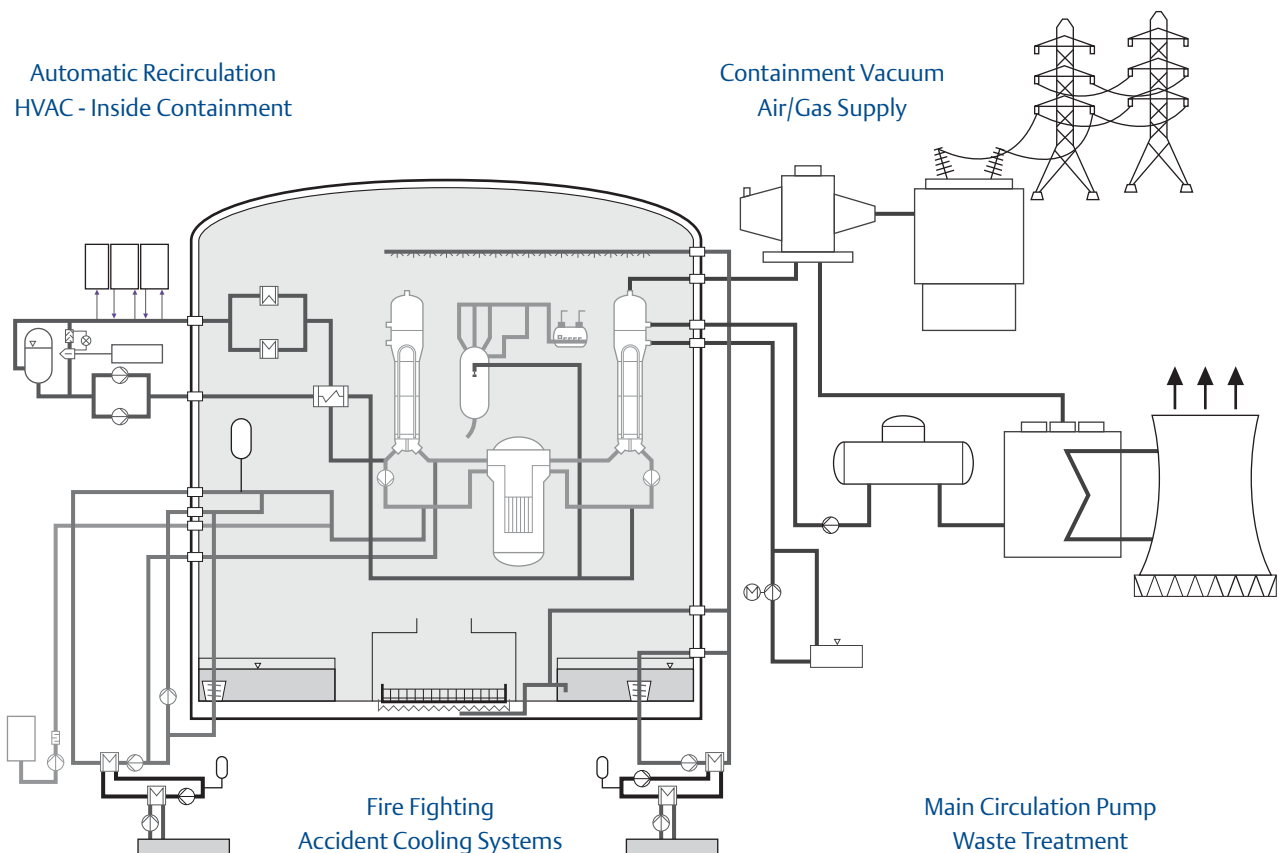

Control Valves

3 way valves Fisher - YV, NS



These 3-way valves have a sliding stem translation and can be adapted to mixing control applications, using a convergent or divergent design with a higher Cv.

- Flanged connections or butt-welding
- Metal-metal contact between the body and bonnet, plus oversized bolting, enable full compliance with seismic requirements
- Available with cage or plug guided internal parts
- Size: NPS 1-16 / DN 25-400

Vee-Ball valves Fisher - V300



V300 Vee-Ball valves have a shearing action between the V-notch ball and the ball seal promotes a smooth, non-clogging operation. Unrestricted straight-through flow design provides high capacity for gas, steam, liquids.

- Integral flow capacity and high rangeability
- The splined drive shaft can combine with a variety of power operated and manual actuators
- Providing high-performance throttling or on-off operation
- Size: NPS 3-6 / DN 80-150

General Applications

Stop and check valves Sempell - NICO 4000



High pressure stop and check valves with supporting springs and cobalt free hard facing.

- Used in all steam and water systems
- Die-forged 1-piece body or 2-piece body with bellows
- Prepared with either electric or pneumatic actuators and a broad range of accessories
- Size: NPS ½ - 2 / DN 15 - 50
- Pressure class: 2500 / PN 420
- Body material: A 105, A182 F 347
- Qualification: type tested

Blow-down isolation gate valves Sempell - GPS 5

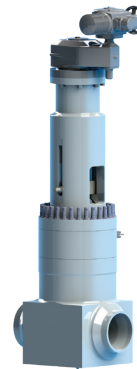

Designed for steam and water circuits, these valves operate in the event of a guillotine pipe-break or after an electric actuator switch-off failure. Their split wedge, limit switch control design provides superior leak tightness, precise wedge guiding and D-shaped wedges to avoid tilting.

- References: Germany, Sweden, Finland
- Size: up to NPS 24 / DN 600
- Pressure: up to class 2500 / PN 400
- Body material: forged CS and SS
- Qualification: Tests at GAP Karlstein

Various Auxiliary Circuits Applications (including RCV, EBS AND EVU)

Classified diaphragm and butterfly isolation valves

Fisher - DV and JMC

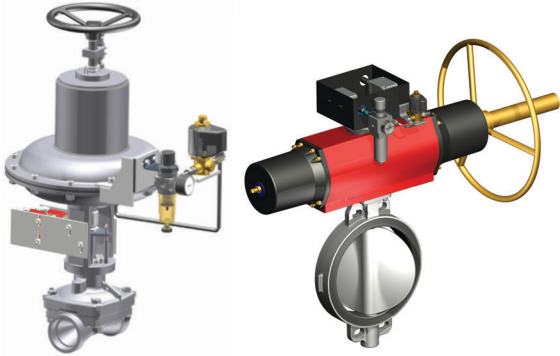

Used with a manual, electrical or pneumatical actuator for general isolation applications, these valves are highly reliable as only 2 parts are ever in contact with the fluid.

- References: PWR
- Diaphragm size: up to NPS 6 / DN150
- Diaphragm pressure class: up to 150 / PN20
- Butterfly size: from NPS 3 / DN80 to NPS 36 / DN900
- Butterfly pressure class: up to 150/PN20
- Qualification: RCC-M up to level 2; fully qualified for normal and accidental conditions

Classified spring-loaded safety valves

Crosby - J-Series



Direct spring-operated range of safety valves for liquid and gas applications.

- References: PWR
- Size: up to NPS 6 / DN 150
- Pressure class: up to 1500 / PN250
- Dampener available for multiple transient application
- Forged body construction
- Qualification: 1:1 with accidental condition
- ASME or RCC-M up to level 2

Vacuum and Check Relief Valves

Vacuum relief valves

Crosby - VR



Designed for vacuum relief applications, these valves protect piping and vessels when operating pressure is suddenly reduced because of system malfunction.

- Inlet/Outlet Sizes: NPS 1-10 / DN 25-250
- Connection: Flanged
- Capacity Certified: NB - 18
- Qualification: ASME Section III Class 2 & 3; Seismic/ environmentally qualified to ASME QME-1

Vacuum relief valves

Crosby - CV1B

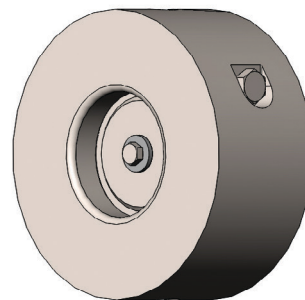

Wafer style body. These swing check valves are designed for use as a vacuum check valve to prevent flow in one direction.

- Inlet/Outlet Sizes: NPS 1-10 / DN 25-250
- Connection: Flanged
- Capacity Certified: NB - 18
- Qualification: ASME Section III Class 1, 2 & 3; Seismic/ environmentally qualified to ASME QME-1



Automatic Recirculation Valves

Crosby - Yarway 5300 ARC



Automatic recirculation control (ARC) valves are engineered to protect centrifugal pumps against thermal damage and destruction.

- Sizes: NPS 1-14 / DN 25-350
- Connection: Flanged & welded
- Pump protection for low flow events
- Qualification: ASME Section III Class 1, 2 & 3

Bellows Sealed Globe Valves

Crosby - G12 & Y12

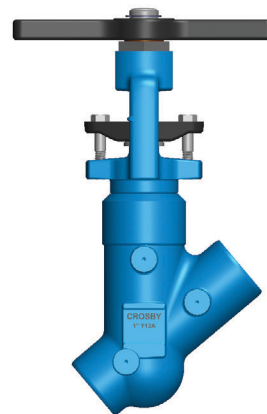

T or Y pattern bellows sealed globe valves designed for applications where process fluid leakage to the environment is unacceptable, e.g. radioactive, toxic, combustible, liquid metals, vacuum and helium gas, etc.

- Size: NPS ½-2 / DN15-50
- Pressure class: 150-1500 / PN20-250
- Connection: Socket Weld
- Body material: stainless or carbon steel
- Qualification: ASME Section III Class 1, 2 & 3; Seismic/environmentally qualified to ASME QME-1

Main steam system.

How can you achieve maximum efficiency and still maintain safety functions? The answer lies with Emerson's unique steam dump control valve. It not only improves the way you manage specific start-up transients, but is inherently safe, combining a fast opening function with the tightest shut-off available on a control valve.

What's your opportunity?

- Benefit from a pilot plug construction, providing high low-flow efficiency and a reduced actuator force
- Use the DVC6010 single smart positioner, a nuclear qualified K3+ with ambient temperature correction
- Leverage our MSSV modular approach, eliminating piping interfaces

Our integrated main steam valves enable compact and reliable design packages

Emerson's engineers have designed optimized units which integrate the Main Steam Isolation and Safety Valves. Welded and installed in a single compact package, this can be tested under operational conditions and is specific to the individual reactor technology.

Services offered

- Global and local support during commissioning, start-up and post start-up phases
- Services and application training
- Secured regulation through a smart positioner. This limits steam lamination of internal parts, with cut-off bandwidths features
- Performance diagnostics functions, offering a fleet management approach
- Mobile machining and welding equipment to enable on site services

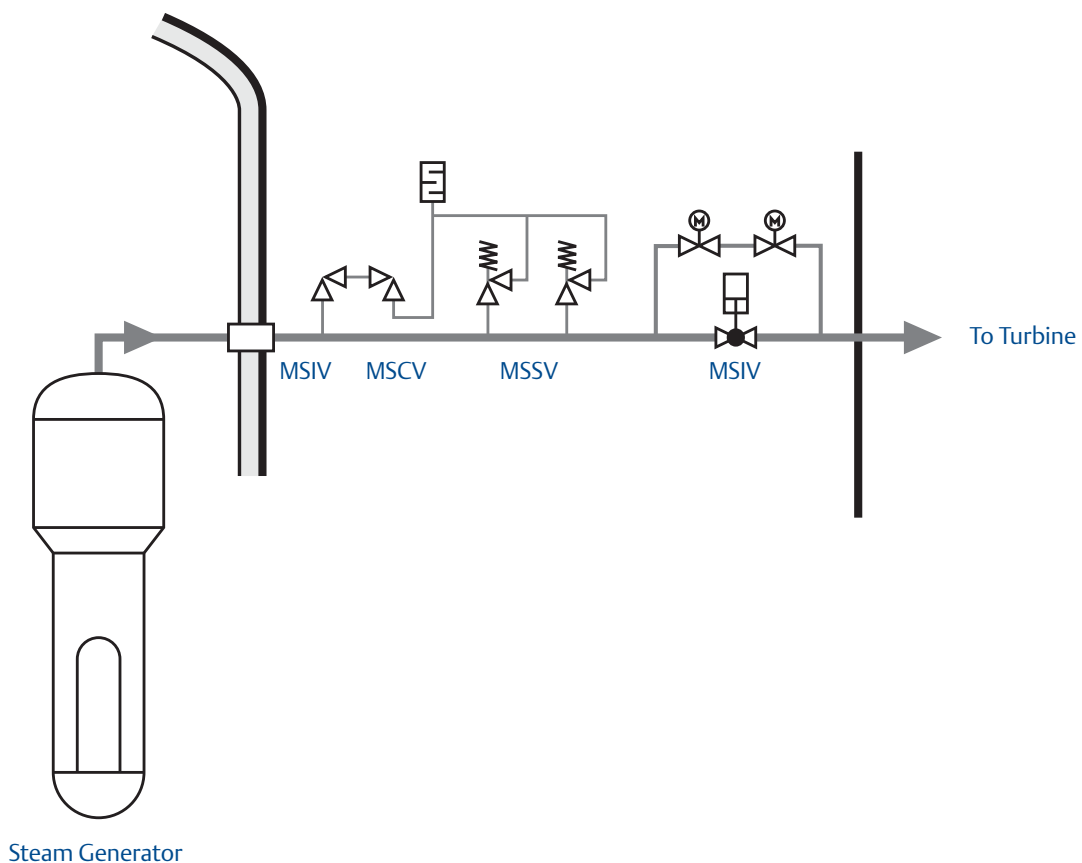

Steam Dump Control Valves (MSCV)

Pilotplug (straight) valves Fisher - EWP



This valve is an EVPNS seismic compliant design. It is typically used during atmospheric venting of the upstream from a high-pressure turbine or when steam is bypassed around a high pressure turbine to the condenser during start up.

- A pilot plug trim and clamped seat ring ensure easy maintenance
- Excellent metal to metal shut-off at high temperatures and shutoff pressure drops
- 667NS Seismic integrated actuator
- Smart positioner: DVC 6010 K3+ HELB qualified
- Size: NPS 6-12 / DN 150-300

Angle valves Fisher - ENAP



ENAP valves have a single-port angle body with cage-guided push-to-close main valve, plug loaded and unloaded by internal pilot plug.

- Used in EPR plants for normally closed applications (either on-off or low-flow throttling)
- Typical applications include steam dumps to the atmosphere or condenser
- Metal-to-metal single-seat shutoff at high temperatures and shutoff pressure drops
- Pneumatic or electric actuator used on Generation 3
- Size: NPS 12 / DN 300

Steam Dump Control Valves (MSCV)

Valve with electric actuator - VVER Sempell - 152

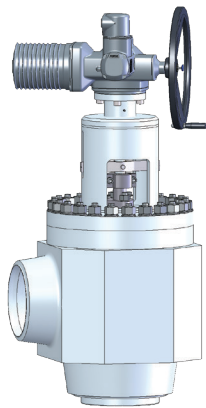

A quick-acting design.

- The balanced trim significantly reduces the actuator size
- Features a removable seat ring, wear-resistant materials, separated seat surface and control geometry
 - Inlet size: NPS 2 - 20 / DN 50 - 500
 - Outlet size: NPS 4 - 50 / DN 100 - 1250

Main Steam Isolation Valves (MSIV)

Angle globe valves for PWR Sempell - EBS32

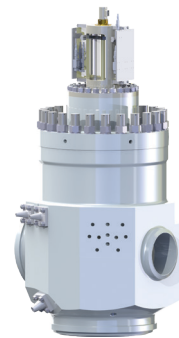

Fast acting, self-media operated isolation valves to ensure closing in an emergency mode.

A pneumatic actuator or coupling keeps the valve open in the absence of any system pressure. The valves provide excellent seat tightness.

- Stroke time: 3-5 seconds
- References: PWR, VVER
- Size: up to NPS 32 / DN 800
- Pressure class: 900 / PN 160
- Common body material: A105 (1.0460)
- Qualification: 1:1 scale tests with steam at GAP Karlstein

Main Steam Isolation Valves (MSIV)
Fast acting, self media operated isolation valves to ensure closing in an emergency

Y and angle pattern valves for BWR
Sempell -SSS9, ES99

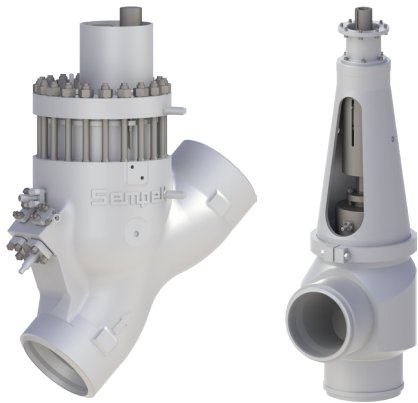

Y-pattern valve, first barrier inside containment, and angle type valve, second barrier outside containment. System media operated for fast closing.

- References: BWR Sweden
- Size: up to NPS 18 / DN 450
- Pressure class: 900 / PN 160
- Body material: cast steel WCB with stubs of forged steel A105 (1.0460)
- Qualification: Sempell laboratory

Main steam relief isolation valve
Sempell - TBS34

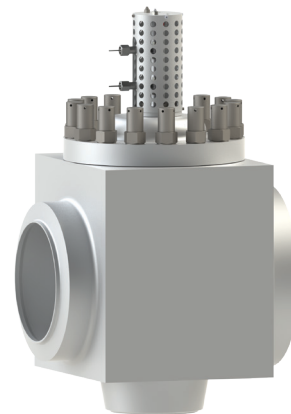

Isolation valve in front of steam dump control valve, self media operated. It provides isolation in case of non closure of steam dump valve.

- References: PWR, PWR (VVER), China
- Size: NPS 18 / DN 450
- Pressure class: 900 / PN 160
- Body material: P355QH1 (1.0571) 1.6310
- Qualification: 1:1 tests based on the GAP-Karlstein qualification for FSA Station

Main Steam Isolation Valves (MSIV)
Fast acting, self media operated isolation valves to ensure closing in an emergency

Wedge gate valves
Sempell - GPS50



Wedge gate valves have a mechanical coupling that keeps the valve open when there is no system pressure. An optional pneumatic actuator will also operate in the absence of system media.

- There is no disc seat contact during stroke
- Very compact design with low pressure drop
- References: BWR Finland, HTR China
- Size: up to NPS 32" / DN 800
- Pressure class: 900 / PN 160
- Body material: Carbon steel and stainless steel
- Qualification: Sempell laboratory and 1:1 scale tests with steam at GAP Karlstein

Parallel slide gate valves
Sempell - Eldidor



Parallel slide gate valves have a mechanical coupling that keeps the valve open in the event of zero system pressure.

- Stroke time: 3-5 seconds
- Very high force reserves for opening and closing
- References: PWR Germany, PWR (VVER) Russia, Ukraine, Czech Republic, Slovakia, Hungary
- Size: up to NPS 32 / DN 800
- Pressure class: 900 / PN 160
- Body material: cast steel WCB with stubs of forged steel A105 (1.0460)
- Qualification: 1:1 scale tests with steam at GAP Karlstein

Main Steam Safety Valves (MSSV)

Safety valves to avoid inadmissible pressure increases

Safety valves for BWR

Crosby - HB,DF



This main steam safety valve has been designed specifically for the exacting service and operating requirements of boiling water reactors (BWR).

- The alternative to remotely controlled automatic steam blowdown valves
- Valve opens automatically, or by means of an electrical solenoid valve, to actuate the valve by air cylinder
- Bellows "balances out" the effects of high backpressure in the discharge system
- Qualification: ASME Section III Class 1; Seismic/ environmentally qualified to ASME QME-1

Safety valves for PWR

Crosby - H Series



Direct spring-operated valves for pressurized water reactors (PWR).

- Inlet Sizes: 2.5 - 8 in (DN 65 - 200), Outlet Sizes: 6-10 in (DN 150 - 250)
- Forged or casted body: with flanged, studded or welded connections
- ISOFLEX®/FLEXI - Disc Insert Technology
- Quick opening (less than 80ms) and low overpressure (1%) application
- High tightness up to 96% of set pressure
- Qualification: 1:1 scale tests with steam and accidental conditions; ASME Section III Class 2, and RCC-M up to level 1

Main Steam Safety Valves (MSSV)

Safety valves to avoid inadmissible pressure increases

Safety valves for PWR and BWR

Sempell - VS99

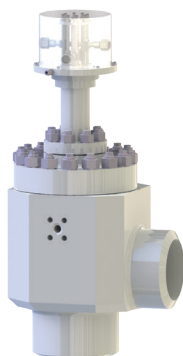

Forged design with direct mounted pilot valves. Low and high pressure in-situ test during operation. Accurate pilot set pressure opening value with <1% repeatability.

- References: Damped closing for PWR, Undamped for BWR
- Size: up to NPS 18 / DN 450
- Pressure class: up to 2500 / PN 420
- Body material: cast or forged carbon steel. Special material on request
- Qualification: 1:1 scale tests with steam at GAP Karlstein

Main Steam Safety Valve Sets

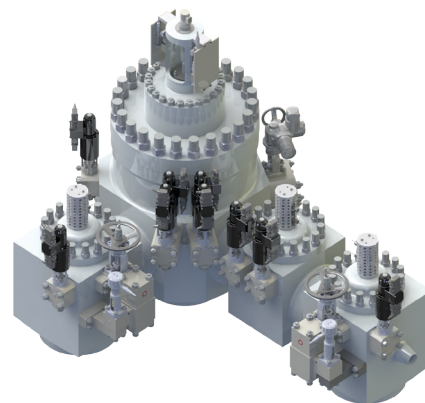

Main Steam Valve Sets are totally integrated to provide main steam isolation and safety relief to the atmosphere, in the event of failures.

The safety and isolation valve bodies are welded to the MSIV body to produce the most compact design.

In PWR, our valve set integrates four valves. The MSIV and MSSV are supplemented by a blow-down isolation valve, which is installed upstream of the main steam control valve to vent the pipe to the atmosphere.

Feedwater system - Nuclear and conventional islands.

When it comes to maintaining the level control in a steam generator, it is critical that you achieve absolute accuracy in the shortest possible transient time. Only then can you be certain the generator loops are well-balanced and compliant with all stability regulations.

What's your opportunity?

- Emerson's smart positioner solutions, with remote interfaces, help you deal with extreme ambient conditions
- Employ a separate active application, which is available for Safeguard circuits

Emerson's digitalization solutions are proven over two decades

Thanks in part to Emerson, implementation via a smart positioner is now commonplace on nuclear industry applications. And we continue to provide solutions for upgrading valve regulation on all valves, including competitors, as part of our Nuclear Safety Commitment.

Services offered

- Global and local support during commissioning, start-up and post start-up phases
- Services and application training
- Cavitation treatment integrated on bypass control flow valves to increase internal parts lifetime
- Diagnostic 2.0 already available OEM tools in a secured environment

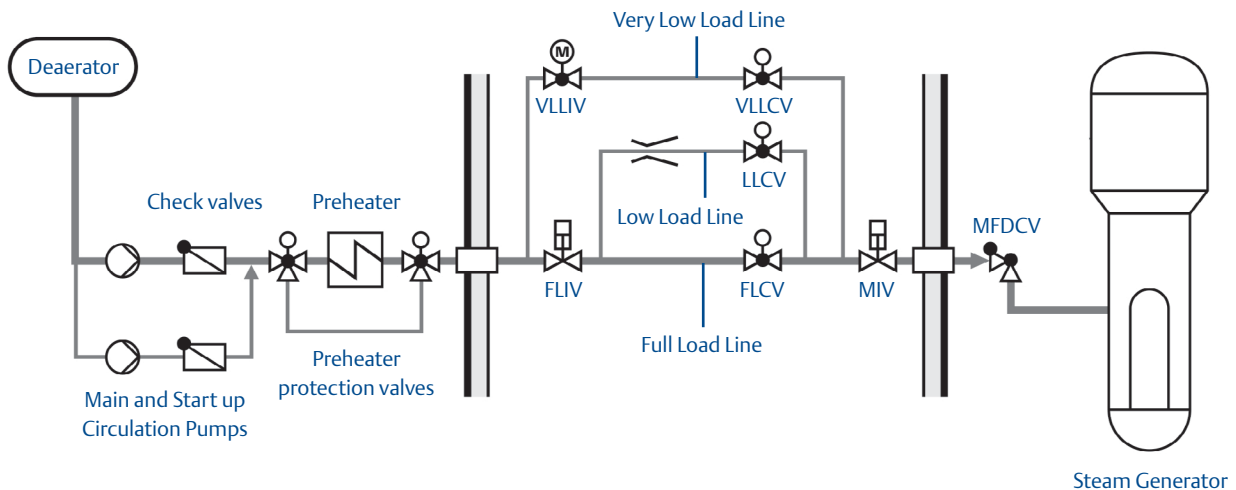

Main valves Fisher - EUT

This globe valve with EUT design is a single port control valve, balanced valve plug, cage guiding and metal to metal seating for all applications over a wide range of process pressure drops and temperature.

- Throttling or on-off control of a wide variety of liquids and gasses
- Different material combination for trim Type T construction, for temperature range between -49°C and +316°C
- Smart Positioner DVC is usually implemented with remote functions DVC6205/6215 to manage vibrations and temperature up to 100°C
- Available in Seismic Construction
- Size: up to NPS 20 / DN 500



Main and start-up valves - PWR Fisher - EWNS

Globe straight or angle style valves with live loaded graphite packing and seismic bonnet on a designated piston or air operated actuator. Installed in EPR and AP1000 nuclear plants.

- Compliant with Generation 3 plants, proved with dedicated qualification programs
- Body/Actuator connection designed for Seismic Compliance
- Bi-directional Anti-Extrusion Seal trim, available with characterized flow cages
- Available with bore seal trim for high temperature applications and Cavitrol or Whisper Trim options, Class V shutoff

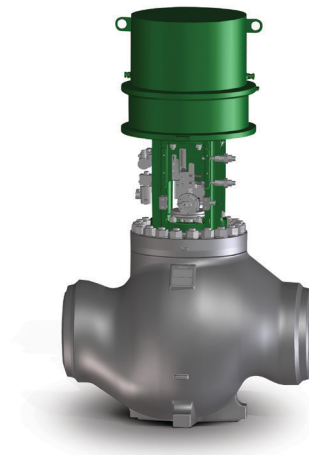

Main valves with electric actuator - VVER Sempell - 140 series

Constructed from wear resistant materials, 140 Series valves have throttling stages that are purpose designed to eliminate cavitation damage.

- A balanced trim significantly reduces the actuator size
- Also available as angle-type and Z-type
- Removable seat ring
- Pressure: according to customer specification
- Size: NPS 1 - 20 / DN 25 - 500



Preheater Protection Valves

Inlet and outlet valves for preheater protection Sempell - AVS4/5



Changeover valves protect preheater systems against the consequences of a break in the high-pressure feedwater pipes.

- Body material: cast steel for low pressure or forged steel for high pressure
- Medium operated according to the releasing principle, with a blocking stem
- References: Germany, Sweden, Finland, Eastern Europe
- Size: NPS 3 - 18 / DN 75 - 450
- LP Pressure Class: 150 - 600 / PN 20 - 100
- HP Pressure Class: 900 - 2500 / PN 150 - 420

Main Feedwater Isolation Valve (MFIV)

Pipe-break isolation gate valves Sempell - GPS50



Pilot operated gate valves with mechanical coupling to keep the valves open in the absence of system pressure and pneumatic actuator for operation in absence of system media.

- Fast closing in emergency modes
- References: BWR Finland, HTR
- Size: up to NPS 24 / DN 600
- Pressure class: 150 / PN 20
- Body material: carbon steel and stainless steel
- Qualification: Sempell laboratory with saturated water

Gate and Check Valves

Parallel slide gate valves Sempell - HP series

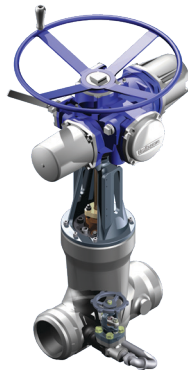

These high pressure gate valves have an electrical actuator that enables them to operate effectively in extreme applications.

- References: PWR, Chinese ACP1000, HL1000
- The enhanced compact bolted bonnet for high pressure offers greater reliability than a pressure seal bonnet
- Up to RCC-M level 2
- Body material: 20M5M (1.1131) (casted)
- Qualification: 1:1 scale tests and accidental conditions (including earthquake and end-loading)

Damped and swing check valves Sempell - EBS30, HKS5

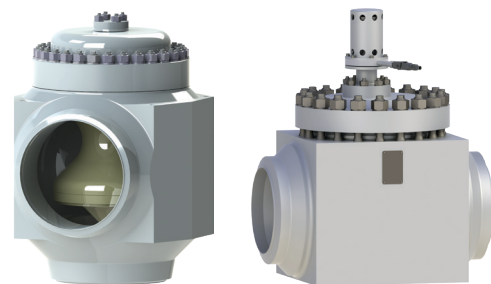

Main feedwater damped check valves for pipe-break protection and swing check valve for pump protection.

- One-piece block-design, with position indicators available on request
- References: PWR, VVER Russia, Sweden
- Size: up to NPS 18 / DN 450
- Pressure class: 1500/PN 250
- Body material: A105 (1.0460), F 508 and SS
- Qualification: Test-loop HDR Kahl and seismic tests



Turbine island.

On a turbine island the steam first expands into the turbine in a high pressure (HP) path. After moisture separation and reheating, it then expands in an intermediate pressure (IP) section before going through several pressure (LP) flows. The turbine bypass valve operates during the start-up and shut-down phases of a plant, or whenever a sudden load shedding of the turbine takes place. This requires the reliable actuation Emerson valves deliver, to divert the steam coming from the steam generator and secure valve tightness during normal plant operation.

What's your opportunity?

- Select a design to suit your needs from our large choice of turbine bypass valves, including straight-through, angle and Z types
- Benefit from parallel side gate valves that are purpose designed for the turbine island
- Take advantage of the compactness of our check valves, with a special bolted bonnet for high pressure applications

Reduce your maintenance and operating costs

Emerson's engineers have developed and qualified a straight-through turbine bypass valve that has a special pilot disk, which significantly reduces the size of the actuator. Similarly, our parallel side gate valves use smaller actuators to operate, thereby reducing installation, operation and maintenance costs. While our turbine bypass valve design also features a multistage trim to ensure low noise and anti-vibration performance.

Services Offered

- Global and local support during commissioning, start-up and post start-up phases
- Services and application training
- Diagnostic solutions for conditional approach
- Maintenance programs
- Mobile machining and welding equipment to enable on site services

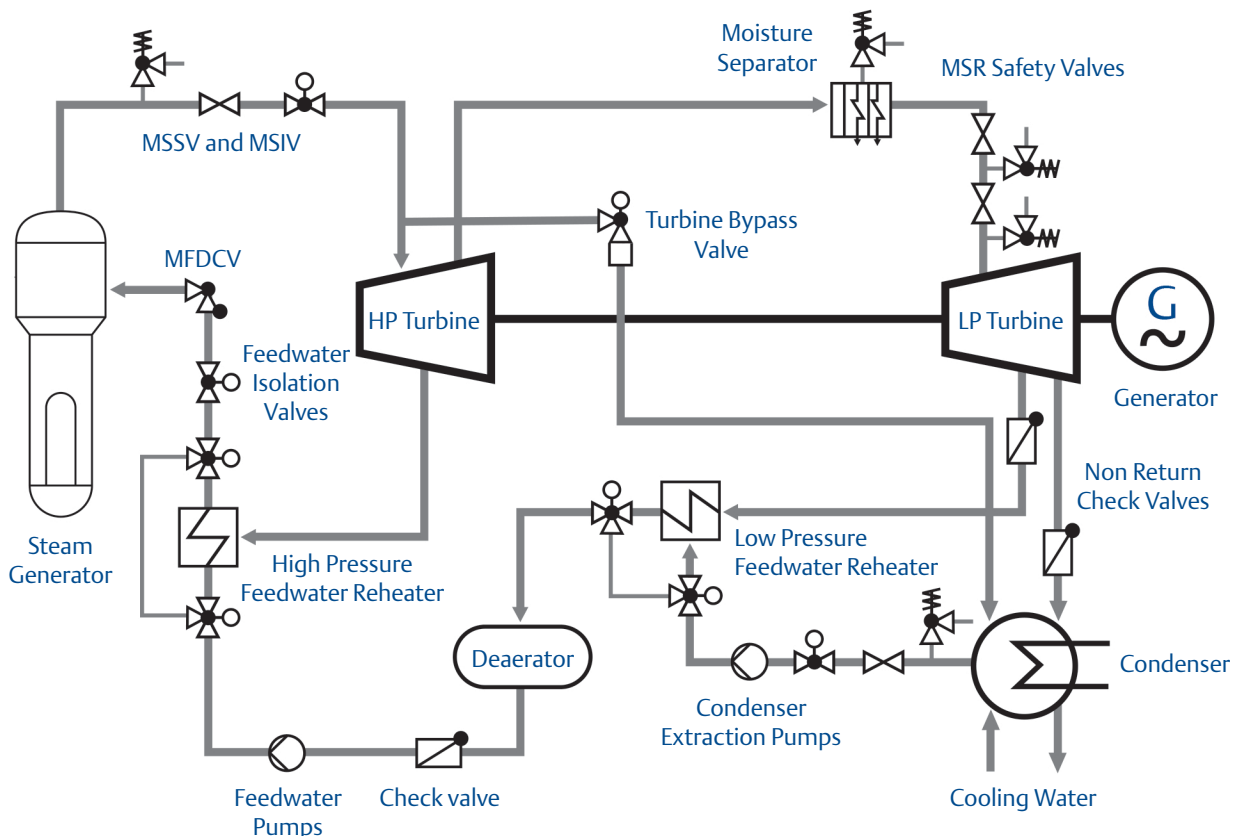

Turbine Bypass Valves

Main steam turbine bypass valves Sempell - 151N



Our straight through and angle type designs divert steam from the steam generator into the condenser during the start-up and shut-down of the plant.

- References: for VVER and ACPR design
- Quick-acting design with a removable seat ring
- A balanced trim significantly reduces the actuator size
- Wear resistant materials, separated seat surface and control geometry
- Excellent valve tightness during normal operation
- Inlet Size: NPS 2 - 20 / DN 50 - 500
- Outlet Size: NPS 4 - 50 / DN 100 - 1250

Main steam turbine bypass valves Fisher - EHAT



These angle style valves have a hung cage and screwed in seat ring retainer, which deliver uncompromising reliability in the most severe service applications.

- Installed in AP1000 PWR
- Engineered for high pressure applications
- Body/actuator connection designed for seismic compliance
- Anti-extrusion seat trim, Class V shutoff.
- Standard, Whisper and Cavitrol trims also available
- Qualification: ASME B16.34, Commercial Grade Application

Isolation Valves

High pressure wedge gate valves Sempell - GA251

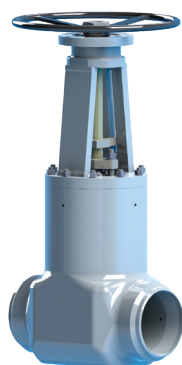

Pressure seal, limit switch controlled split wedge gate valves. Designed for water and steam applications, they offer excellent seat tightness in both directions, as well as at low system pressures.

- References: PWR China, FBR Russian Federation
- Options for upper valve cavity overpressure protection
- Stellite hardfacing of seat surfaces
- Size: up to DN 24 / DN 600
- Pressure class: up to 4500 / PN 720
- Body material: CS, high-temperature steel
- Qualification: Sempell laboratory

Parallel slide gate and check valves Sempell - Low and high pressures

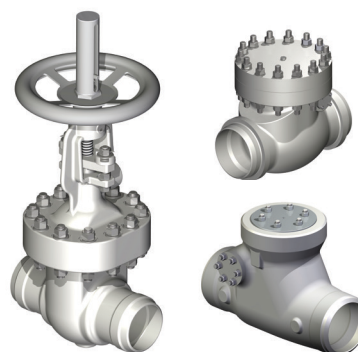

Specially designed with Turbine Supplier, these valves can be used with manual, electrical or pneumatical actuators, to provide reliable operation in high temperature steam and water applications.

- References: PWR, Chinese ACP1000, HL1000
- Bolted bonnet for low pressure applications
- An enhanced compact bolted bonnet has been designed for high pressure applications - ensuring greater reliability than pressure seal bonnets
- Qualification: 1:1 scale tests and accidental conditions; up to RCC-M level 2

Isolation Valves

Butterfly and diaphragm isolation valves Fisher - JMC & DV

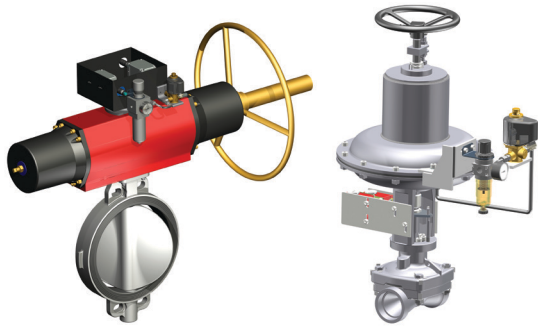

Designed to be used with manual, electrical or pneumatical actuators, these valves are ideal for low pressure and low temperature isolation applications.

- A folded diaphragm enables straightway flow and limit retention
- Elastomer tightness for a perfect and reliable tightness
- Diaphragm design size: up to NPS 6 / DN150 and pressure up to class 150 / PN20
- Butterfly design size: from NPS 3 / DN80 to NPS 36 / DN900 and pressure up to class 150 / PN20
- Qualification: RCC-M up to level 2; Fully qualified for normal and accidental conditions

High pressure wedge gate valves Sempell - GPS4



Purpose made for water and steam applications, these valves provide excellent seat tightness in both directions and at low system pressures.

- Bolted bonnet, limit switch controlled split wedge design
- Stellite hard facing of seat surfaces as a standard
- Size: up to DN 24 / DN 600
- Pressure class: up to 2500 / PN 400
- Body material: forged CS and SS
- References: PWR, BWR
- Qualification: Sempell laboratory

Isolation Valves

High pressure globe and check valves Sempell - VA500, VR500, VR540



VA500 T-pattern globe type valves in a one-piece die-forged body design. VR540 and HP screw down non-return valves. VR500 Piston check valves.

- Trouble-free actuator refitting on globe valve designs
- Throttling disc option for low differential pressure
- Wear resistant stellite seats
- Low pressure loss due to optimized flow path
- Pressure class: 2680 / PN 500
- Pipe size: NPS ½ - 2 ½ / DN 10 - 50
- Qualification: ASME B16.34 and PED type tested

Butterfly valves Crosby, Keystone



High performance butterfly valves capable of drop-tight closure in vacuum and throughout all pressure ranges, as well as at full rated differential pressure.

- Integrally cast mounting pad provides direct mounting of many actuators
- Integrally cast disc position stop perfectly locates the disc in its seat, achieving maximum seat and seal life
- Qualification: Available for ASME Section or commercially dedicated to 10 CFR 50 Appendix B & 10CRF Part 21

Safety Valves

Spring-loaded safety valves for moisture separator

Crosby - JB, Sempell - Maxi S



A range of direct spring-operated safety valves, featuring bellows. Our large capacity safety valve is used for moisture separator and reheater applications, as well as other turbine island circuits.

- References: PWR, Chinese ACP1000, CPR1000, HL1000
- Body material: Casted body construction available in multi materials, with flanged connections
- Sizes: NPS 10-20 / DN 250-500
- Bellows “balances out” the effects of high backpressure in the discharge system
- Qualification: ASME Section VIII and RCC-M; NB - 18 certified

Spring-loaded safety valves for standard applications

Sempell VSE, R, S-Series



Pop action valves with mechanical lift stop ensures functional stability. VSE series have piston/guide bush trim path design. S-series have bell type trim path design.

- High allowable back pressure
- Balanced bellows available; block body design on request
- References: Germany, Sweden, Finland, Eastern Europe, Brazil
- Pressure Class 2500/PN 420
- Size: NPS 1 - 10/DN 25 – 250.
- Qualification: VdTUV type-tested

Safety Valves

Spring loaded safety valves with proportional opening characteristic

Sempell - PSE

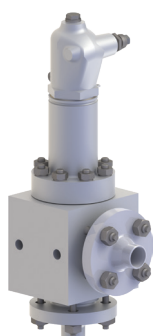

PSE valves are used specifically in liquid applications where a proportional characteristic is required. Above set pressure, these valves open steadily with increasing pressure ensuring only the necessary capacity is relieved during opening.

- Block-body design or cast
- References: Germany, Sweden, Finland
- Size: NPS 1 - 6 / DN 25 - 150
- Pressure class: 2500 / PN 420
- Body material: stainless steel or carbon steel
- Qualification: VdTUV type-tested

Pilot operated safety valves

Crosby - JPV-A



Our JPV-A valves have a smooth but quick operation and are perfectly suited to high flow applications.

- References: PWR, Chinese ACP1000, CPR1000, HL1000
- Compact design with no external pipe for an easy installation
- Body material: Casted carbon steel with flanged connections
- Inlet Sizes: NPS 10-20 / DN 250-500
- Outlet Sizes: NPS 14-24 / DN 350-600
- Qualification: ASME Section VIII and RCC-M; NB - 18 certified

Instrumentation.

Emerson have always been one step ahead for nuclear instrumentation. This is because our instruments and regulators continually help nuclear applications to comply with global qualification requirements, and are simply not reliant on third-party manufacturers. We are also used to dealing with nuclear grade instruments for generic commercial applications, providing solutions up to Safety Class 1.

What's your opportunity?

- Benefit from obsolescence management through nuclear reference files
- Get engineered solutions for your sustainable product upgrades
- Critical applications are sourced from Emerson's nuclear community
- Take confidence from a large and long-term qualification program
- Use only dedicated nuclear grade products

Emerson is an integral part of the nuclear community

For over 55 years, Emerson's engineers have designed and qualified reliable solutions that are compliant to international nuclear codes, such as RCCE, IEEE and KTA.

Services Offered

- Global and local support during commissioning, start-up and post start-up phases
- Services and application training
- Our service covers the complete integration of your valves, with remote panel integration achieved through dedicated plug-and-play assembly kits
- Emerson diagnostic solutions enable precise instrument tuning
- Turbine Island

Positioners, regulators, volume boosters and locking devices
Inside containment :
up to K1 (LOCA) Qualification

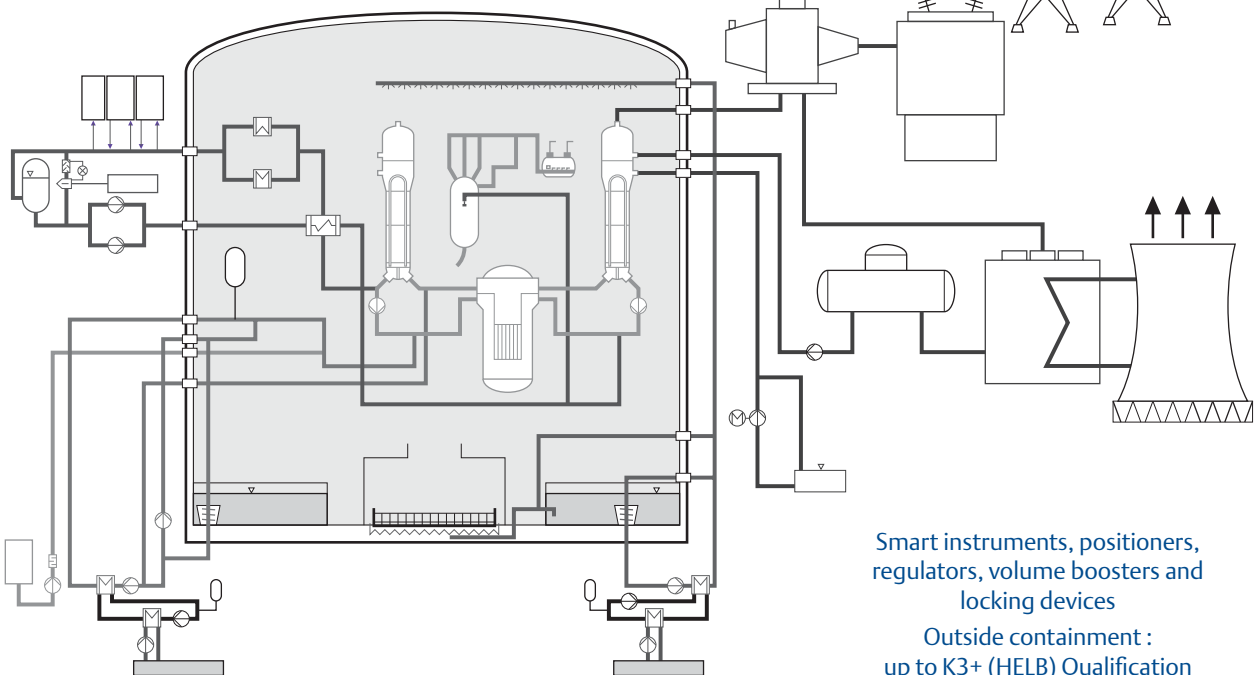

Smart instruments, positioners,
regulators, volume boosters and
locking devices
Outside containment :
up to K3+ (HELB) Qualification

Smart Instrumentation

Digital valve controllers

Fisher - DVC6000 /6200 series



The DVC 6000 / 6200 series allow operation to run closer to set point, with more accurate control.

- The remote version (DVC 6205 / 6215) supports vibration and temperature in mild environment
- Fluorosilicon elastomers enable operation at high temperatures
- Options, such as cut offs at low flow rates, counters and alerts etc.
- Qualification: DVC 6010 is K3+ HELB qualified; Seismic and environmental qualification reports

Digital level controllers

Fisher - DLC3000 /3200 series



The DLC3000 / 3200 level controller is installed on many Leveltrols of nuclear power plants.

- Fluorosilicon elastomers enable operation at high temperatures
- Options, such as cut offs at low flow rates, counters and alerts etc.
- Qualification: Seismic and environmental qualification reports

Nuclear Instrumentation

Safety positioner

Fisher - 3582



These qualified pneumatic devices can be used on sliding stem valves, rotary spring return valves and piston actuators allowing accurate and fast response.

- Low steady state air consumption ensures an efficient operation
- Operability: EPDM/PEEK constructions tested on harsh and Accidental environmental
- Additional pneumatic tire valves facilitate common maintenance and quick diagnostic services
- Qualification: RCC-E LOCA K1,K3; IEEE

Electro pneumatic I/P transducer

Fisher - 546NS



An electro-pneumatic signal transducer equipped with elastomers for use in elevated temperature and radiation environments. Also stabilized with a cooked relay to withstand harsh nuclear conditions.

- The high natural frequency of the torque motor's moving parts results in negligible vibration influence
- Explosion-proof case and cover, EPDM elastomers
- Qualification: available as Safety Related in RCCE K1, K3; IEEE qualified

Nuclear Instrumentation

Pressure regulators

Fisher - 67 and 95 series



Compact and lightweight nuclear harsh qualified direct-operated supply regulators.

- 67 series regulators: provide reduced pressures to pneumatic/electro pneumatic controllers, I/P converters, boosters and other instruments - for most air or gas applications
- 95 series regulator handle inlet pressures up to 600 psig (41,4 bar)
- Outlet ranges: up to 400 psig

Volume boosters

Fisher - 2625, VBL

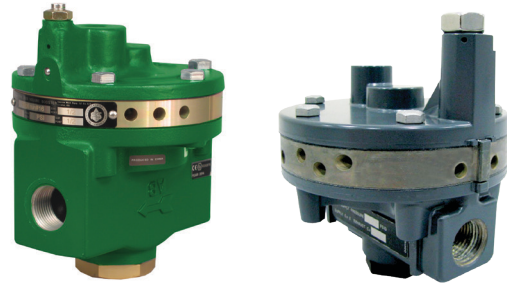

This pneumatic booster is used in conjunction with a positioner on a throttling control valve to increase the stroking speed.

- Fixed dead band, soft seat construction
- Responds to small input signal changes without sacrificing control valve steadiness
- Common usage on ON/OFF application to enhance valve speed
- Qualification: EPDM elastomeric for nuclear island compliance

Nuclear Accessories

Position transmitter

Fisher - 4211



A transmitter that senses position of rotary or sliding stem valves, vents, dampers or other devices.

- Can provide alarms on high and low electronic travel limits
- Now used in most critical applications from Gen 3
- Qualification (in progress): for seismic and degraded conditions

Valve position indicators

Crosby - VPI and lift indicating switch assembly (LISA)



LISA is a valve position indicating device with a movable permanent magnet attached to the valve spindle. VPI device permits the safe monitoring of pressure relief valves in harsh environments, by providing direct, continuous and remote indication.

- Fixed 'reed' type switches are permanently encased in epoxy
- Two sets of switches provided redundancy
- Each switch set consists of three switches which indicate the valve closed, mid and full open positions
- VPI system handles up to 20 Linear Variable Differential Transducer (LVDT) sensors
- Qualification: to IEEE-344 for in-containment service Transducer qualified to Class 1

Nuclear Accessories

HP regulators Fisher - 1301

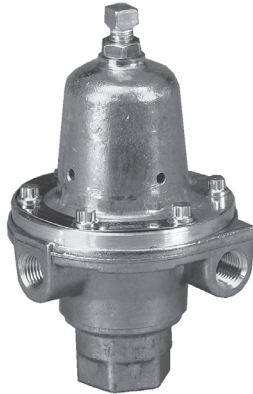

Multifluid high pressure regulators which can be used for reactor water.

- Body material: ¼" forged brass or stainless-steel bodies
- Inlet pressure: up to 6000 psig
- Outlet pressure: 10-500 psig
- ANSI CI VI Shutoff
- 5/64" Orifice CV 0.13
- Multiple end connections

Switching and locking devices Fisher - 167D, 164A

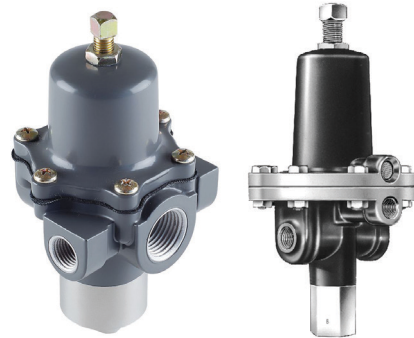

The two-way (167D) and three way (164A) switching valves can provide constant pressure reducing, venting and drive failure mode positions on spring return actuators.

- Compact, lightweight package
- Easy, accurate adjustment with large range of springs
- Available with standard and high temperature FKM (167D) and EPDM (164A) elastomers
- Qualification: seismically and environmentally qualified with FKM (167D) and EPDM (164A) elastomers; 167D can be supplied in accordance with 10CFR 50 App. B and 10CFR Part 21; 164A with RCC-E - Level K1

Nuclear Accessories

Interlocking systems for safety related isolation valve configurations Sempell - A1- A5, A301

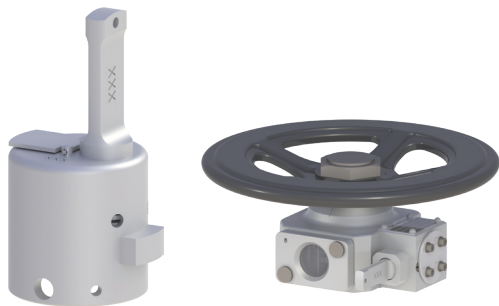

Interlocking system with a mature and approved design.

- No jamming or braced parts and operating threads
- Allows longer operation time
- Type S A1 - A5: offers options for one or two keys as sequence locks (not adjustable)
- Type A 301: is adjustable and suitable for a change of locking position
- Qualification: ISO 5210 compliant type tested

Trip valves Fisher - 377



When supply pressure falls below a specific point, a trip valve causes the piston actuator to fail up, fail down or lock in last position.

- It can be top-mounted on a manifold, yoke mounted or bracket-mounted
- Trip design includes large diaphragm areas and few moving parts - ensuring efficient performance, minimum maintenance and a long service life
- Trip point is adjustable from a minimum of 2.8 bar / 40 psig to a maximum of 72% of supply pressure
- Qualification: seismically and environmentally qualified with fluorocarbon elastomers; can be supplied in accordance with 10CFR 50 App. B and 10CFR Part 21

Emerson nuclear lifecycle services.

Achieve Operational Certainty with our lifecycle services support

Emerson has the experience, knowledge and proven capability that are critical in delivering expert services for nuclear power generation today. Our highly certified service technicians are working closely with nuclear power operators across the globe to ensure their plants remain safe, efficient and viable.

By maintaining your valve assets to the highest standards, our service engineers can help you achieve Operational Certainty - with true peace of mind. As the name behind many of the world's most respected valves brands, there is nobody better placed to optimize the maintenance, reliability and performance of all your assets, regardless of their specification or manufacturer.



Maintenance

Keep your plant operating safely, consistently and economically



Documentation services



Education



Onsite repair

Reliability

Improve your asset reliability and preserve your investment



OEM services

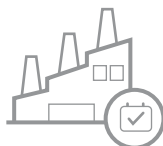

Shutdown, turnaround, outages



Onsite diagnostics

Performance

Optimize your plant performance goal



Resident engineer



Fleet management



Pressurizer safety relief valves



Maintenance

Keep your plant operating safely, consistently and economically

We can provide nuclear plant operators with an optimized maintenance plan, that will help to minimize costs without compromising safety or reliability. Expect nothing less than the total solution. One that covers every aspect of mechanical maintenance, from on-site machining and welding to instrumentation tuning.

Documentation services

It can be a major challenge to produce full traceability for the lifetime of a nuclear power plant - unless you can rely on a Main Valve Partner™ like Emerson. Our documentation service consistently provides detailed evidence on services carried out going back decades. Our Documentation Services include:

- A dedicated Quality Assurance system for documentation services
- Expertly managed on-site document submissions
- A Site Activities Report compiling diagnostics and mechanical activities (submitted on the last day before leaving your site)

Onsite repair

Machining, grinding & welding excellence

Our maintenance experts are unique in having the capability to execute these critical sequences in accordance with all proprietary data, through:

- Mobile turning technology - directly installed on-site, with cutting tools that enable us to work on all valve surfaces.
- High quality mobile grinding solutions for sealing or functional surfaces
- Modern 3D design programs - creating new valve machining solutions on-site
- Mobile welding equipment - operated by trained and certified experts who can ensure valves are compliant with your specifications

Education - Certified ISO 29990

Consider Emerson training as the effective short- and long-term solution to maximizing the return on that most significant investment: your employees. We can provide your workforce and customers with the knowledge they need to not only perform their jobs, but also find efficient solutions to daily issues. Our training programs include:

- Standard courses
- On-site and customized training programs
- Specific training courses at our Nuclear Service Centers and manufacturing locations worldwide
- Training programs for all people working within the nuclear industry, in combination with Safety Authorities





Reliability

Improve your asset reliability and preserve your investment

Emerson's service engineers will also help you to reliably sustain the performance and safety levels of your valves, whilst keeping maintenance costs in check. One day of non-production in a nuclear plant can amount to a direct loss of one million dollars and have a huge impact on your distribution network. So, it is crucial that you have a long-term maintenance strategy in place, supported by equipment condition diagnostic tools.

OEM services

Emerson is the name behind a host of valve brands that have become a byword for excellence in the nuclear industry. As such we are the first people to speak to regarding any on-site valve issues, from commissioning through to dismantling. We offer:

- Product compliance support, from commissioning to installation
- Best practice sharing, based on our many years experience.
- A dedicated site service leader who will help you with logistic management, shutdown scheduling and radiation hygiene
- Equipment maintenance operations including machining and welding, for critical sequences and requalification

Onsite diagnostics

Emerson technicians can perform vital tests and diagnostics to indicate which valves need your attention before problems occur. They analyze them in the loop, using our dedicated and unique diagnostic tools. Diagnostics data is used to optimize and preserve your asset reliability and safety.

- **FlowScanner™**
QUIKLOOK diagnostic system

Suitable for all air and motor operated valves, this enables us to check conformity criteria to the same high standards as we undertake in our manufacturing plant

- **SESI TEST**
For Spring-Loaded Pressure Relief Valves

We can execute the on-site test in operation and we have access to setup opening pressure and also released pressure

- We can also centralize your diagnostic signature on a single dedicated database

Shutdown, turnaround and outages

Properly planned shutdowns, turnarounds, and outages can be ideal opportunities to align maintenance with your business goals. Using our processes and trusted advisors, we can develop a maintenance plan that can maximize your return on investment and reduces risk. Moreover, we can offer a dedicated framework agreement that covers your needs.

- Whilst classified spare-parts are subject to a long lead-time, our diagnostic capabilities allow us to proceed directly to verification and availability of any inventory
- Emerson offer a dedicated framework agreement that covers your needs
- We provide a suitable list of kits by maintenance activity typology
- The Quick Ship program ensures a fast, flexible shipment of key parts





Performance

Optimize your plant performance and reach your operational targets

Emerson's global upgrade, obsolescence and QuickShip programs ensure Operational Certainty for nuclear installations across the globe. It is in our DNA to share our experiences of best practice. We are committed to continually bringing you the services you need to keep your plant running safely and productively.

Resident engineer

Place a pre-qualified, trained engineer at your facility under an extended contract. Benefit from field support, project management, and consulting expertise you need for success without the hassle and expense of hiring new permanent personnel.

Pressurizer safety relief valves services

Emerson has set up a dedicated task force to engineer solutions to one of the most complex applications in a nuclear power plant.

- From our manufacturing base in Korschenbroich, we work closely with nuclear plants around the world
- Emerson service engineers have a global understanding of product complexity, including mechanical construction and I&C responsiveness

We provide a mandatory presence on all major commissioning milestones and provide maintenance contracts with the assistance of expert engineers to ensure continuous operation of this key asset over time.

Fleet management

The experience and know-how of our team means Emerson can manage up to 10 shutdowns in parallel with a centralized service management.

- Our experts have a global understanding of fleet management, offering support solutions through Annual Safety Notifications/Reports
- As your trusted Main Valve Partner™ we can gather relevant information to identify your issues and deliver the perfect diagnosis.
- Required information is delivered by nuclear experts within 48 hours, except for specific requirements



Supporting nuclear facilities across the globe.

Emerson has been actively involved with the nuclear industry since commercial nuclear power stations first became operational 50 years ago. We now have equipment in over 390 units located across the globe using a variety of different reactor designs, this represents over 85% of all units in operation. We have a unique portfolio of products for new build and to support nuclear power plants over their entire lifecycle.

Our products can be found in the following reactor types

Pressurized water reactors (PWR)

Including advanced technologies such as AP1000, EPR, APR1400, VVER and Hualong One.

Boiling water reactors (BWR)

Pressurized heavy water reactors (PHWR/Candu)

The number of units in operation worldwide using Emerson valves

North America **118**

Latin America **5**

Western Europe **110**

Central and Eastern Europe **45**

Asia **111**

Africa **2**



International certification and standards.

Emerson's factories and Q.A. procedures are not only inspected and audited regularly by major quality authorities but are in full compliance with the following international rules and standards*.

ASME Section I

ASME Section III N. NV. NPT

ASME Section V

ASME Section VIII UV

ASME Section IV

ASME Section XI

RCC-M

KTA 1401

DIN EN ISO 3834-2

DIN EN ISO 9001:2015

ISO 14001:2015

PED 2014/68/EU

OHSAS 18001:2007

CSEI

SGU-Management System

HAF 604 and HAF601

10CFR50 Appendix B

CEFRI-E

ISO 29990

*Certain manufacturing sites may not hold all of these certifications.



Improve your plant safety, flexibility and reliability.



Emerson Manufacturing Plants and Engineering Centers for the Nuclear Industry

USA

55 Cabot Blvd
Mansfield, MA 02048
United States of America
T+1 508 594 4200

France

Rue Paul Baudry, BP 10150
68701 Cernay Cedex
France
T +33 3 89 37 60 02

Germany

Werner-von-Siemens-Straße
41352 Korschenbroich
Germany
T +49 2161 61 50

USA

301 South 1st Avenue
Marshalltown, Iowa 50158
United States of America
T +1 641 754 3011

France

8, Avenue Pierre Brossolette
59280 Armentières
France
T +33 3 20 10 55 00

China

No.15 Xing Wang Road
Wuqing Development Zone
Tianjin TJ 301700
China
T +86 22 8219 4888

support.nuc@emerson.com



Emerson.com



[Facebook.com/EmersonAutomationSolutions](https://www.facebook.com/EmersonAutomationSolutions)



[LinkedIn.com/company/Emerson-Automation-Solutions](https://www.linkedin.com/company/Emerson-Automation-Solutions)



[Twitter.com/EMR-Automation](https://twitter.com/EMR-Automation)

© 2020 Emerson Electric Co. All rights reserved. Main Valve Partner, Fisher, Sempell, Crosby, Fishtail, Vee-Ball, easy-e, and FlowScanner are marks owned by one of the companies in the Emerson Automation Solutions business unit of Emerson Electric Co. Emerson, and the Emerson logo are trademarks and service marks of Emerson Electric Co. All other marks are the property of their respective owners. The contents of this publication are presented for informational purposes only, and while every effort has been made to ensure their accuracy, nothing herein is to be construed as a warranty or guarantee, express or implied, regarding the products or services described herein or their use, performance, merchantability or fitness for a particular purpose. Individual results may vary. All sales are governed by our terms and conditions, which are available upon request. We reserve the right to modify or improve the designs or specifications of our products at any time without notice. Responsibility for proper selection, use and maintenance of any product or service remains solely with the purchaser and end user. (*) Target Rock is a trademark of Target Rock, a business unit of the Curtiss- Wright Industrial Division – Valve Group. VCPBR-10626-EN 20/10



CONSIDER IT SOLVED™