

Rosemount™ 499AOZ

Dissolved Ozone Sensor



Safety information

⚠ CAUTION

Sensor/process application compatibility

The wetted sensor materials may not be compatible with process composition and operating conditions.

Application compatibility is entirely the operator's responsibility.

⚠ CAUTION

Equipment damage

Do not exceed pressure and temperature specifications

Pressure: 65 psig (549 kPa abs) max.

Temperature: 32 to 122 °F (0 to 50 °C)

⚠ WARNING

Physical access

Unauthorized personnel may potentially cause significant damage to and/or misconfiguration of end users' equipment. This could be intentional or unintentional and needs to be protected against.

Physical security is an important part of any security program and fundamental to protecting your system. Restrict physical access by unauthorized personnel to protect end users' assets. This is true for all systems used within the facility.

Contents

First steps.....	3
Install.....	6
Wire.....	10
Calibrate.....	15
Maintenance.....	17
Accessories.....	20

1 First steps

1.1 Unpack and inspect

Procedure

1. Inspect the shipping container. If it is damaged, contact the shipper immediately for instructions.
2. If there is no apparent damage, unpack the container. Be sure all items shown on the packing list are present. If items are missing, notify Emerson immediately.

1.2 Product description

Figure 1-1: Rosemount 499AOZ Sensor Parts

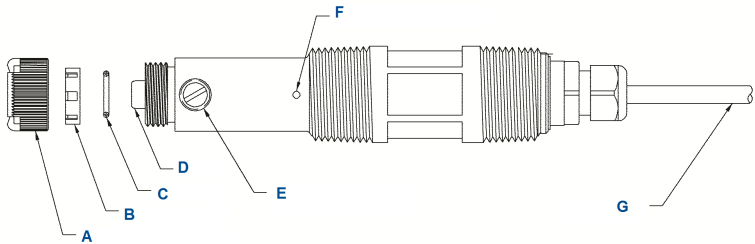

- A. Membrane retainer
- B. Membrane assembly
- C. O-ring
- D. Cathode
- E. Electrolyte fill plug (wrap with pipe tape)
- F. Pressure equalizing port
- G. Sensor cable (integral cable shown)

1.3 Specifications

Table 1-1: Sensor Specifications

Physical characteristics	Specifications
Range	0 to 3 ppm (mg/L) as O ₃
Pressure	0 to 65 psig (101 to 549 kPa abs)
Temperature (operating)	32 to 122 °F (0 to 50 °C)
Process connection	1-in. male national pipe thread (MNPT)

Table 1-1: Sensor Specifications (continued)

Physical characteristics	Specifications
Wetted parts	Polysulfone, Viton®, Teflon®, and silicone
Cathode	Gold (not normally wetted)
Accuracy	Accuracy depends on the accuracy of the chemical test used to calibrate the sensor.
Linearity	±5% of reading or ±3 ppb (whichever is greater) at 77 °F (25 °C)
Repeatability	±2% of reading at constant temperature
Response time	30< 20 sec to 90% of final reading at 77 °F (25 °C)
Membrane permeability connection	Defined between 32 and 122 °F (0 and 50 °C)
Electrolyte volume	0.8 oz. (25 mL), approximately
Electrolyte life	3 months (approximately); for best results, replace electrolyte monthly.
Cable length	See <i>Ordering information</i> table in the Product Data Sheet for cable length options.
Cable length (maximum)	300 ft. (91 m), up to 100 ft. (30.5 m) is standard.
Sample flow	Flow through: 1 to 5 gpm (3.8 to 19 L/min) Open channel: 1 ft./sec (0.3 m/sec) Low flow cell: 2 to 5 gph (7.6 to 19 L/hr)
Weight/shipping weight ⁽¹⁾	1 lb./3 lb. (0.5 kg/1.5 kg)

(1) Weights and shipping weights are rounded up to the nearest whole pound or 0.5 kg.

Table 1-2: Other Specifications

Type	PN	Wetted materials	Process connection	Maximum temperature	Maximum pressure
2-in. tee	915240-03	PVC and Buna N; body is schedule 80 PVC	¾-in. NFPT	120 °F (49 °C)	60 psig (515 kPa abs)
	915240-04		1-in. NFPT		
	915240-05		1½-in. NFPT		
Low flow cell ⁽¹⁾	24091-00 and 24091-01	Polycarbonate/polyester, 316 stainless steel, and silicone	Compression fitting for ¼-in. O.D. tubing or ¼-in. female national pipe thread (FNPT)	158 °F (70 °C)	90 psig (722 kPa abs)

Table 1-2: Other Specifications (continued)

Type	PN	Wetted materials	Process connection	Maximum temperature	Maximum pressure
Valved rotameter	9390004 for use with low flow cell Flow: 0.5 to 5 gph (1.4 to 19 L/hr)	Acrylic, 316 stainless steel, and Viton	¼-in. NFPT (316 stainless steel)	150 °F (65 °C)	100 psig (858 kPa abs)

- (1) *Temperature and pressure specifications for the low flow cell exceed the temperature and pressure specifications for the sensor.*

2 Install

Install the sensor in a flowing sample. Keep the sample flow as constant as possible at a value within the following limits:

Sample flow unit	Flow limits
Flow through	1 to 5 gpm (3.8 to 19 L/min)
Open channel	1 ft/sec (0.3 m/sec)
Low flow cell	2 to 5 gph (7.6 to 19 L/hr)

Figure 2-1: Sensor Orientation

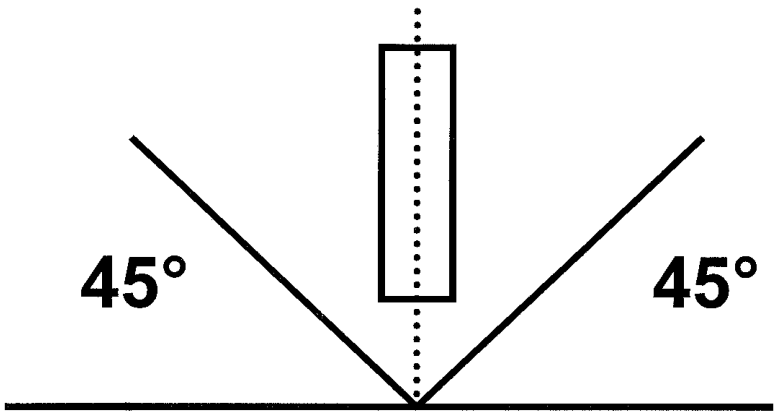

Install sensor within 45 degrees of vertical.

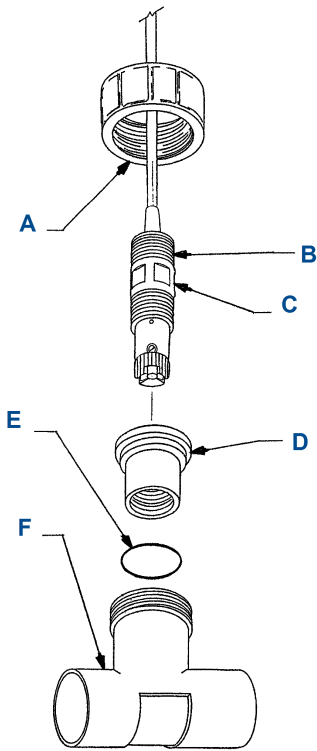
Figure 2-2: Flow Through 1½-in. Tee

- A. Union coupler
- B. 1-in. national pipe thread (NPT), two places
- C. Sensor body: Rosemount 499A
- D. 1-in. NPT flow cell adapter
- E. O-ring 2-222
- F. 1½-in. sched 80 CPVC tee body

Figure 2-3: Flow Through 2-in. Tee

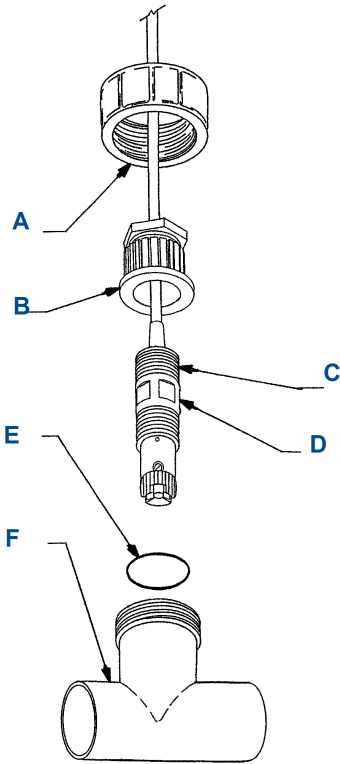

- A. Union coupler
- B. Adapter
- C. 1-in. NPT (two places)
- D. Sensor body: Rosemount 499A
- E. O-ring 2-222
- F. 2-in. sched 80 PVC tee body

Figure 2-4: Low Flow Cell (PN 24091-00)

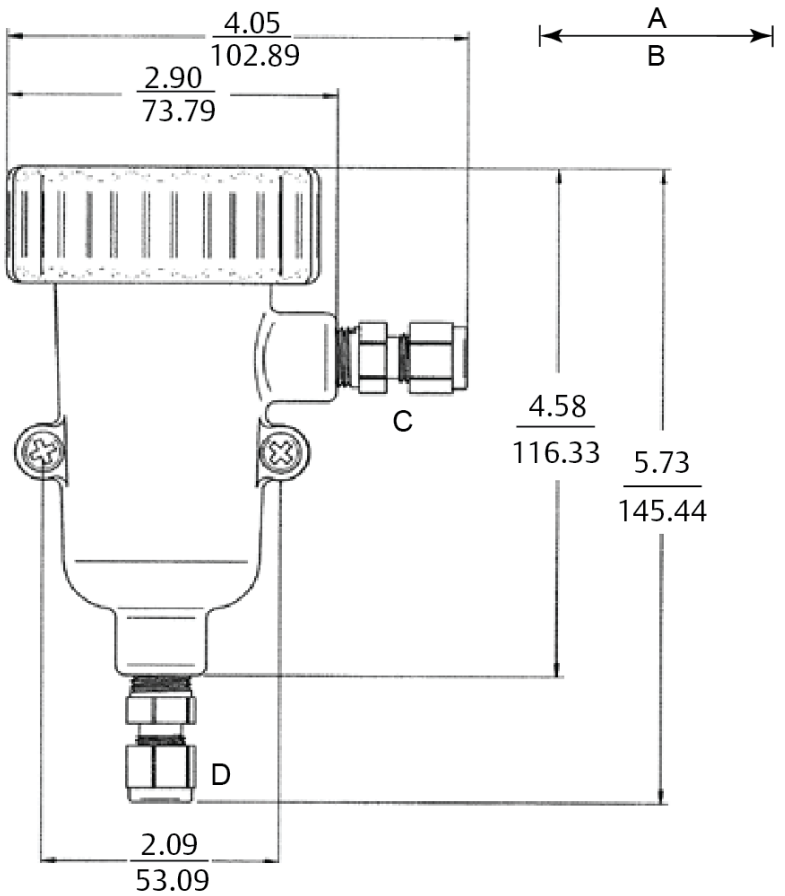

- A. Inches
- B. Millimeters
- C. Outlet
- D. Inlet

3 Wire

NOTICE

For additional wiring information on this product, including sensor combinations not shown here, please refer to the [Liquid Transmitter Wiring Diagrams](#).

Figure 3-1: Rosemount 499AOZ Sensor Wiring to Rosemount 1056 and 56 Transmitters

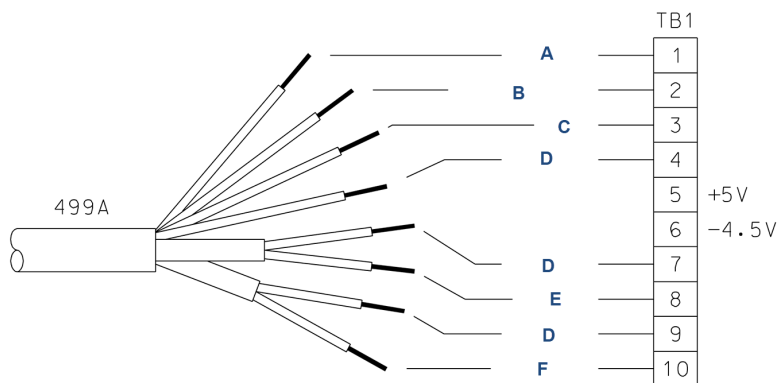

Table 3-1: Rosemount 499AOZ Sensor Wiring to Rosemount 1056 and 56 Transmitters

Terminal number	Letter	Wire color	Description
1	A	White	Resistance temperature device (RTD) return
2	B	White/red	RTD sense
3	C	Red	RTD in
4	D	Clear	RTD shield
5	N/A	N/A	+5 V out
6	N/A	N/A	-4.5 V out
7	D	Clear	Anode shield
8	E	Gray	Anode
9	D	Clear	Cathode shield

Table 3-1: Rosemount 499AOZ Sensor Wiring to Rosemount 1056 and 56 Transmitters (continued)

Terminal number	Letter	Wire color	Description
10	F	Orange	Cathode

Figure 3-2: Rosemount 499AOZ Sensor Wiring to Rosemount 5081 Transmitter

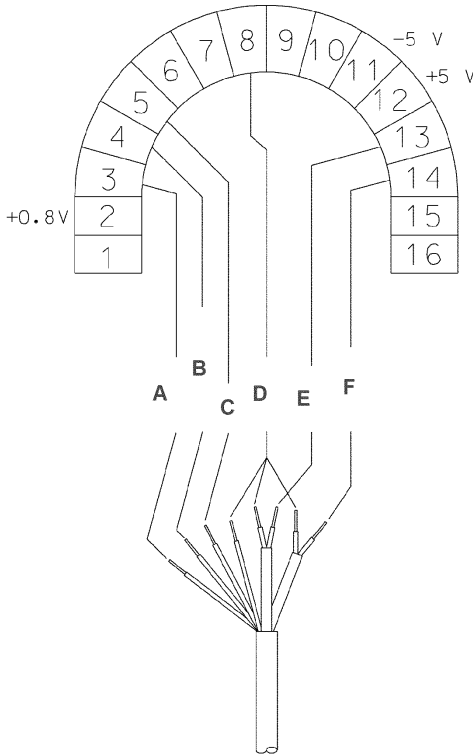

Table 3-2: Rosemount 499AOZ Sensor Wiring to Rosemount 5081 Transmitter

Terminal number	Letter	Wire color	Description
1	N/A	N/A	N/A
2	N/A	N/A	+0.8 V
3	A	White	RTD return

Table 3-2: Rosemount 499AOZ Sensor Wiring to Rosemount 5081 Transmitter
(continued)

Terminal number	Letter	Wire color	Description
4	B	White/red	RTD sense
5	C	Red	RTD in
6	N/A	N/A	Reference guard
7	N/A	N/A	Reference in
8	D	Clear	Solution ground
9	N/A	N/A	pH guard
10	N/A	N/A	pH in
11	N/A	N/A	-5 V
12	N/A	N/A	+5 V
13	E	Gray	Anode
14	F	Orange	Cathode
15	N/A	N/A	HART [®] /FOUNDATION [™] Fieldbus (-)
16	N/A	N/A	HART/FOUNDATION Fieldbus (+)

Figure 3-3: Rosemount 499AOZ Sensor Wiring to Rosemount 1066 Transmitter

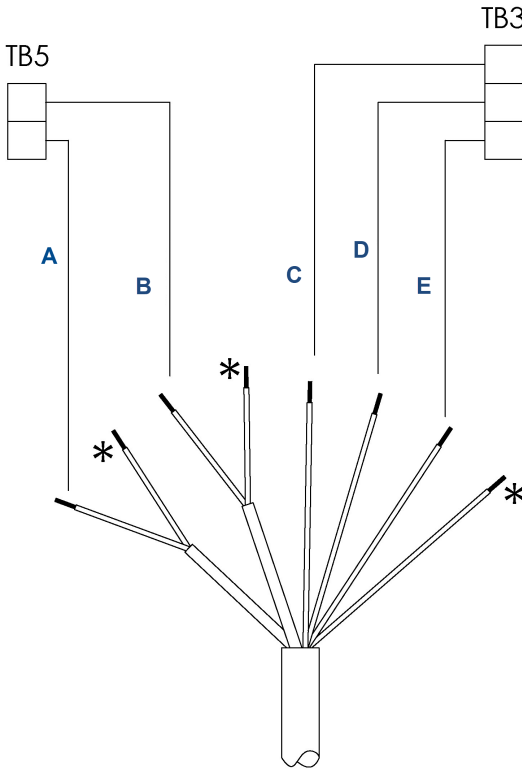

Note

Connect clear shield wires to solution ground terminal on TB 2. Use wire nut and pigtail if necessary.

Table 3-3: Rosemount 499AOZ Wiring to Rosemount 1066 Transmitter

Letter	Color	Terminal description
A	Orange	Cathode
B	Gray	Anode
C	White	Return
D	White/red	Sense
E	Red	RTD in

Figure 3-4: Rosemount 499AOZ Sensor Pin-out Diagram

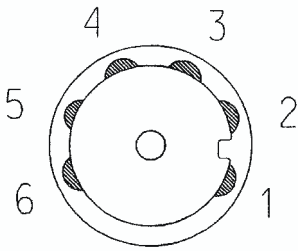

Table 3-4: Pin-out Diagram

Terminal number	Description
1	Cathode
2	N/A
3	RTD sense
4	Anode
5	RTD return
6	RTD in

When making a connection through a junction box (PN 23550-00), wire point-to-point.

NOTICE

Use a wire nut and pigtail (included) when connecting several wires to the same terminal.

4 Calibrate

4.1 Zero point calibration

Even in the absence of ozone, the sensor generates a small signal called the zero current. Failing to correct for the zero current can introduce a bias, particularly if the ozone concentration is small (<0.4 ppm). Zero the sensor when it is first placed in service and every time the fill solution is changed.

To zero the sensor:

Procedure

1. Pour a cup of deionized or bottled water.
2. Place the sensor in the water.
3. Wait until the sensor current has reached a stable low value (at least two hours).
4. Follow the transmitter prompts for zeroing the sensor.

Note

Refer to the manual for the transmitter you are using (Rosemount 56, 1056, 5081, or 1066).

The zero current should be between -10 and +10 nA.

4.2 Full scale calibration

Because stable dilute ozone standards are not available, the sensor must be calibrated against the results of a laboratory test run on a grab sample of the process liquid.

Procedure

1. Place the sensor in the flow cell.
2. Start the sample and reagent flow.
3. Adjust the sample flow to the correct range.
4. Adjust the concentration so that it is near the upper end of the operating range.
5. Wait for the readings to stabilize.
6. Follow the transmitter prompts to complete the calibration.

Note

Refer to the manual for the transmitter you are using (Rosemount 56, 1056, 5081, or 1066).

7. After calibration, go to the **Diagnostics** menu and check the sensitivity.

The sensitivity should be between 250 and 450 nA/ppm. For more information, refer to the transmitter manual.

5 Maintenance

Periodic maintenance and cleaning are required for best performance of the sensor. Generally, the membrane and fill solution should be replaced every four to six months. Sensors installed in harsh or dirty environments require more frequent maintenance. The optimum maintenance frequency is best determined by experience.

⚠ WARNING

Pressurized spray injury

Before removing the sensor, be absolutely certain that the process pressure is reduced to 0 psig and the process temperature is lowered to a safe level!

5.1 Cleaning the membrane

Keep the membrane and sensor tip clean and free from dirt. Clean the membrane with water sprayed from a wash bottle. Use a soft tissue to gently wipe the membrane.

5.2 Replacing the electrolyte solution and membrane

⚠ WARNING

Harmful substance

Fill solution may cause irritation. May be harmful if swallowed.

Read and follow the instructions.

Procedure

1. Unscrew the membrane retainer.
2. Remove the membrane assembly and O-ring.
See [Figure 1-1](#).
3. Hold the sensor over a container with the cathode pointing down.
4. Remove the fill plug.
5. Allow the electrolyte solution to drain out.
6. Inspect the cathode.
 - a) If it is tarnished, clean it by gently rubbing in the direction of the existing scratches (do not use a circular motion) with 400-600 grit silicon carbide finishing paper.
 - b) Rinse thoroughly with water.

7. Remove the old pipe tape from the plug.
8. Wrap the plug with one or two turns of pipe tape..
9. Prepare a new membrane.
 - a) Hold the membrane assembly with the cup formed by the membrane and membrane holder pointing up.
 - b) Fill the cup with electrolyte solution.
 - c) Leave the membrane assembly filled with electrolyte solution and set it aside.
10. Hold the sensor at about a 45 degree angle with the cathode end pointing up.
11. Add electrolyte solution through the fill hole until the liquid overflows.
12. Tap the sensor near the threads to release trapped air bubbles.
13. Add more electrolyte solution if necessary.
14. Place the fill plug in the electrolyte port and begin screwing it in.
15. After several threads have engaged, rotate the sensor so that the cathode is pointing up and continue tightening the fill plug.
Do not overtighten.
16. Place a new O-ring in the groove around the cathode post.
17. Cover the holes at the base of the cathode stem with several drops of electrolyte solution.
18. Insert a small blunt probe, like a toothpick with the end cut off, through the pressure equalizing port.

See [Figure 1-1](#).

CAUTION

Equipment damage

A sharp probe may puncture the bladder and destroy the sensor.

Do not use a sharp probe.

-
19. Gently press the probe against the bladder several times to force liquid through the holes at the base of the cathode stem. Keep pressing the bladder until no air bubbles can be seen leaving the holes.
Be sure the holes remain covered with electrolyte solution.
 20. Place a drop of electrolyte solution on the cathode; then place the membrane assembly over the cathode.
 21. Screw the membrane retainer in place.

The sensor may require several hours operating at the polarizing voltage to equilibrate after the electrolyte solution has been replenished.

6 Accessories

Part number	Description
23747-06	Interconnecting cable, Variopol (VP) 6, 2.5 ft. (0.8 m)
23747-04	Interconnecting cable, VP 6, 4 ft. (1.2 m)
23747-02	Interconnecting cable, VP 6, 10 ft. (3.0 m)
23747-07	Interconnecting cable, VP 6, 15 ft. (4.6 m)
23747-08	Interconnecting cable, VP 6, 20 ft. (6.1 m)
23747-09	Interconnecting cable, VP 6, 25 ft. (7.6 m)
23747-10	Interconnecting cable, VP 6, 30 ft. (9.1 m)
23747-03	Interconnecting cable, VP 6, 50 ft. (15.2 m)
23747-11	Interconnecting cable, VP 6, 100 ft. (30.5 m)
23567-00	1½-in. flow through tee with 1½-in. socket connections
915240-03	2-in. flow through tee with ¾-in. female national pipe thread (FNPT) connections
915240-04	2-in. flow through tee with 1-in. FNPT connections
915240-05	2-in. flow through tee with 1½-in. FNPT connections
24091-00	Low flow cell with ¼-in. OD tubing compression fittings
9390004	Rotameter: 0.5 - 5.0 gph
22550-00	Junction box, 12 terminals
9200266	Extension cable for option -54, unterminated (specify length)
9200275	Extension cable for optimum EMI/RFI cable, unterminated (specify length)
23747-00	Extension cable for optimum EMI/RFI cable, terminated (specify length)
2001492	Stainless steel tag
23501-11	Dissolved ozone membrane assembly; includes 1 membrane assembly and 1 O-ring
23502-11	Dissolved ozone membrane assembly; includes 3 membrane assemblies and 3 O-rings
9210299	#3 Dissolved ozone sensor fill solution, 4 oz (125 ml)
33521-02	Membrane retainer
33523-03	Fill plug



EMERSON AUTOMATION SOLUTIONS

6021 Innovation Blvd.
Shakopee, MN 55379

 +1 866 347 3427

 +1 952 949 7001

 RMTNA.RCCPO@Emerson.com

NORTH AMERICA

Emerson Automation Solutions
8200 Market Blvd
Chanhassen, MN 55317

 Toll Free +1 800 999 9307

 F +1 952 949 7001

 RMTNA.RCCPO@Emerson.com

EUROPE

Emerson Automation Solutions
Neuhofstrasse 19a PO Box 1046
CH-6340 Baar
Switzerland

 +41 (0) 41 768 6111

 +41 (0) 41 768 6300

 RMTNA.RCCPO@Emerson.com

MIDDLE EAST AND AFRICA

Emerson Automation Solutions
Emerson FZE
Jebel Ali Free Zone
Dubai, United Arab Emirates, P.O. Box
17033

 +971 4 811 8100

 +971 4 886 5465

 RMTNA.RCCPO@Emerson.com

ASIA-PACIFIC

Emerson Automation Solutions
1 Pandan Crescent
Singapore 128461
Republic of Singapore

 +65 6 777 8211

 +65 6 777 0947

 RMTNA.RCCPO@Emerson.com

 [Linkedin.com/company/Emerson-Automation-Solutions](https://www.linkedin.com/company/Emerson-Automation-Solutions)

 twitter.com/rosemount_news

 [Facebook.com/Rosemount](https://www.facebook.com/Rosemount)

 [youtube.com/RosemountMeasurement](https://www.youtube.com/RosemountMeasurement)

©2020 Emerson. All rights reserved.

The Emerson logo is a trademark and service mark of Emerson Electric Co. Rosemount is a mark of one of the Emerson family of companies. All other marks are the property of their respective owners.